

Package Outline

0201

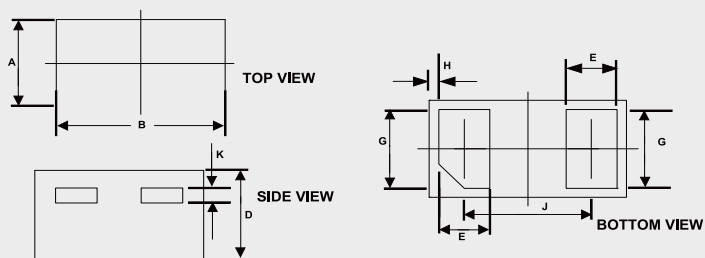

DIM	INCHES		MM		NOTE
	MIN	MAX	MIN	MAX	
A	0.011	0.015	0.270	0.370	
B	0.022	0.026	0.570	0.670	
D	0.011	0.013	0.275	0.340	
E	0.005	0.008	0.125	0.195	
G	0.009	0.012	0.225	0.295	
H	0.001		0.030		REF.
J	0.014	0.017	0.365	0.435	
K	0.002		0.050		REF.

0201-A

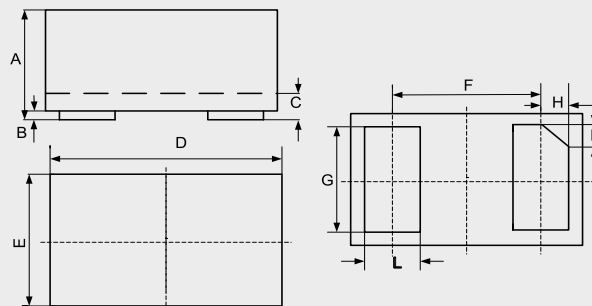
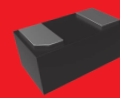

DIM	INCHES		MM		NOTE
	MIN	MAX	MIN	MAX	
A	0.009	0.013	0.23	0.33	
B	0.000	0.002	0.00	0.05	
C	0.005	0.007	0.12	0.18	
D	0.022	0.026	0.55	0.65	
E	0.010	0.014	0.25	0.35	
F	0.014		0.355		REF.
G	0.008	0.011	0.215	0.275	
H	0.003		0.079		REF.
L	0.006	0.009	0.16	0.22	

CSP0201

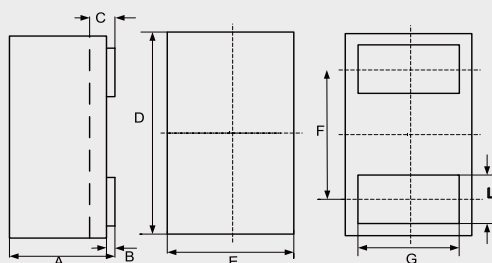
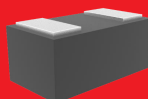

DIM	INCHES		MM		NOTE
	MIN	MAX	MIN	MAX	
A	0.008	0.013	0.21	0.33	
B	0.000	0.002	0.00	0.05	
C	0.005	0.007	0.12	0.18	
D	0.022	0.026	0.55	0.65	
E	0.010	0.014	0.25	0.35	
F	0.014		0.355		TYP.
G	0.008	0.011	0.215	0.28	
L	0.006	0.009	0.16	0.22	

CSP1006-2

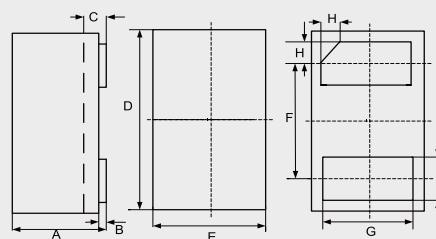
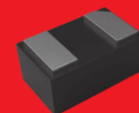

DIM	INCHES		MM		NOTE
	MIN	MAX	MIN	MAX	
A	0.018	0.022	0.45	0.55	
B	0.000	0.002	0.00	0.05	
C	0.005	0.007	0.12	0.18	
D	0.037	0.041	0.95	1.05	
E	0.022	0.026	0.55	0.65	
F	0.026		0.650		TYP.
G	0.018	0.022	0.45	0.55	
H	0.003	0.007	0.07	0.17	
L	0.008	0.012	0.20	0.30	

Package Outline

Package Outline

DFN1006-2

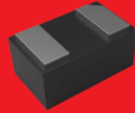

DFN1006-2L

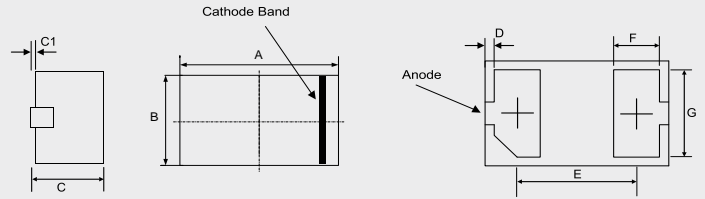
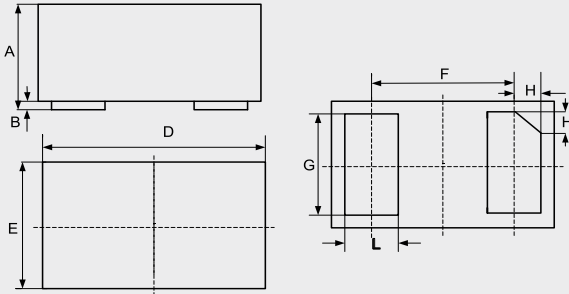

DIM	DIMENSIONS				NOTE
	INCHES		MM		
	MIN	MAX	MIN	MAX	
A	0.013	0.022	0.34	0.55	
B	0.000	0.002	0.00	0.05	
D	0.037	0.043	0.95	1.08	
E	0.022	0.027	0.55	0.68	
F	0.026		0.650		REF.
G	0.016	0.024	0.40	0.60	
H	0.003	0.007	0.07	0.17	
L	0.008	0.012	0.20	0.30	

DIM	DIMENSIONS				NOTE
	INCHES		MM		
	MIN	MAX	MIN	MAX	
A	0.037	0.041	0.95	1.05	
B	0.022	0.026	0.55	0.65	
C	0.016	0.020	0.40	0.50	
C1	---	0.002	---	0.05	
D	0.0004	0.004	0.01	0.09	
E	0.026		0.65		TYP.
F	0.008	0.012	0.20	0.30	
G	0.018	0.022	0.45	0.55	

DFN1006-3

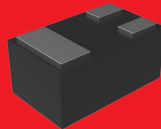

DFN1308-5

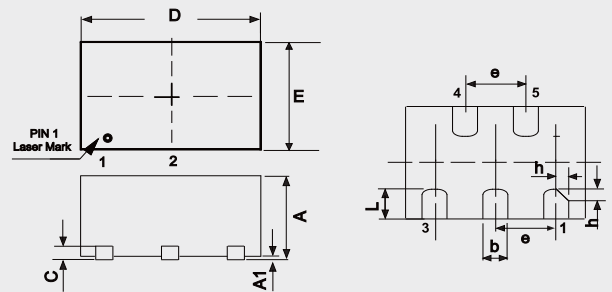
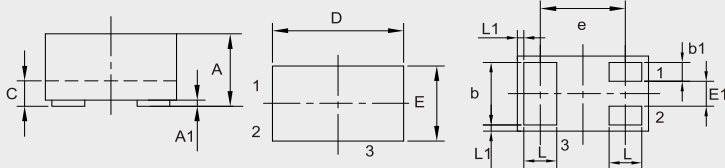

DIM	DIMENSIONS				NOTE
	INCHES		MM		
	MIN	MAX	MIN	MAX	
A	0.018	0.022	0.45	0.55	
A1	0.000	0.002	0.00	0.05	
b	0.018	0.022	0.45	0.55	
b1	0.004	0.008	0.10	0.20	
c	0.005	0.007	0.12	0.18	
D	0.037	0.042	0.95	1.075	
E	0.022	0.026	0.55	0.675	
E1	0.006	0.010	0.15	0.25	
e	0.026		0.65		TYP.
L	0.008	0.012	0.20	0.30	
L1	0.0002		0.05		TYP.

DIM	DIMENSIONS				NOTE
	INCHES		MM		
	MIN	MAX	MIN	MAX	
A	0.015	0.020	0.40	0.50	
A1	0.000	0.002	0.00	0.05	
b	0.006	0.010	0.15	0.25	
C	0.005		0.127		TYP.
D	0.047	0.056	1.20	1.40	
E	0.028	0.036	0.70	0.90	
e	0.020		0.50		TYP.
h	0.004	0.006	0.10	0.15	
L	0.008	0.012	0.20	0.30	

Package Outline

DFN1510-6

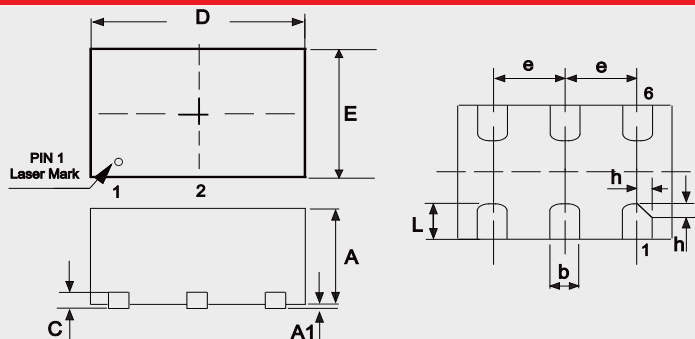

DIMENSIONS					NOTE
DIM	INCHES		MM		
	MIN	MAX	MIN	MAX	
A	0.020	0.024	0.50	0.60	
A1	0.000	0.002	0.00	0.05	
b	0.006	0.010	0.15	0.25	
C	0.006		0.15		TYP.
D	0.055	0.063	1.40	1.60	
E	0.035	0.043	0.90	1.10	
e	0.020		0.50		TYP.
h	0.004	0.006	0.10	0.15	
L	0.014	0.018	0.35	0.45	

DFN1608-2

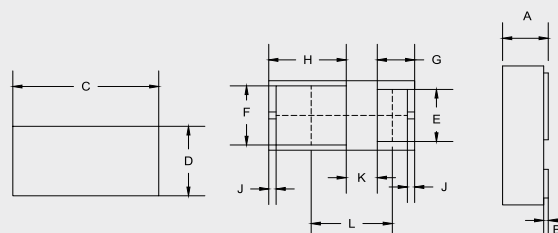
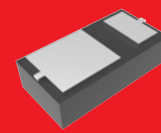

DIMENSIONS					NOTE
DIM	INCHES		MM		
	MIN	MAX	MIN	MAX	
A	0.018	0.022	0.45	0.55	
B	0.000	0.004	0.01	0.09	
C	0.061	0.065	1.55	1.65	
D	0.030	0.033	0.75	0.85	
E	0.020	0.027	0.52	0.68	
F	0.024	0.030	0.60	0.76	
G	0.016		0.41		REF.
H	0.033		0.85		REF.
J	0.003		0.08		REF.
K	0.013		0.34		REF.
L	0.035	0.039	0.90	1.00	

DFN1610-2

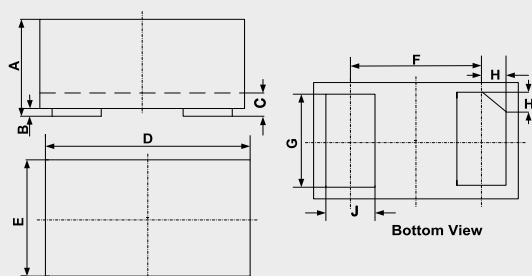
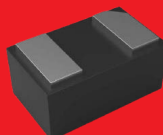

DIMENSIONS					NOTE
DIM	INCHES		MM		
	MIN	MAX	MIN	MAX	
A	0.018	0.022	0.45	0.55	
B	0.000	0.002	0.00	0.05	
C	0.004	0.008	0.10	0.20	
D	0.062	0.066	1.55	1.65	
E	0.038	0.042	0.95	1.05	
F	0.044		1.10		TYP.
G	0.030	0.034	0.75	0.85	
H	0.006	0.010	0.15	0.25	
J	0.014	0.018	0.35	0.45	

DFN1610-6

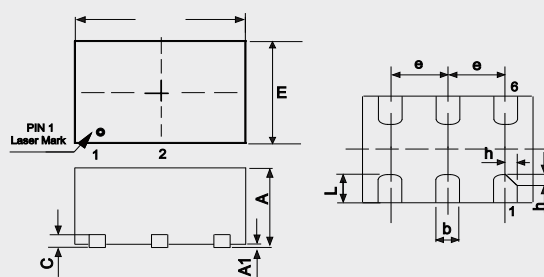
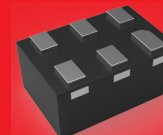

DIMENSIONS					NOTE
DIM	INCHES		MM		
	MIN	MAX	MIN	MAX	
A	0.028	0.032	0.70	0.80	
A1	0.000	0.002	0.00	0.05	
b	0.006	0.010	0.17	0.25	
c	0.006	0.010	0.15	0.25	
D	0.061	0.065	1.55	1.65	
E	0.035	0.043	0.90	1.10	
L	0.008	0.012	0.20	0.30	
e	0.020		0.50		TYP.
h	0.003	0.005	0.08	0.12	

Package Outline

Package Outline

DFN1616-6

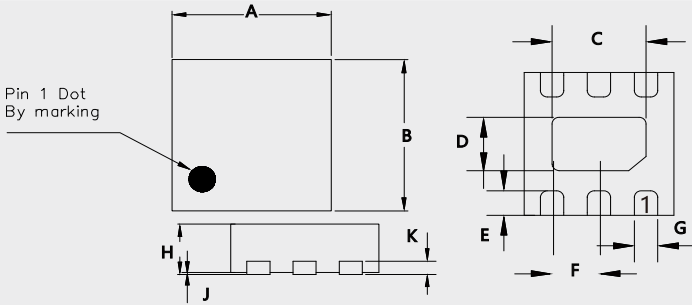

DIMENSIONS					
DIM	INCHES		MM		NOTE
	MIN	MAX	MIN	MAX	
A	0.061	0.065	1.55	1.65	
B	0.061	0.065	1.55	1.65	
C	0.035	0.041	0.90	1.05	
D	0.020	0.026	0.50	0.65	
E	0.008	0.012	0.20	0.30	
F	0.020		0.50		TYP.
G	0.008	0.012	0.20	0.30	
H	0.020	0.024	0.50	0.60	
J	0.000	0.002	0.00	0.05	
K	0.006		0.15		TYP.

DFN1616-6L

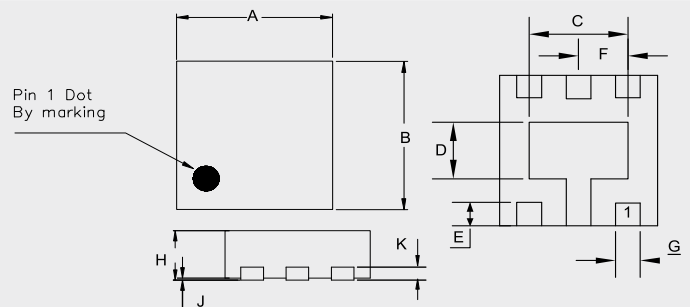
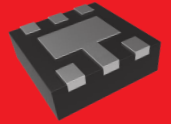

DIMENSIONS					
DIM	INCHES		MM		NOTE
	MIN	MAX	MIN	MAX	
A	0.061	0.065	1.55	1.65	
B	0.061	0.065	1.55	1.65	
C	0.034	0.043	0.85	1.10	
D	0.018	0.028	0.45	0.70	
E	0.008	0.012	0.20	0.30	
F	0.020		0.50		TYP.
G	0.008	0.012	0.20	0.30	
H	0.020	0.024	0.50	0.60	
J	0.000	0.002	0.00	0.05	
K	0.006		0.15		TYP.

DFN2020-3A

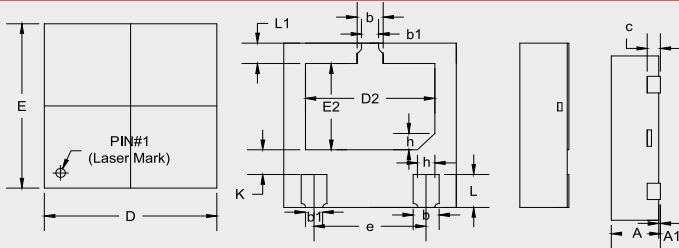
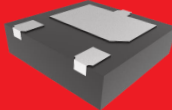

DIMENSIONS					
DIM	INCHES		MM		NOTE
	MIN	MAX	MIN	MAX	
A	0.020	0.024	0.50	0.60	
A1	0.000	0.002	0.00	0.05	
b	0.010	0.014	0.25	0.35	
b1	0.008		0.20		TYP.
c	0.006		0.15		TYP.
D	0.075	0.083	1.90	2.10	
D2	0.055	0.063	1.40	1.60	
e	0.051		1.30		TYP.
E	0.075	0.083	1.90	2.10	
E2	0.037	0.045	0.95	1.15	
L	0.014	0.018	0.35	0.45	
L1	0.008	0.012	0.20	0.30	
h	0.008		0.20		TYP.
K	0.008	0.016	0.20	0.40	

DFN2020-3L

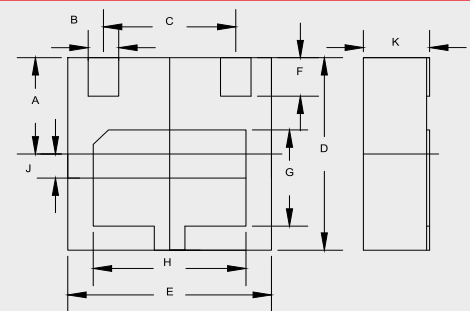
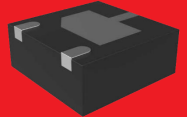

DIMENSIONS					
DIM	INCHES		MM		NOTE
	MIN	MAX	MIN	MAX	
A	0.037	0.041	0.950	1.050	
B	0.010	0.014	0.250	0.350	
C	0.051		1.30		TYP.
D	0.075	0.083	1.900	2.100	
E	0.075	0.083	1.900	2.100	
F	0.014	0.018	0.350	0.450	
G	0.035	0.043	0.900	1.100	
H	0.055	0.063	1.400	1.600	
J	0.008	0.012	0.200	0.300	
K	-	0.026	-	0.650	

Package Outline

DFN2020-6JA

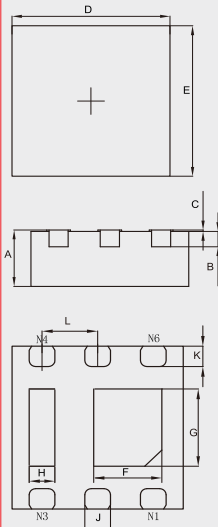

DIM	INCHES		MM		NOTE
	MIN	MAX	MIN	MAX	
A	0.028	0.032	0.700	0.800	
B	0.006		0.150		REF.
C	0.000	0.002	0.000	0.050	
D	0.077	0.081	1.950	2.050	
E	0.077	0.081	1.950	2.050	
F	0.024	0.031	0.610	0.810	
G	0.028	0.036	0.710	0.910	
H	0.008	0.016	0.200	0.400	
J	0.010	0.014	0.250	0.350	
K	0.008	0.012	0.200	0.300	
L	0.026		0.650		TYP.

DFN2020-6L

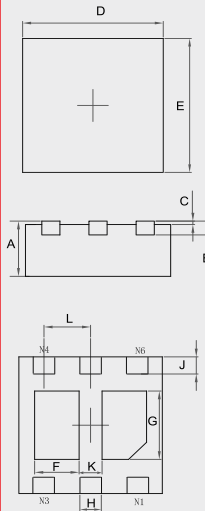
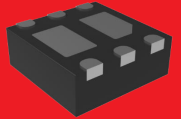

DIM	INCHES		MM		NOTE
	MIN	MAX	MIN	MAX	
A	0.030	0.034	0.750	0.850	
B	0.008		0.200		TYP.
C	0.000	0.002	0.000	0.050	
D	0.077	0.081	1.950	2.050	
E	0.077	0.081	1.950	2.050	
F	0.017	0.027	0.440	0.690	
G	0.033	0.043	0.840	1.090	
H	0.010	0.014	0.250	0.350	
J	0.007	0.015	0.175	0.375	
K	0.010	0.014	0.250	0.350	
L	0.026		0.650		TYP.

DFN2020-6LE

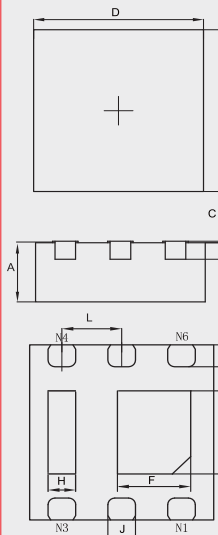
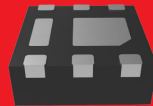

DIM	INCHES		MM		NOTE
	MIN	MAX	MIN	MAX	
A	0.028	0.035	0.700	0.900	
B	0.008		0.200		REF.
C	0.000	0.004	0.000	0.100	
D	0.075	0.083	1.900	2.100	
E	0.075	0.083	1.900	2.100	
F	0.024	0.031	0.610	0.810	
G	0.028	0.036	0.710	0.910	
H	0.008	0.016	0.200	0.400	
J	0.008	0.016	0.200	0.400	
K	0.006	0.014	0.150	0.350	
L	0.026		0.650		TYP.

DFN2626-10

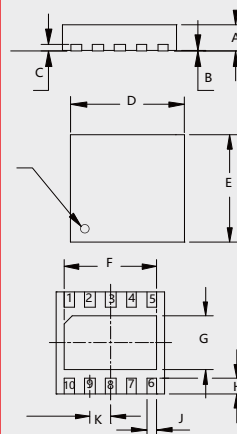
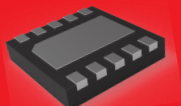

DIM	INCHES		MM		NOTE
	MIN	MAX	MIN	MAX	
A	0.020	0.024	0.50	0.60	
B	0.000	0.002	0.00	0.05	
C	0.007		0.17		TYP.
D	0.098	0.106	2.50	2.70	
E	0.098	0.106	2.50	2.70	
F	0.079	0.089	2.00	2.25	
G	0.044	0.054	1.11	1.36	
H	0.012	0.016	0.30	0.40	
J	0.008	0.012	0.20	0.30	
K	0.020		0.50		TYP.

Package Outline

Package Outline

DFN3333

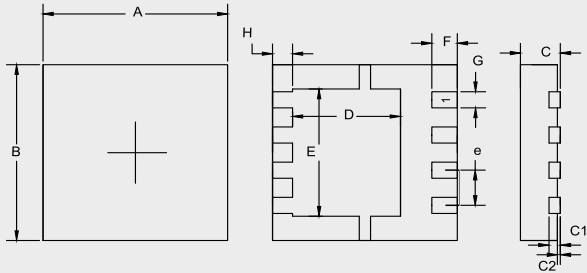
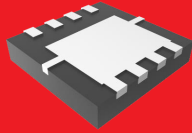

DIM	INCHES		MM		NOTE
	MIN	MAX	MIN	MAX	
A	0.126	0.130	3.20	3.30	
B	0.126	0.130	3.20	3.30	
C	0.030	0.033	0.75	0.85	
C1	0.007	0.009	0.18	0.22	
C2	---	0.002	---	0.05	
D	0.071	0.079	1.80	2.00	
E	0.087	0.098	2.20	2.50	
F	0.016	0.020	0.40	0.50	
G	0.010	0.014	0.25	0.35	
H	0.012	0.016	0.30	0.40	
e	0.024	0.028	0.60	0.70	

DFN3333-D

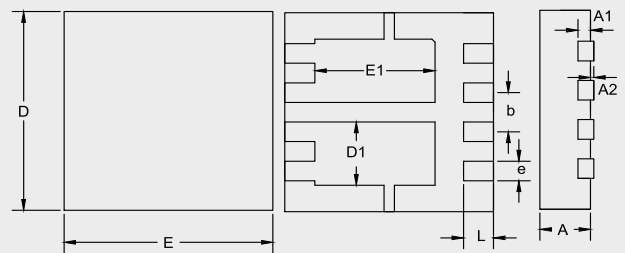
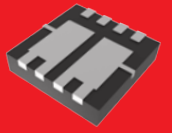

DIM	INCHES		MM		NOTE
	MIN	MAX	MIN	MAX	
A	0.030	0.033	0.750	0.850	
A1	0.008		0.200		TYP
A2	-	0.002	-	0.050	
D	0.128	0.132	3.250	3.350	
E	0.128	0.132	3.250	3.350	
D1	0.039	0.043	1.000	1.100	
E1	0.073	0.077	1.850	1.950	
e	0.026		0.650		BSC
b	0.012	0.014	0.300	0.350	
L	0.017	0.021	0.425	0.525	

DFN4120-10

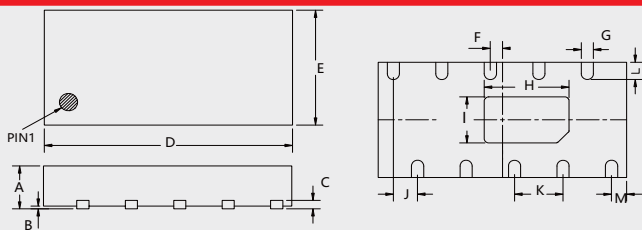
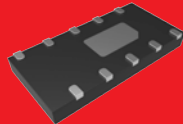

DIM	INCHES		MM		NOTE
	MIN	MAX	MIN	MAX	
A	0.020	0.024	0.50	0.60	
B	0.000	0.002	0.00	0.05	
C	0.006		0.150		TYP.
D	0.162	0.166	4.05	4.15	
E	0.075	0.082	1.95	2.05	
F	0.008		0.200		TYP.
G	0.006	0.010	0.15	0.25	
H	0.050	0.060	1.25	1.50	
I	0.026	0.036	0.65	0.90	
J	0.016		0.40		TYP.
K	0.032		0.80		TYP.
L	0.008	0.016	0.20	0.40	
M	0.010		0.25		TYP.

DFN5060

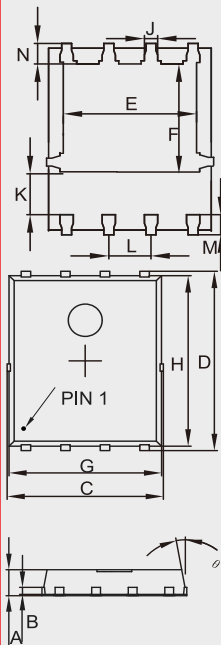
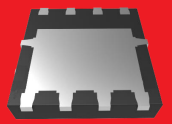

DIM	INCHES		MM		NOTE
	MIN	MAX	MIN	MAX	
A	0.031	0.047	0.80	1.20	
B	0.010		0.254		TYP.
C	0.193	0.222	4.90	5.64	
D	0.232	0.250	5.90	6.35	
E	0.148	0.167	3.75	4.25	
F	0.126	0.154	3.20	3.92	
G	0.189	0.213	4.80	5.40	
H	0.222	0.239	5.65	6.06	
K	0.045	0.059	1.15	1.50	
J	0.012	0.020	0.30	0.50	
L	0.046	0.054	1.17	1.37	
M	0.012	0.028	0.30	0.71	
N	0.016	0.028	0.40	0.71	

Package Outline

DFN8080A

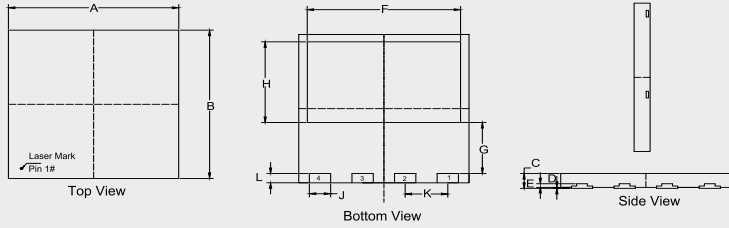
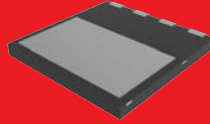

DIM	DIMENSIONS				NOTE
	INCHES		MM		
	MIN	MAX	MIN	MAX	
A	0.311	0.319	7.90	8.10	
B	0.311	0.319	7.90	8.10	
C	0.030	0.037	0.75	0.95	
D	0.000	0.002	0.00	0.05	
E	0.004	0.012	0.10	0.30	
F	0.280	0.287	7.10	7.30	
G	0.104	0.112	2.65	2.85	
H	0.167	0.175	4.25	4.45	
J	0.035	0.043	0.90	1.10	
K	0.079		2.00		BSC
L	0.016	0.024	0.40	0.60	

DFN-10

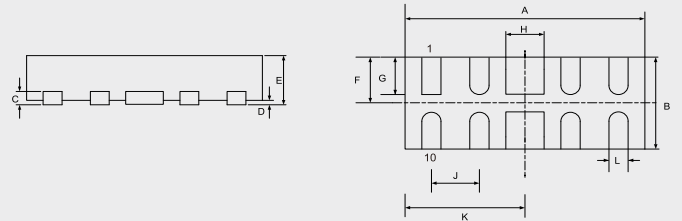
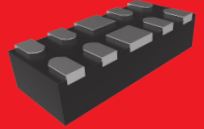

DIM	DIMENSIONS				NOTE
	INCHES		MM		
	MIN	MAX	MIN	MAX	
A	0.094	0.102	2.40	2.60	
B	0.035	0.043	0.90	1.10	
C	0.005		0.13		TYP.
D	0.000	0.002	0.00	0.05	
E	0.020	0.026	0.50	0.65	
F	0.017	0.022	0.45	0.55	
G	0.012	0.017	0.30	0.425	
H	0.014	0.018	0.35	0.45	
J	0.020		0.50		TYP.
K	0.047	0.056	1.20	1.30	
L	0.006	0.010	0.15	0.25	

D²-PAK

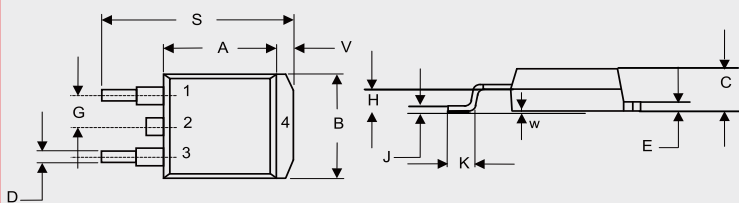
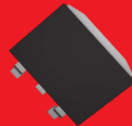

DIM	DIMENSIONS				NOTE
	INCHES		MM		
	MIN	MAX	MIN	MAX	
A	0.331	0.370	8.40	9.40	
B	0.378	0.417	9.60	10.60	
C	0.165	0.189	4.20	4.80	
D	0.027	0.037	0.68	0.94	
E	0.045	0.055	1.14	1.40	
G	0.010		2.54		TYP.
H	0.096	0.134	2.43	3.40	
J	0.011	0.025	0.28	0.64	
K	0.071	0.131	1.80	3.32	
S	0.575	0.625	14.60	15.87	
V	0.042	0.058	1.07	1.47	
W	0.000	0.010	0.00	0.25	

DPAK

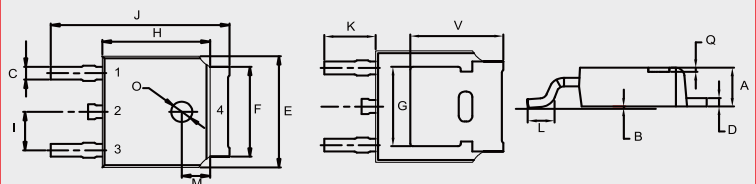

DIM	DIMENSIONS				NOTE
	INCHES		MM		
	MIN	MAX	MIN	MAX	
A	0.087	0.094	2.20	2.40	
B	0.000	0.005	0.00	0.13	
C	0.026	0.034	0.66	0.86	
D	0.018	0.023	0.46	0.58	
E	0.256	0.264	6.50	6.70	
F	0.201	0.215	5.10	5.46	
G	0.190		4.83		TYP.
H	0.236	0.244	6.00	6.20	
I	0.086	0.094	2.18	2.39	
J	0.386	0.409	9.80	10.40	
K	0.114		2.90		TYP.
L	0.055	0.067	1.40	1.70	
M	0.063		1.60		TYP.
O	0.043	0.051	1.10	1.30	
Q	0.000	0.012	0.00	0.30	
V	0.211		5.35		TYP.

Package Outline

Package Outline

DO-218AB

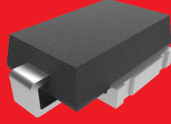

DO-221AC

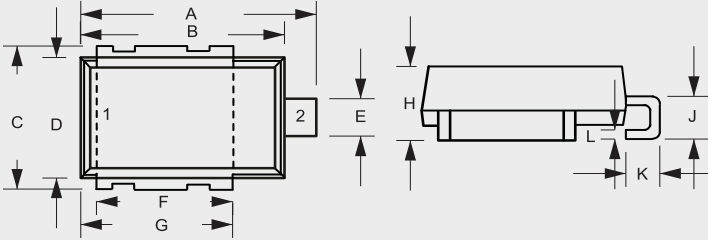
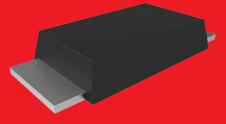

DIMENSIONS					
DIM	INCHES		MM		NOTE
	MIN	MAX	MIN	MAX	
A	0.590	0.630	15.00	16.00	
B	0.524	0.539	13.30	13.70	
C	0.374	0.413	9.50	10.50	
D	0.323	0.339	8.20	8.60	
E	0.091	0.114	2.30	2.90	
F	0.343	0.366	8.70	9.30	
G	0.382	0.406	9.70	10.30	
H	0.189	0.205	4.80	5.20	
J	0.098	0.138	2.50	3.50	
K	0.067	0.106	1.70	2.70	
L	0.020	0.028	0.50	0.70	

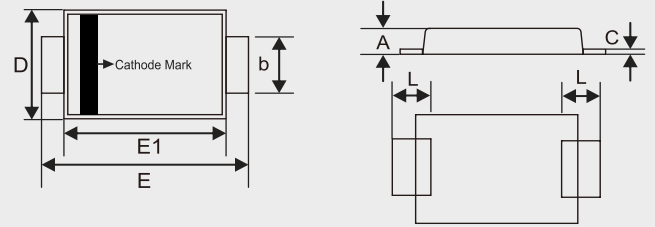

DIMENSIONS					
DIM	INCHES		MM		NOTE
	MIN	MAX	MIN	MAX	
A	0.035	0.049	0.90	1.25	
B	0.049	0.065	1.25	1.65	
C	0.004	0.016	0.10	0.40	
D	0.089	0.116	2.25	2.95	
E	0.173	0.220	4.40	5.60	
E1	0.126	0.181	3.20	4.60	
L	0.020	0.059	0.50	1.50	

SMA



SMAE

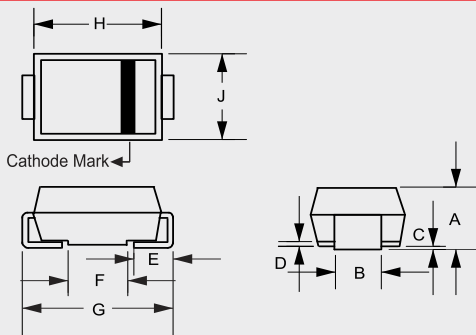
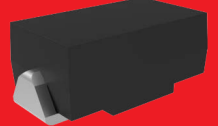

DIMENSIONS					
DIM	INCHES		MM		NOTE
	MIN	MAX	MIN	MAX	
A	0.075	0.096	1.90	2.44	
B	0.050	0.064	1.27	1.63	
C	0.002	0.008	0.051	0.203	
D	—	0.020	—	0.51	
E	0.030	0.060	0.76	1.52	
F	0.065	0.091	1.65	2.32	
G	0.189	0.220	4.80	5.59	
H	0.157	0.187	4.00	4.75	
J	0.090	0.115	2.25	2.92	

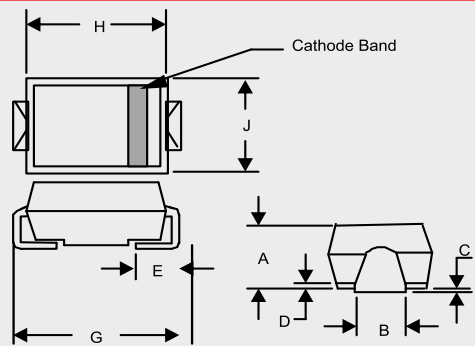

DIMENSIONS					
DIM	INCHES		MM		NOTE
	MIN	MAX	MIN	MAX	
A	0.079	0.096	2.01	2.44	
B	0.045	0.071	1.15	1.80	
C	0.002	0.008	0.05	0.20	
D	—	0.020	—	0.51	
E	0.030	0.060	0.76	1.52	
F	0.065	0.084	1.65	2.13	
G	0.189	0.208	4.80	5.30	
H	0.157	0.180	4.00	4.57	
J	0.090	0.115	2.29	2.92	

Package Outline

SMB

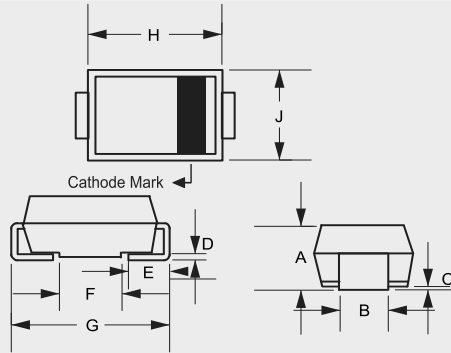
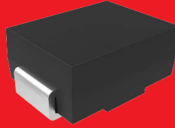

DIMENSIONS					
DIM	INCHES		MM		NOTE
	MIN	MAX	MIN	MAX	
A	0.079	0.103	2.00	2.62	
B	0.075	0.087	1.91	2.21	
C	0.002	0.008	0.05	0.20	
D	0.006	0.012	0.15	0.31	
E	0.030	0.060	0.76	1.52	
F	0.065	0.091	1.65	2.32	
G	0.200	0.220	5.08	5.59	
H	0.160	0.191	4.06	4.85	
J	0.130	0.155	3.30	3.94	

SMBF

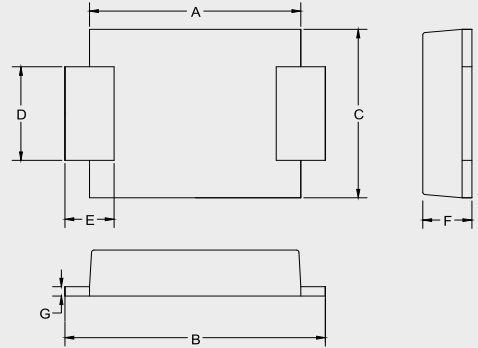
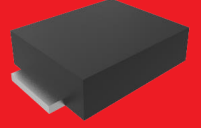

DIMENSIONS					
DIM	INCHES		MM		NOTE
	MIN	MAX	MIN	MAX	
A	0.150	0.165	3.80	4.20	
B	0.197	0.213	5.00	5.40	
C	0.130	0.146	3.30	3.70	
D	0.073	0.085	1.85	2.15	
E	0.018	0.037	0.45	0.95	
F	0.045	0.055	1.15	1.40	
G	0.008	0.014	0.20	0.35	

SMC

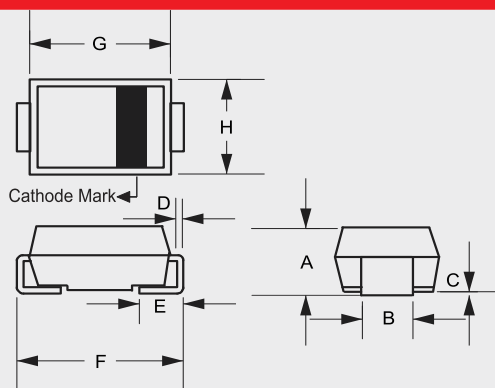
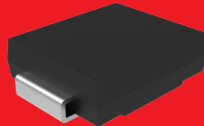

DIMENSIONS					
DIM	INCHES		MM		NOTE
	MIN	MAX	MIN	MAX	
A	0.079	0.103	2.00	2.62	
B	0.108	0.128	2.75	3.25	
C	0.002	0.008	0.051	0.203	
D	0.006	0.012	0.152	0.305	
E	0.030	0.060	0.76	1.52	
F	0.305	0.320	7.75	8.13	
G	0.260	0.280	6.60	7.11	
H	0.220	0.245	5.59	6.22	

SME

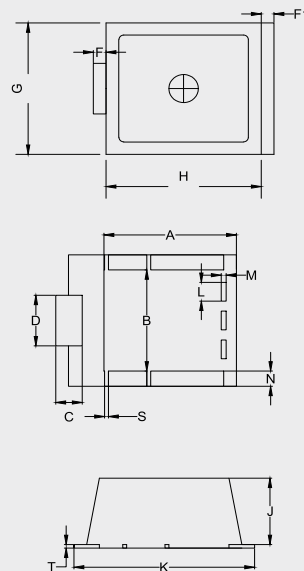
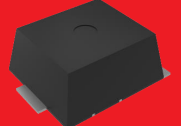

DIMENSIONS					
DIM	INCHES		MM		NOTE
	MIN	MAX	MIN	MAX	
A	0.518	0.542	13.16	13.76	
B	0.415	0.435	10.55	11.05	
C	0.098	0.114	2.50	2.90	
D	0.203	0.222	5.15	5.65	
F	0.047	0.055	1.20	1.40	
F1	0.047	0.055	1.20	1.40	
G	0.530	0.575	13.45	14.60	
H	0.610	0.632	15.50	16.05	
J	0.273	0.285	6.94	7.24	
K	0.713	0.728	18.10	18.50	
L	0.075	0.083	1.90	2.10	
M	0.016	0.024	0.40	0.60	
N	0.055	0.063	1.40	1.60	
T	0.013	0.017	0.33	0.43	
S	0.014	0.018	0.35	0.45	

Package Outline

Package Outline

SMG

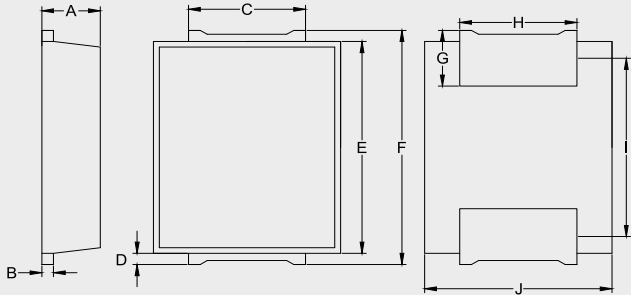
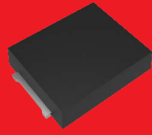

DIM	DIMENSIONS				NOTE
	INCHES		MM		
	MIN	MAX	MIN	MAX	
A	0.096	0.100	2.45	2.55	
B	0.018	0.022	0.45	0.55	
C	0.193	0.201	4.90	5.10	
D	0.016	0.024	0.40	0.60	
E	0.370	0.378	9.40	9.60	
F	0.406	0.421	10.30	10.70	
G	0.094	0.102	2.40	2.60	
H	0.193	0.201	4.90	5.10	
J	0.311	0.319	7.90	8.10	
I	0.311	0.319	7.90	8.10	

SOD-123

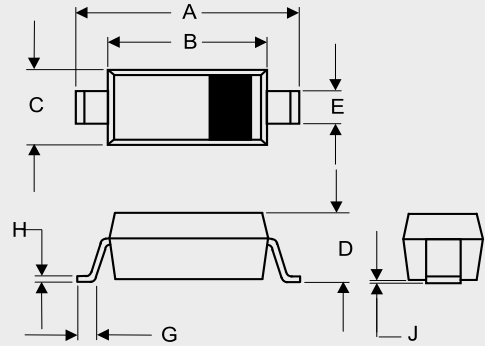
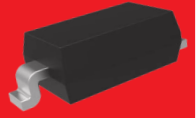

DIM	DIMENSIONS				NOTE
	INCHES		MM		
	MIN	MAX	MIN	MAX	
A	0.140	0.152	3.55	3.85	
B	0.100	0.112	2.55	2.85	
C	0.055	0.071	1.40	1.80	
D	---	0.053	---	1.35	
E	0.018	0.026	0.45	0.65	
G	0.006	---	0.15	---	
H	---	0.010	---	0.25	
J	---	0.006	---	0.15	

SOD-123FL

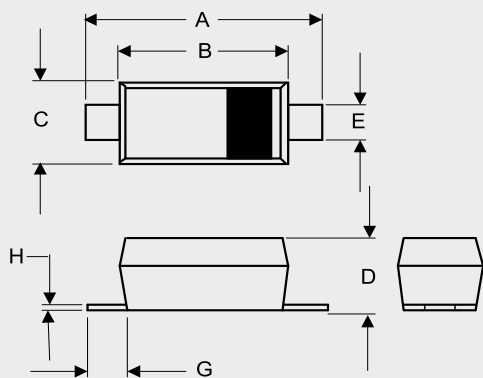

DIM	DIMENSIONS				NOTE
	INCHES		MM		
	MIN	MAX	MIN	MAX	
A	0.130	0.152	3.30	3.85	
B	0.100	0.122	2.55	3.10	
C	0.055	0.075	1.40	1.90	
D	0.035	0.053	0.90	1.35	
E	0.020	0.041	0.50	1.05	
G	0.010	---	0.25	---	
H	---	0.010	---	0.25	

SOD-123HE1

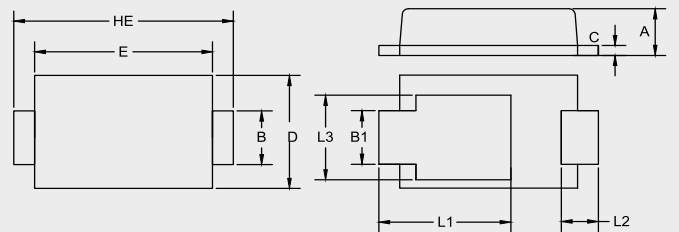

DIM	DIMENSIONS				NOTE
	INCHES		MM		
	MIN	MAX	MIN	MAX	
A	0.030	0.035	0.75	0.90	
B	0.033	0.041	0.85	1.05	
B1	0.033	0.041	0.85	1.05	
C	0.004	0.010	0.10	0.25	
D	0.075	0.083	1.90	2.10	
E	0.114	0.122	2.90	3.10	
L1	0.079	0.096	2.00	2.45	
L2	0.016	0.033	0.40	0.85	
L3	0.051	0.067	1.30	1.70	
HE	0.138	0.154	3.50	3.90	

Package Outline

SOD-323

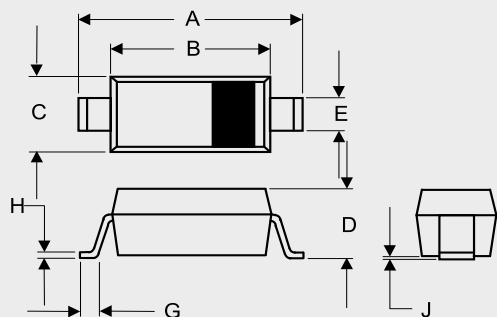
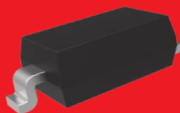

DIMENSIONS					NOTE
DIM	INCHES		MM		
	MIN	MAX	MIN	MAX	
A	0.090	0.107	2.30	2.70	
B	0.063	0.071	1.60	1.80	
C	0.045	0.053	1.15	1.35	
D	0.031	0.045	0.80	1.15	
E	0.010	0.016	0.25	0.40	
G	0.004	0.018	0.10	0.45	
H	0.004	0.010	0.10	0.25	
J	—	0.006	—	0.15	

SOD-323FL

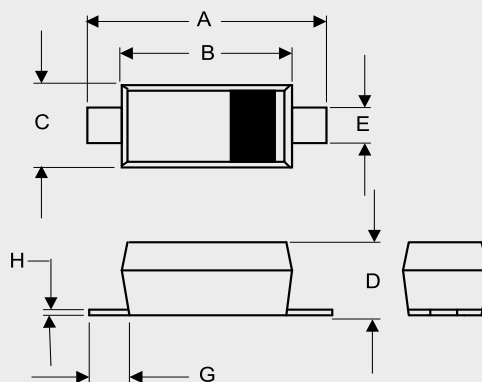
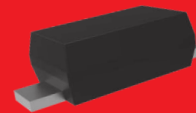

DIMENSIONS					NOTE
DIM	INCHES		MM		
	MIN	MAX	MIN	MAX	
A	0.090	0.107	2.30	2.70	
B	0.063	0.078	1.60	1.95	
C	0.045	0.053	1.15	1.35	
D	0.024	0.035	0.60	0.90	
E	0.010	0.016	0.25	0.40	
G	0.016		0.40		TYP.
H	0.002	0.008	0.05	0.21	

SOD-323HE

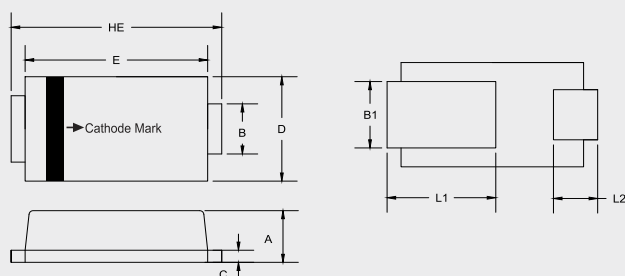
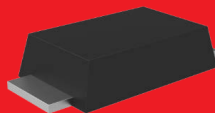

DIMENSIONS					NOTE
DIM	INCHES		MM		
	MIN	MAX	MIN	MAX	
A	0.022	0.030	0.550	0.750	
B	0.021	0.029	0.530	0.730	
B1	0.028	0.036	0.720	0.920	
C	0.004	0.010	0.100	0.250	
D	0.047	0.055	1.200	1.400	
E	0.081	0.089	2.050	2.250	
L1	0.047	0.055	1.200	1.400	
L2	0.016	0.024	0.400	0.600	
HE	0.094	0.102	2.400	2.600	

SOD-523

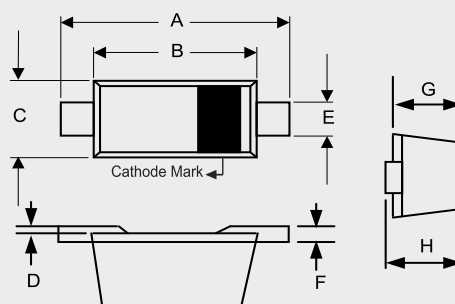
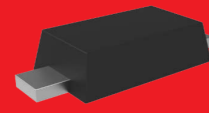

DIMENSIONS					NOTE
DIM	INCHES		MM		
	MIN	MAX	MIN	MAX	
A	0.059	0.067	1.50	1.70	
B	0.043	0.051	1.10	1.30	
C	0.030	0.033	0.75	0.85	
D	0.000	0.003	0.00	0.07	
E	0.010	0.014	0.25	0.35	
F	0.003	0.008	0.08	0.20	
G	0.020	0.026	0.50	0.65	
H	0.020	0.026	0.50	0.65	

Package Outline

Package Outline

SOD-923

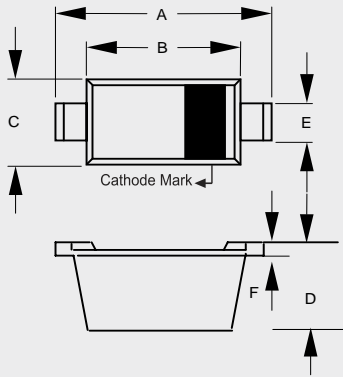
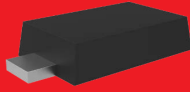

DIM	INCHES		MM		NOTE
	MIN	MAX	MIN	MAX	
A	0.037	0.041	0.95	1.05	
B	0.030	0.033	0.75	0.85	
C	0.022	0.026	0.55	0.65	
D	0.014	0.017	0.36	0.43	
E	0.006	0.010	0.15	0.25	
F	0.003	0.007	0.07	0.17	

SOP-8

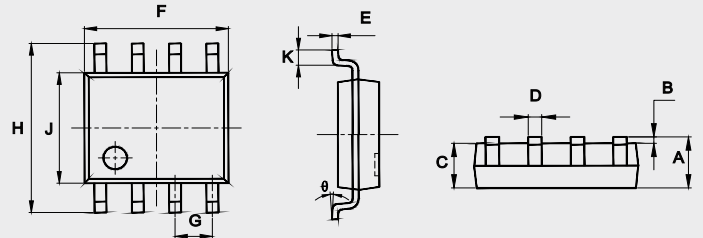
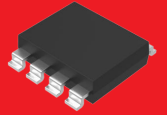

DIM	INCHES		MM		NOTE
	MIN	MAX	MIN	MAX	
A	0.053	0.069	1.35	1.75	
B	0.004	0.010	0.10	0.25	
C	0.053	0.061	1.35	1.55	
D	0.013	0.020	0.33	0.51	
E	0.007	0.010	0.17	0.25	
F	0.185	0.200	4.70	5.10	
G	0.050		1.270		TYP.
H	0.228	0.244	5.80	6.20	
J	0.150	0.157	3.80	4.00	
K	0.016	0.050	0.40	1.27	
θ	0°	8°	0°	8°	

SOT-143

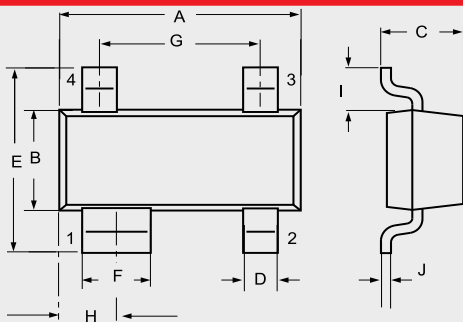
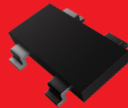

DIM	INCHES		MM		NOTE
	MIN	MAX	MIN	MAX	
A	0.110	0.120	2.80	3.04	
B	0.047	0.055	1.20	1.39	
C	0.031	0.048	0.80	1.22	
D	0.011	0.020	0.30	0.51	
E	0.082	0.104	2.10	2.64	
F	0.029	0.037	0.76	0.94	
G	0.070	0.080	1.78	2.03	
H	0.028	0.033	0.72	0.83	
I	0.015	0.024	0.40	0.60	
J	0.003	0.008	0.08	0.20	

SOT-223

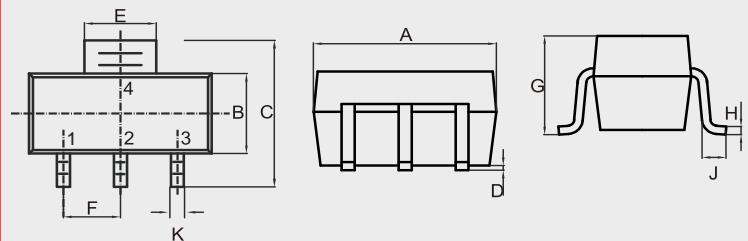
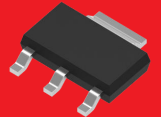

DIM	INCHES		MM		NOTE
	MIN	MAX	MIN	MAX	
A	0.248	0.264	6.30	6.70	
B	0.130	0.146	3.30	3.70	
C	0.264	0.287	6.70	7.30	
D	0.001	0.004	0.02	0.10	
E	0.114	0.122	2.90	3.10	
F	0.091		2.30		TYP.
G	---	0.071	---	1.80	
H	0.009	0.014	0.23	0.35	
J	0.030	---	0.75	---	
K	0.026	0.033	0.66	0.84	

Package Outline

SOT-23

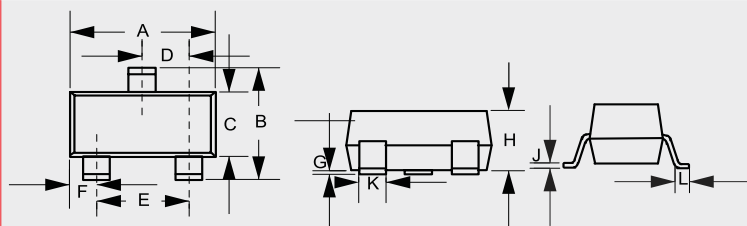

DIMENSIONS					
DIM	INCHES		MM		NOTE
	MIN	MAX	MIN	MAX	
A	0.110	0.120	2.80	3.04	
B	0.083	0.104	2.10	2.64	
C	0.047	0.055	1.20	1.40	
D	0.034	0.041	0.85	1.05	
E	0.067	0.083	1.70	2.10	
F	0.018	0.024	0.45	0.60	
G	0.0004	0.006	0.01	0.15	
H	0.035	0.043	0.90	1.10	
J	0.003	0.007	0.08	0.18	
K	0.012	0.020	0.30	0.51	
L	0.007	0.020	0.20	0.50	

SOT-23-3L

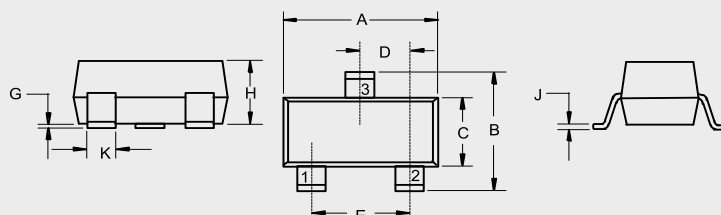
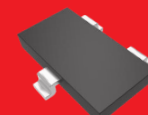

DIMENSIONS					
DIM	INCHES		MM		NOTE
	MIN	MAX	MIN	MAX	
A	0.113	0.117	2.87	2.97	
B	0.108	0.112	2.75	2.85	
C	0.061	0.065	1.55	1.65	
D	0.036	0.038	0.914	0.965	
E	0.073	0.077	1.85	1.95	
G	0.0016	0.0039	0.04	0.100	
H	0.044	0.049	1.12	1.25	
J	0.006	0.007	0.14	0.17	
K	0.013	0.015	0.34	0.37	

SOT23-6L

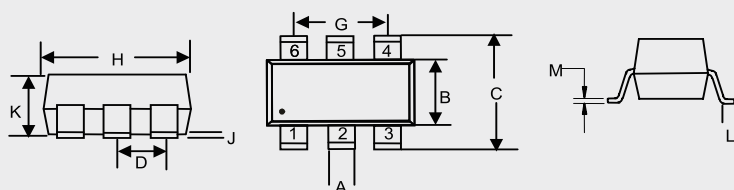

DIMENSIONS					
DIM	INCHES		MM		NOTE
	MIN	MAX	MIN	MAX	
A	0.012	0.020	0.30	0.50	
B	0.051	0.070	1.30	1.80	
C	0.087	0.126	2.20	3.20	
D	0.037		0.95		TYP.
G	0.074		1.90		TYP.
H	0.106	0.122	2.70	3.10	
J	0.002	0.006	0.05	0.15	
K	0.030	0.051	0.75	1.30	
L	0.012	0.024	0.30	0.60	
M	0.003	0.008	0.08	0.22	

SOT-323

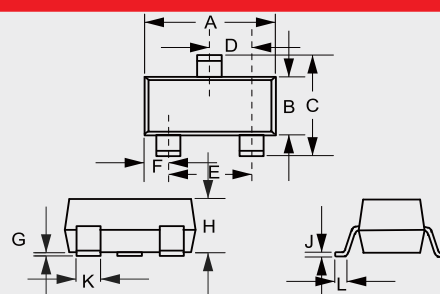
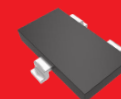

DIMENSIONS					
DIM	INCHES		MM		NOTE
	MIN	MAX	MIN	MAX	
A	0.071	0.087	1.80	2.20	
B	0.045	0.053	1.15	1.35	
C	0.083	0.096	2.10	2.45	
D	0.026		0.65		TYP.
E	0.047	0.055	1.20	1.40	
F	0.012	0.016	0.30	0.40	
G	0.000	0.004	0.00	0.10	
H	0.035	0.044	0.90	1.10	
J	0.002	0.010	0.05	0.25	
K	0.006	0.016	0.15	0.40	
L	0.010	0.018	0.26	0.46	

Package Outline

Package Outline

SOT-363

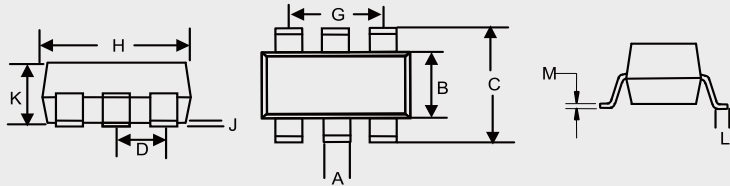
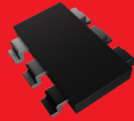

DIM	DIMENSIONS				NOTE
	INCHES		MM		
	MIN	MAX	MIN	MAX	
A	0.006	0.014	0.15	0.35	
B	0.045	0.053	1.15	1.35	
C	0.079	0.096	2.00	2.45	
D	0.026		0.65		TYP.
G	0.047	0.055	1.20	1.40	
H	0.071	0.087	1.80	2.20	
J	---	0.004	---	0.10	
K	0.031	0.043	0.80	1.10	
L	0.010	0.018	0.26	0.46	
M	0.003	0.006	0.08	0.15	

SOT-523

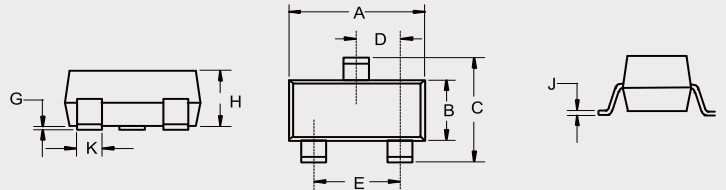
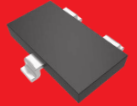

DIM	DIMENSIONS				NOTE
	INCHES		MM		
	MIN	MAX	MIN	MAX	
A	0.059	0.067	1.50	1.70	
B	0.030	0.033	0.75	0.85	
C	0.057	0.069	1.45	1.75	
D	0.020		0.50		TYP.
E	0.035	0.043	0.90	1.10	
G	0.000	0.004	0.00	0.10	
H	0.028	0.031	0.70	0.80	
J	0.004	0.008	0.10	0.20	
K	0.006	0.014	0.15	0.35	

SOT-563

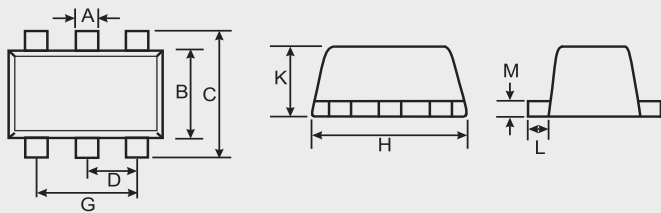
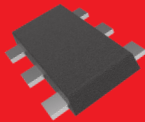

DIM	DIMENSIONS				NOTE
	INCHES		MM		
	MIN	MAX	MIN	MAX	
A	0.006	0.011	0.15	0.30	
B	0.043	0.051	1.10	1.30	
C	0.059	0.067	1.50	1.70	
D	0.020		0.50		TYP.
G	0.035	0.043	0.90	1.10	
H	0.059	0.067	1.50	1.70	
K	0.020	0.023	0.52	0.60	
L	0.004	0.011	0.10	0.30	
M	0.004	0.007	0.10	0.18	

SOT-723

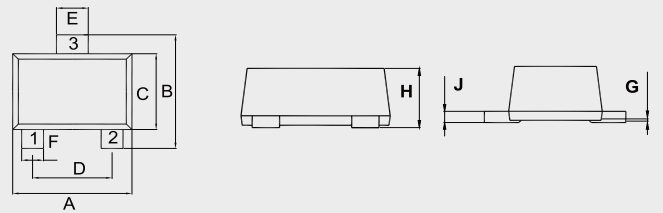
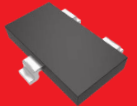

DIM	DIMENSIONS				NOTE
	INCHES		MM		
	MIN	MAX	MIN	MAX	
A	0.043	0.051	1.10	1.30	
B	0.043	0.051	1.10	1.30	
C	0.028	0.035	0.70	0.90	
D	0.031		0.80		TYP.
E	0.009	0.017	0.22	0.42	
F	0.005	0.013	0.12	0.32	
G	0.000	0.002	0.00	0.05	
H	0.017	0.021	0.43	0.54	
J	0.003	0.006	0.08	0.15	

Package Outline

SOT-89

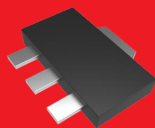

TO-277

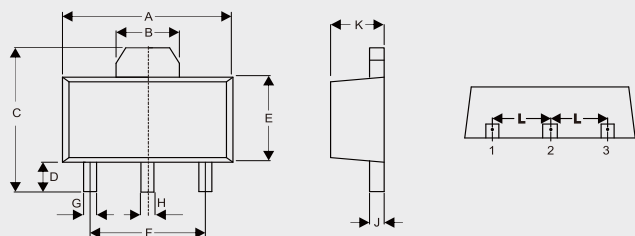
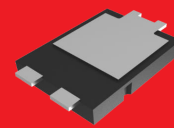

DIMENSIONS					
DIM	INCHES		MM		NOTE
	MIN	MAX	MIN	MAX	
A	0.169	0.185	4.30	4.70	
B	0.061		1.55		TYP.
C	0.154	0.171	3.91	4.35	
D	0.031	0.047	0.80	1.20	
E	0.089	0.104	2.25	2.65	
F	0.118		3.00		TYP.
G	0.013	0.020	0.33	0.52	
H	0.015	0.021	0.38	0.53	
J	0.014	0.017	0.35	0.44	
K	0.055	0.063	1.40	1.60	
L	0.059		1.50		TYP.

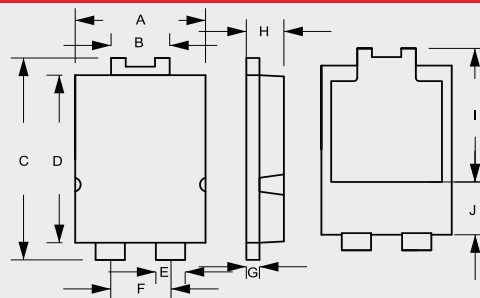

DIMENSIONS					
DIM	INCHES		MM		NOTE
	MIN	MAX	MIN	MAX	
A	0.154	0.161	3.90	4.10	
B	0.067	0.075	1.70	1.90	
C	0.252	0.260	6.40	6.60	
D	0.209	0.217	5.30	5.50	
E	0.031	0.039	0.80	1.00	
F	0.071	0.075	1.80	1.90	
G	0.014	0.018	0.35	0.45	
H	0.043	0.047	1.10	1.20	
I	0.161	0.177	4.10	4.50	
J	0.059	0.075	1.50	1.90	

SDB-1

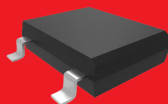

DB-1

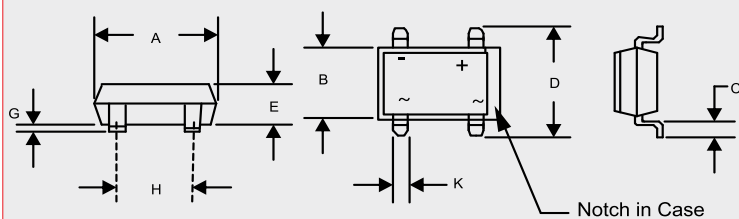
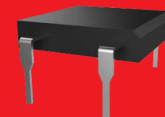

DIMENSIONS					
DIM	INCHES		MM		NOTE
	MIN	MAX	MIN	MAX	
A	0.316	0.335	8.05	8.51	
B	0.245	0.255	6.20	6.50	
C	0.040	0.060	1.02	1.50	
D	0.360	0.410	9.40	10.40	
E	0.102	0.130	2.60	3.30	
G	0.003	0.013	0.076	0.33	
H	0.195	0.205	5.00	5.20	
K	0.038	0.047	1.00	1.20	

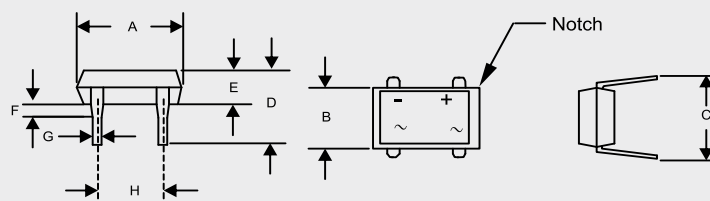

DIMENSIONS					
DIM	INCHES		MM		NOTE
	MIN	MAX	MIN	MAX	
A	0.316	0.335	8.05	8.51	
B	0.245	0.255	6.20	6.50	
C	0.300	0.350	7.60	8.90	
D	0.236	0.299	6.01	7.60	
E	0.102	0.130	2.60	3.30	
F	0.060		1.50		TYP.
G	0.016	0.022	0.41	0.56	TYP.
H	0.195	0.205	5.00	5.20	

Package Outline

Package Outline

DBL-1



SDBL-1

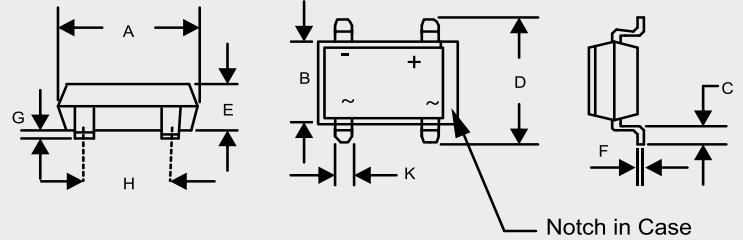
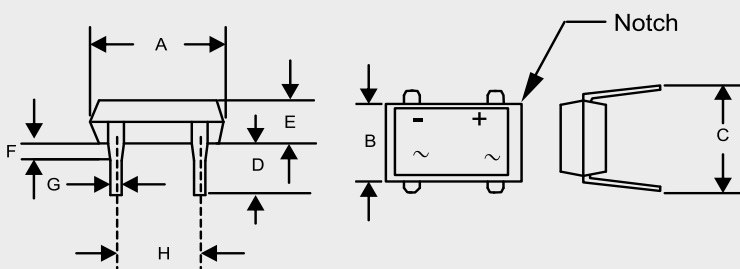
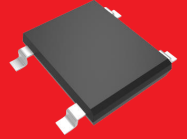

DIM	DIMENSIONS				NOTE
	INCHES		MM		
	MIN	MAX	MIN	MAX	
A	0.316	0.335	8.05	8.51	
B	0.245	0.255	6.20	6.50	
C	0.300	0.350	7.60	8.90	
D	0.150	0.185	3.81	4.69	
E	0.093	0.096	2.35	2.45	
F	0.050	0.080	1.27	2.03	
G	0.018	0.023	0.46	0.56	
H	0.195	0.205	5.00	5.20	

DIM	DIMENSIONS				NOTE
	INCHES		MM		
	MIN	MAX	MIN	MAX	
A	0.320	0.335	8.12	8.51	
B	0.244	0.256	6.20	6.50	
C	0.040	0.060	1.02	1.53	
D	0.366	0.413	9.30	10.50	
E	0.093	0.096	2.35	2.45	
F	0.006	0.013	0.15	0.33	
G	0.003	0.013	0.076	0.33	
H	0.195	0.205	5.00	5.20	
K	0.037	0.047	0.95	1.20	

LMBS-1

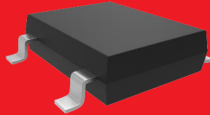

MBLS-1

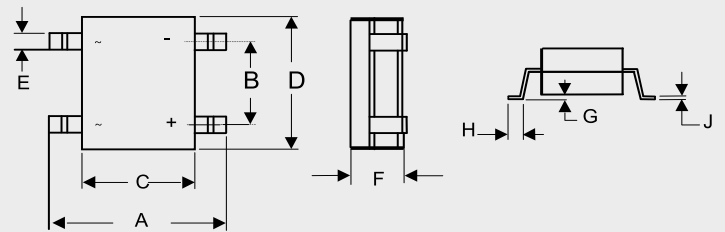
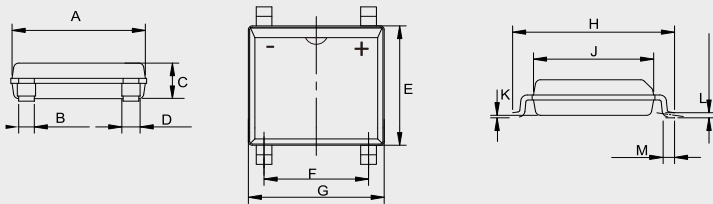
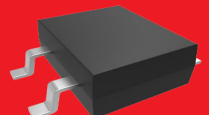

DIM	DIMENSIONS				NOTE
	INCHES		MM		
	MIN	MAX	MIN	MAX	
A	0.197	0.205	4.90	5.20	
B	0.024		0.60		
C	---	0.059	---	1.50	
D	0.024	0.032	0.60	0.80	
E	---	0.189	---	4.80	
F	0.150	0.165	3.80	4.20	
G	---	0.209	---	5.30	
H	0.236	0.252	6.00	6.60	
J	0.177	0.185	4.30	4.70	
K	0.0009	0.004	0.02	0.21	
L	0.006	0.012	0.15	0.30	
M	0.017	0.031	0.25	0.80	

DIM	DIMENSIONS				NOTE
	INCHES		MM		
	MIN	MAX	MIN	MAX	
A	0.252	0.283	6.40	7.20	
B	0.087	0.102	2.20	2.60	
C	0.142	0.193	3.60	4.90	
D	0.177	0.200	4.55	5.10	
E	0.022	0.033	0.55	0.84	
F	0.045	0.063	1.15	1.60	
G	0.000	0.008	0.00	0.20	
H	0.016	0.043	0.40	1.10	
J	0.004	0.016	0.10	0.35	

Package Outline

MBS-1

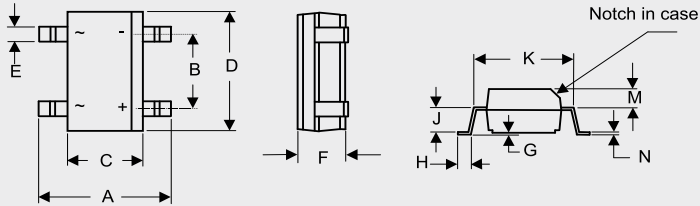

DIM	INCHES		MM		NOTE
	MIN	MAX	MIN	MAX	
A	0.252	0.276	6.40	7.00	
B	0.095	0.106	2.41	2.70	
C	0.142	0.165	3.60	4.20	
D	0.179	0.195	4.55	4.95	
E	0.019	0.031	0.50	0.80	
F	0.090	0.106	2.30	2.70	
G	0.002	0.008	0.05	0.20	
H	0.027	0.043	0.70	1.10	
J	0.058	0.062	1.47	1.57	
K	0.195	0.205	4.95	5.21	
M	0.039	0.049	0.99	1.24	
N	0.006	0.016	0.15	0.41	

TBL

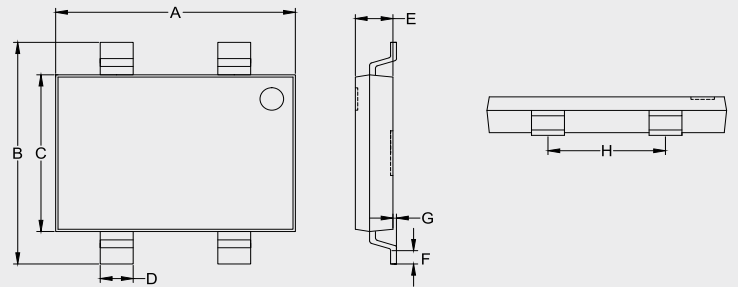
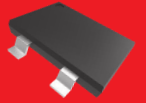

DIM	INCHES		MM		NOTE
	MIN	MAX	MIN	MAX	
A	0.394	0.409	10.00	10.40	
B	0.382	0.398	9.70	10.10	
C	0.268	0.283	6.80	7.20	
D	0.051	0.059	1.30	1.50	
E	0.055	0.071	1.40	1.80	
F	0.020	0.043	0.50	1.10	
G	0.000	0.006	0.00	0.15	
H	0.193	0.201	4.90	5.10	

TBS

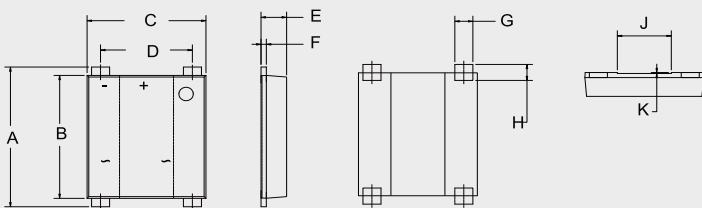

DIM	INCHES		MM		NOTE
	MIN	MAX	MIN	MAX	
A	0.311	0.339	7.90	8.60	
B	0.283	0.291	7.20	7.40	
C	0.256	0.264	6.50	6.70	
D	0.197	0.205	5.00	5.20	
E	0.051	0.059	1.30	1.50	
F	0.011	0.016	0.27	0.40	
G	0.037	0.045	0.95	1.15	
H	0.028	0.041	0.70	1.05	
J	0.114	0.122	2.90	3.10	
K	0.0015	0.003	0.04	0.08	

RS-4L

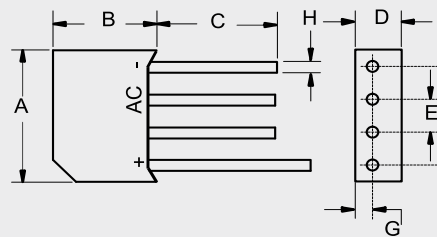
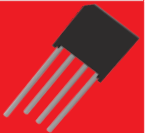

DIM	INCHES		MM		NOTE
	MIN	MAX	MIN	MAX	
A	0.728	0.768	18.50	19.50	
B	0.600	0.640	15.20	16.30	
C	0.630	---	16.00	---	
D	0.217	0.256	5.50	6.50	
E	0.180	0.220	4.60	5.60	
G	---	0.083	---	2.10	
H	0.048	0.052	1.20	1.30	

Package Outline

Package Outline

RS-6

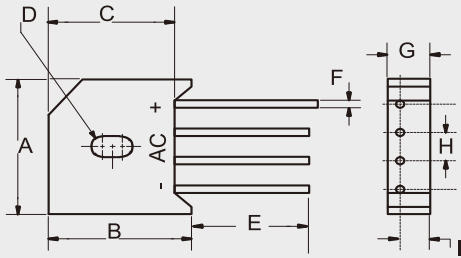

DIMENSIONS					NOTE
DIM	INCHES		MM		
	MIN	MAX	MIN	MAX	
A	0.895	0.935	22.70	23.70	
B	---	0.760	---	19.30	
C	0.660	0.728	16.80	18.50	
D	0.15 ϕ X 0.23L		3.8 ϕ X 5.57L		HOLE
E	0.787	---	20.00	---	
F	0.048	0.052	1.20	1.30	
G	0.260	0.280	6.60	7.10	
H	0.180	0.220	4.60	5.60	
I	0.181	0.205	4.60	5.20	

D3K

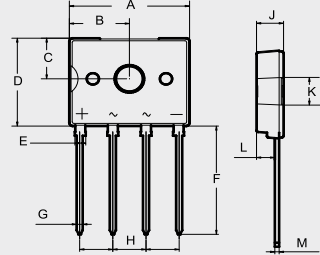
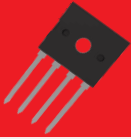

DIMENSIONS					
DIM	INCHES		MM		NOTE
	MIN	MAX	MIN	MAX	
A	0.524	0.563	13.30	14.30	
B	0.252	0.291	6.40	7.40	
C	0.177	0.217	4.50	5.50	
D	0.406	0.445	10.30	11.30	
E	0.041	0.057	1.05	1.45	
F	0.516	0.531	13.10	13.50	
G	0.024	0.033	0.60	0.85	
H	0.146	0.154	3.70	3.90	
J	0.102	0.142	2.60	3.60	
K	0.122	0.134	3.10	3.40	
L	0.079	0.087	2.00	2.20	
M	0.016	0.024	0.40	0.60	

JA

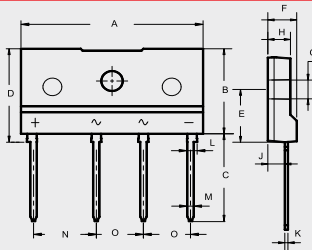

DIMENSIONS					NOTE
DIM	INCHES		MM		
	MIN	MAX	MIN	MAX	
A	1.130	1.154	28.70	29.30	
B	0.559	0.583	14.20	14.80	
C	0.575	0.598	14.60	15.20	
D	0.614	0.638	15.60	16.20	
E	0.343	0.366	8.70	9.30	
F	0.169	0.193	4.30	4.90	
G	0.122	0.134	3.10	3.40	
H	0.130	0.154	3.30	3.90	
J	0.098	0.114	2.50	2.90	
K	0.012	0.024	0.40	0.60	
L	0.059	0.067	1.50	1.70	
M	0.035	0.043	0.90	1.10	
N	0.390	0.400	9.80	10.20	
O	0.290	0.300	7.30	7.70	

JB

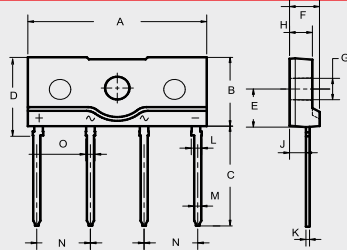

DIMENSIONS					
DIM	INCHES		MM		NOTE
	MIN	MAX	MIN	MAX	
A	0.972	0.996	24.70	25.30	
B	0.394	0.417	10.00	10.60	
C	0.575	0.598	14.60	15.20	
D	0.449	0.472	11.40	12.00	
E	0.213	0.236	5.40	6.00	
F	0.154	0.177	3.90	4.50	
G	0.122	0.134	3.10	3.40	
H	0.114	0.138	2.90	3.90	
J	0.079	0.102	2.00	2.60	
K	0.012	0.024	0.40	0.60	
L	0.053	0.061	1.35	1.55	
M	0.035	0.043	0.90	1.10	
N	0.287	0.303	7.30	7.70	
O	0.047	0.055	1.20	1.40	

Package Outline

GBJ

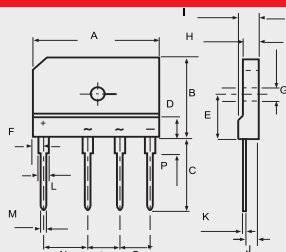

DIM	DIMENSIONS				NOTE
	INCHES		MM		
	MIN	MAX	MIN	MAX	
A	1.170	1.190	29.70	30.30	
B	0.780	0.800	19.70	20.30	
C	0.670	0.710	17.00	18.00	
D	0.190	0.190	4.70	4.90	
E	0.430	0.440	10.80	11.20	
F	0.090	0.110	2.30	2.70	
G	0.120	0.130	3.10	3.40	
H	0.130	0.150	3.40	3.80	
R	0.170	0.190	4.40	4.80	
J	0.100	0.110	2.50	2.90	
K	0.020	0.030	0.60	0.80	
L	0.080	0.090	2.00	2.40	
M	0.040	0.040	0.90	1.10	
N	0.390	0.400	9.80	10.20	
O	0.290	0.300	7.30	7.70	
P	0.150	0.170	3.80	4.20	

GBL

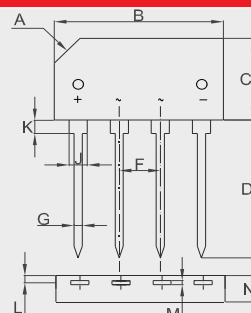
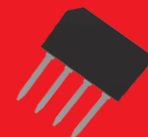

DIM	DIMENSIONS				NOTE
	INCHES		MM		
	MIN	MAX	MIN	MAX	
A	0.118 X 0.118		3.0 X 3.0		X 45°
B	0.756	0.835	19.20	21.20	
C	0.413	0.453	10.50	11.50	
D	0.512	0.591	13.00	15.00	
F	0.193	0.201	4.90	5.10	
G	0.039	0.047	1.00	1.20	
J	0.047	0.071	1.20	1.80	
K	0.079	0.118	2.00	3.00	
L	0.035	0.043	0.90	1.10	
M	0.020	0.027	0.50	0.70	
N	0.118	0.157	3.00	4.00	

GBP

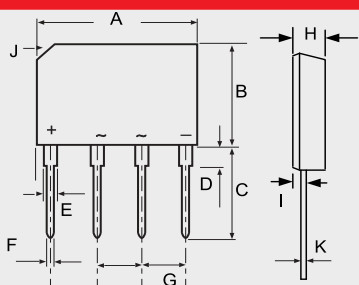
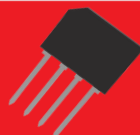

DIM	DIMENSIONS				NOTE
	INCHES		MM		
	MIN	MAX	MIN	MAX	
A	0.561	0.580	14.25	14.75	
B	0.406	0.417	10.10	10.60	
C	0.561	0.581	14.25	14.73	
D	0.071	0.087	1.80	2.20	
E	0.046	0.056	1.17	1.42	
F	0.030	0.034	0.76	0.86	
G	0.140	0.160	3.56	4.06	
H	0.131	0.161	3.35	4.10	
I	0.031	0.043	0.80	1.10	
J	0.106 X 45°		2.70 X 45°		
K	0.012	0.025	0.30	0.64	

KBJ

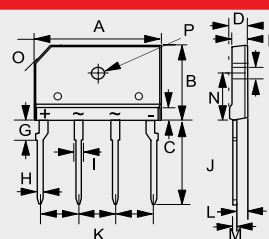
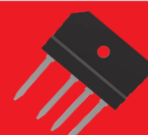

DIM	DIMENSIONS				NOTE
	INCHES		MM		
	MIN	MAX	MIN	MAX	
A	0.976	0.992	24.80	25.20	
B	0.579	0.602	14.70	15.30	
C	0.154	0.161	3.90	4.10	
D	0.173	0.189	4.40	4.80	
E	0.134	0.150	3.40	3.80	
F	0.122	0.134	3.10	3.40	Φ
G	0.130	0.146	3.30	3.70	
H	0.035	0.043	0.90	1.10	
I	0.059	0.075	1.50	1.90	
J	0.669	0.709	17.00	18.00	
K	0.287	0.303	7.30	7.70	
L	0.098	0.114	2.50	2.90	
M	0.024	0.031	0.60	0.80	
N	0.366	0.413	9.30	10.50	
O	0.118 X 45°		3.0 X 45°		
P	0.122	0.134	3.10	3.40	Φ

Package Outline

Package Outline

GBU  **TSB-5** 

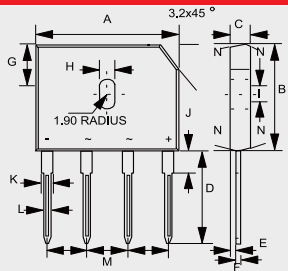

DIM	DIMENSIONS				NOTE
	INCHES		MM		
	MIN	MAX	MIN	MAX	
A	0.860	0.880	21.80	22.30	
B	0.720	0.740	18.30	18.80	
C	0.130	0.142	3.30	3.60	
D	0.690	0.717	17.50	18.20	
E	0.030	0.039	0.76	1.00	
F	0.018	0.024	0.46	0.60	
G	0.290	0.310	7.40	7.90	
H	0.140	0.160	3.50	4.10	
I	0.065	0.085	1.65	2.16	
J	0.060	0.096	1.52	2.45	
K	0.077	0.098	1.95	2.50	
L	0.040	0.050	1.02	1.27	
M	0.190	0.210	4.83	5.33	
N	7.0°				TYP.

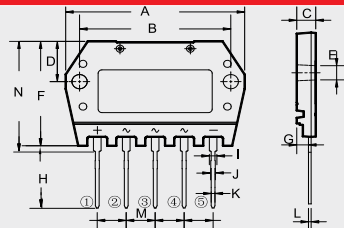

DIM	DIMENSIONS				NOTE
	INCHES		MM		
	MIN	MAX	MIN	MAX	
A	1.834	1.874	46.60	47.60	
B	1.555	1.579	39.50	40.10	
C	0.185	0.209	4.70	5.30	
D	0.433	0.457	11.00	11.60	
E	0.157	0.177	4.00	4.50	
F	1.134	1.173	28.80	29.80	
G	0.118	0.126	3.00	3.20	
H	0.677	0.701	17.20	17.80	
I	0.075	0.083	1.90	2.10	
J	0.039	0.047	1.00	1.20	
K	0.035	0.043	0.90	1.10	
L	0.024	0.031	0.60	0.80	
M	0.296	0.304	7.52	7.72	
N	1.193	1.232	30.30	31.30	

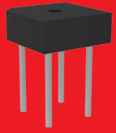
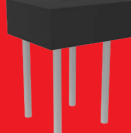
PB-6  **PB-10** 

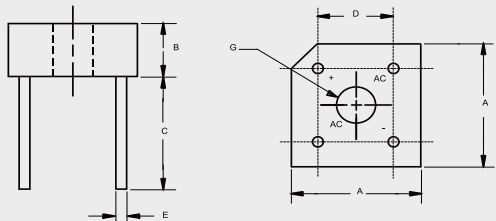

DIM	DIMENSIONS				NOTE
	INCHES		MM		
	MIN	MAX	MIN	MAX	
A	0.578	0.619	14.69	15.71	2PL
B	0.230	0.270	5.84	6.86	
C	0.752	—	19.10	—	
D	0.405	0.445	10.29	11.31	2PL
E	0.038	0.042	0.97	1.07	4PL/TY
G	0.145	—	3.70	—	Φ

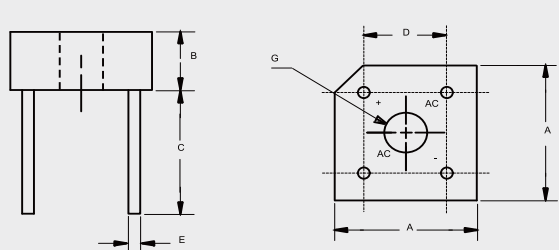

DIM	DIMENSIONS				NOTE
	INCHES		MM		
	MIN	MAX	MIN	MAX	
A	0.730	0.770	18.50	19.56	2PL
B	0.250	0.300	6.35	7.60	
C	0.750	—	19.10	—	
D	0.480	0.520	12.20	13.20	2PL
E	0.050		1.27		4PL/TYP
G	HOLE FOR NO 6 SCREW				Φ

Package Outline

PB

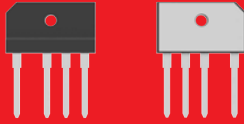

GBPC

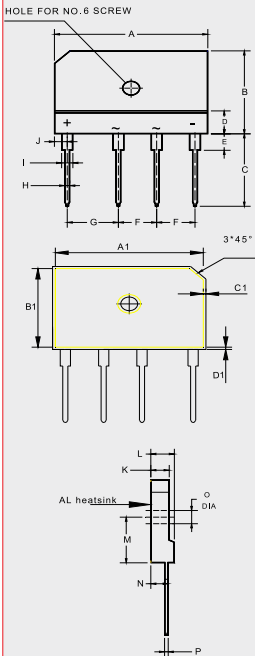
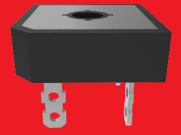

DIM	DIMENSIONS				NOTE
	INCHES		MM		
	MIN	MAX	MIN	MAX	
A	1.169	1.193	29.70	30.30	
B	0.776	0.799	19.70	20.30	
C	0.669	0.709	17.00	18.00	
D	0.189	0.228	4.80	5.80	
E	0.150	0.165	3.80	4.20	
F	0.287	0.303	7.30	7.70	
G	0.386	0.402	9.80	10.20	
H	0.035	0.043	0.90	1.10	
I	0.079	0.094	2.00	2.40	
J	0.091	0.106	2.30	2.70	
K	0.134	0.150	3.40	3.80	
L	0.173	0.189	4.40	4.80	
M	0.425	0.441	10.80	11.20	
N	0.122	0.146	3.10	3.70	
O	0.122	0.134	3.10	3.40	
P	0.024	0.031	0.60	0.80	
A1	1.136	1.144	28.85	29.05	
B1	0.742	0.750	18.85	19.05	
C1	0.016	0.024	0.40	0.60	
D1	0.016	0.024	0.40	0.60	

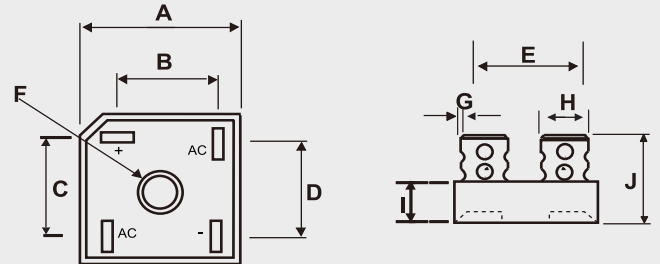

DIM	DIMENSIONS				NOTE
	INCHES		MM		
	MIN	MAX	MIN	MAX	
A	1.114	1.134	28.30	28.80	
B	0.634	0.673	16.10	17.10	
C	0.634	0.673	16.10	17.10	
D	0.543	0.583	13.80	14.80	
E	0.693	0.732	17.60	18.60	
F	0.197		5.00		Φ(Nom.)
G	0.030	0.034	0.76	0.86	
H	0.244	0.256	6.20	6.50	
I	0.291	0.335	7.40	8.50	
J	0.740	0.850	18.80	21.60	

GBPC-H

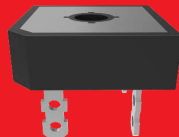

GBPC-W

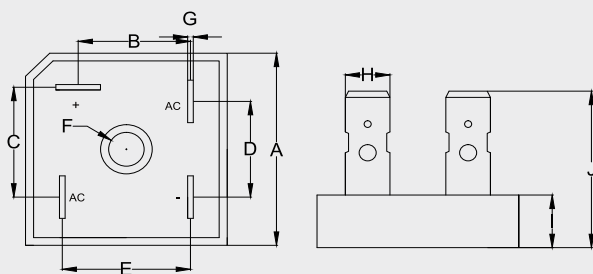
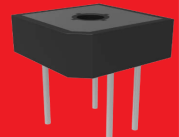

DIM	DIMENSIONS				NOTE
	INCHES		MM		
	MIN	MAX	MIN	MAX	
A	1.114	1.134	28.30	28.80	
B	0.634	0.673	16.10	17.10	
C	0.634	0.673	16.10	17.10	
D	0.543	0.583	13.80	14.80	
E	0.693	0.732	17.60	18.60	
F	0.197		5.00		Φ(Nom.)
G	0.030	0.034	0.76	0.86	
H	0.244	0.256	6.20	6.50	
I	0.291	0.335	7.40	8.50	
J	0.874	0.953	22.20	24.20	

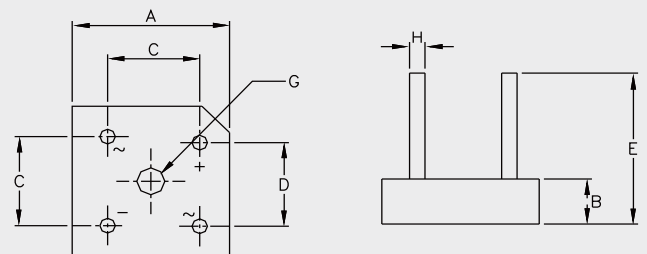

DIM	DIMENSIONS				NOTE
	INCHES		MM		
	MIN	MAX	MIN	MAX	
A	1.110	1.142	28.20	29.00	
B	0.425	0.445	10.80	11.30	
C	0.673	0.752	17.10	19.10	
D	0.410	0.490	10.40	12.40	
E	1.180	---	30.00	---	
H	0.038	0.042	0.97	1.07	
G	0.200	0.220	5.08	5.59	

Package Outline

Package Outline

MT-35A

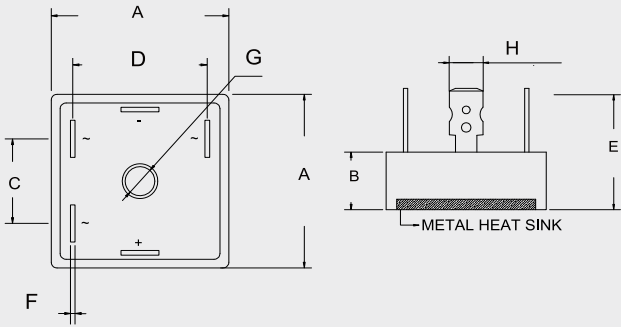
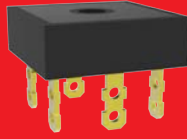

DIM	INCHES		MM		NOTE
	MIN	MAX	MIN	MAX	
A	1.110	1.134	28.20	28.80	
B	0.354	0.394	9.00	10.00	
C	0.610	0.650	15.50	16.50	
D	0.917	0.957	23.30	24.30	
E	0.944		25.00		TYP.
F	0.029	0.033	0.75	0.85	
G	0.193		4.90		TYP.
H	0.244	0.251	6.20	6.40	

MB-35

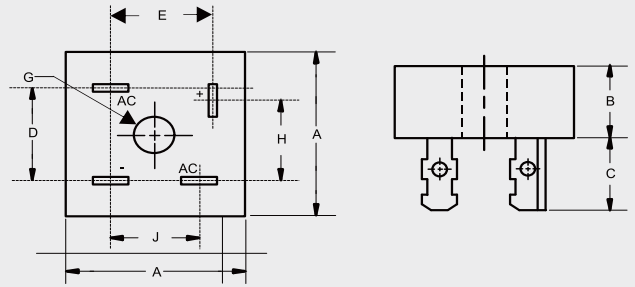
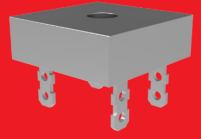

DIM	INCHES		MM		NOTE
	MIN	MAX	MIN	MAX	
A	1.110	1.135	28.20	28.83	
B	0.425	0.447	10.80	11.35	
C	0.421	0.480	10.70	12.20	
D	0.673	0.751	17.10	19.10	
E	0.602	0.681	15.30	17.30	
G	0.193	---	4.90	---	Φ
H	0.602	0.681	15.30	17.30	
J	0.519	0.598	13.20	15.20	

MB-35W

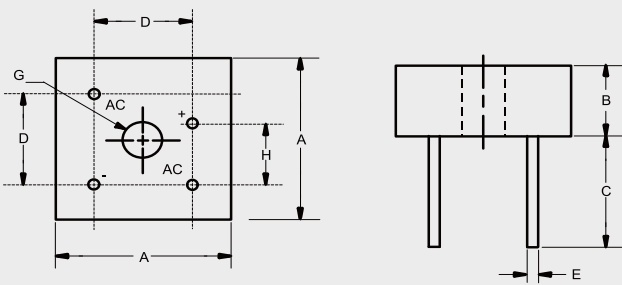
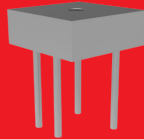

DIM	INCHES		MM		NOTE
	MIN	MAX	MIN	MAX	
A	1.115	1.135	28.33	28.83	
B	0.427	0.447	10.85	11.35	
C	0.774	---	19.65	---	
D	0.673	0.752	17.10	19.10	
E	0.038	0.042	0.96	1.07	4PL/TYP
G	0.193	---	4.90	---	Φ
H	0.429	0.469	10.90	11.90	

MP-50

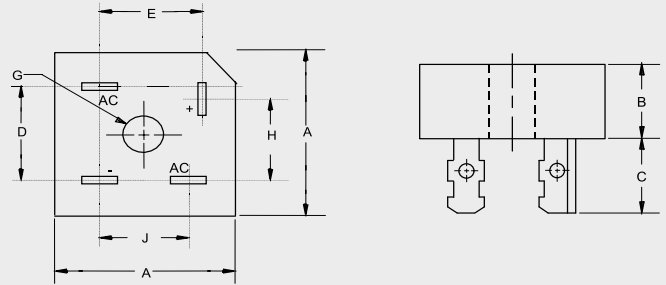
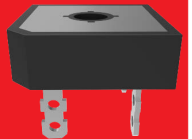

DIM	INCHES		MM		NOTE
	MIN	MAX	MIN	MAX	
A	1.110	1.140	28.20	29.00	
B	0.425	0.442	10.80	11.23	
C	0.468	0.558	11.89	14.17	
D	0.689	0.728	17.50	18.50	
E	0.618	0.657	15.70	16.70	
G	0.193	---	4.90	---	Φ
H	0.618	0.657	15.70	16.70	
J	0.531	0.571	13.50	14.50	

Package Outline

MP-50W

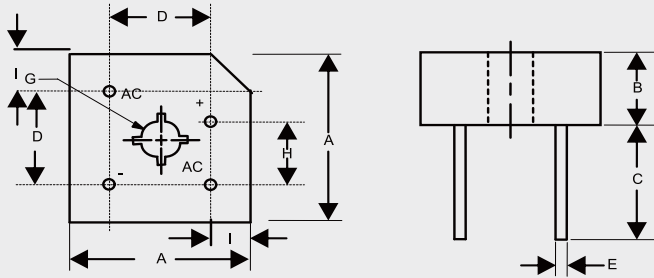
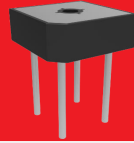

DIMENSIONS					
DIM	INCHES		MM		NOTE
	MIN	MAX	MIN	MAX	
A	1.118	1.130	28.40	28.70	
B	0.432	0.442	10.97	11.23	
C	0.769	—	19.53	—	
D	0.673	0.752	17.10	19.10	
E	0.038	0.042	0.97	1.07	4PL/TYP
G	0.193	—	4.90	—	Φ
H	0.429	0.468	10.90	11.90	
I	0.169	0.236	4.30	6.00	

AK

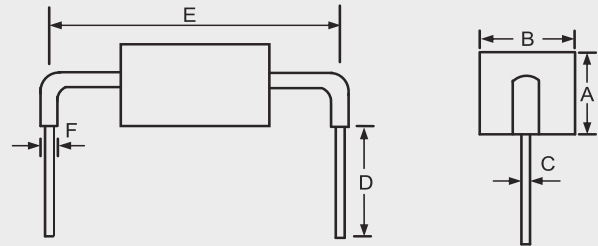
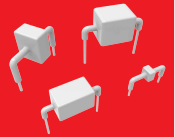

DIMENSIONS					
DIM	INCHES		MM		NOTE
	MIN	MAX	MIN	MAX	
A	—	0.630	—	16.00	
B	—	0.709	—	18.00	
C	0.047	0.052	1.20	1.32	
D	0.197	—	5.00	—	
E	0.922	0.979	23.43	24.87	
F	—	0.157	—	4.00	

TO-220

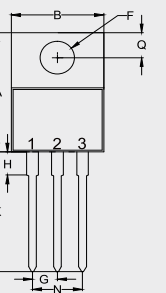
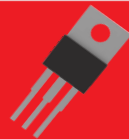

DIMENSIONS					
DIM	INCHES		MM		NOTE
	MIN	MAX	MIN	MAX	
A	0.560	0.625	14.22	15.88	
B	0.380	0.420	9.65	10.67	
C	0.140	0.190	3.56	4.82	
D	0.020	0.045	0.51	1.14	
F	0.139	0.161	3.53	4.09	Φ
G	0.090	0.110	2.29	2.79	
H	—	0.250	—	6.35	
J	0.012	0.025	0.30	0.64	
K	0.500	0.580	12.70	14.73	
L	0.045	0.060	1.14	1.52	
N	0.190	0.210	4.83	5.33	
Q	0.100	0.135	2.54	3.43	
R	0.080	0.115	2.04	2.92	
S	0.045	0.055	1.14	1.39	
T	0.230	0.270	5.84	6.86	
U	—	0.050	—	1.27	
V	0.045	—	1.15	—	

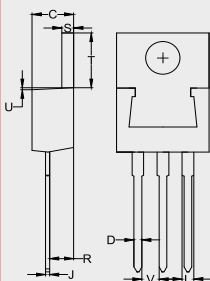

TO-220AB

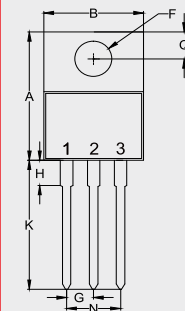
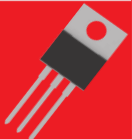

DIMENSIONS					
DIM	INCHES		MM		NOTE
	MIN	MAX	MIN	MAX	
A	0.560	0.625	14.22	15.88	
B	0.380	0.429	9.65	10.90	
C	0.140	0.201	3.56	5.10	
D	0.020	0.045	0.51	1.14	
F	0.131	0.170	3.34	4.31	Φ
G	0.079	0.121	2.01	3.07	
H	—	0.250	—	6.35	
J	0.011	0.025	0.28	0.64	
K	0.500	0.580	12.70	14.73	
L	0.045	0.060	1.14	1.52	
N	0.158	0.242	4.02	6.14	
Q	0.087	0.135	2.22	3.43	
R	0.080	0.126	2.04	3.19	
S	0.045	0.055	1.14	1.39	
T	0.230	0.270	5.84	6.86	
U	—	0.050	—	1.27	
V	0.045	—	1.15	—	

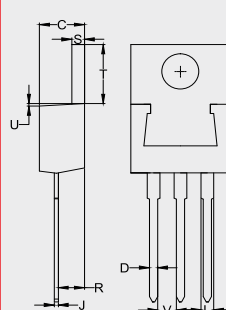

Package Outline

Package Outline

TO-220AB(H)

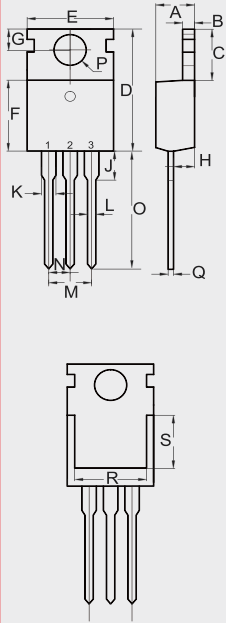
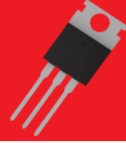

DIM	INCHES		MM		NOTE
	MIN	MAX	MIN	MAX	
A	0.172	0.188	4.37	4.77	
B	0.049	0.057	1.25	1.45	
C	0.246	0.270	6.25	6.85	
D	0.594	0.634	15.10	16.10	
E	0.382	0.406	9.70	10.30	
F	0.346	0.370	8.80	9.40	
G	0.102	0.118	2.60	3.00	
H	0.087	0.102	2.20	2.60	
J	-----	0.134	-----	3.40	
K	0.046	0.058	1.17	1.47	
L	0.028	0.037	0.70	0.95	
M	0.200 BSC		5.08 BSC		
N	0.100 BSC		2.54 BSC		
O	0.502	0.543	12.75	13.80	
P	0.134	0.150	3.40	3.80	Φ
Q	0.016	0.026	0.40	0.65	
R	0.276	-----	7.00	-----	
S	0.217	-----	5.50	-----	

TO-220AC

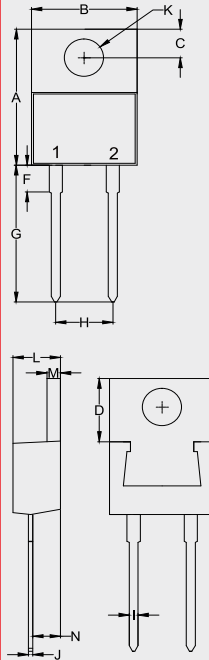

DIM	INCHES		MM		NOTE
	MIN	MAX	MIN	MAX	
A	0.560	0.625	14.22	15.88	
B	0.380	0.420	9.65	10.67	
C	0.100	0.135	2.54	3.43	
D	0.230	0.270	5.84	6.86	
F	-----	0.250	-----	6.35	
G	0.500	0.580	12.70	14.73	
H	0.190	0.210	4.83	5.33	
I	0.020	0.045	0.51	1.14	
J	0.012	0.025	0.30	0.64	
K	0.139	0.161	3.53	4.09	Φ
L	0.140	0.190	3.56	4.83	
M	0.045	0.055	1.14	1.40	
N	0.080	0.115	2.03	2.92	

TO-220F

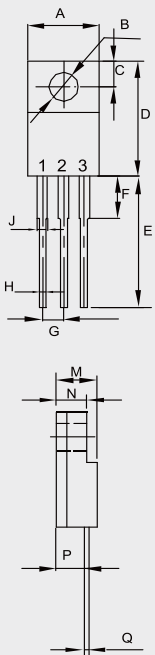
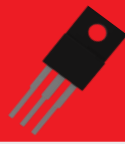

DIM	INCHES		MM		NOTE
	MIN	MAX	MIN	MAX	
A	0.392	0.421	9.96	10.70	
B	0.138		3.50		Φ
C	0.106		2.70		TYP.
D	0.567	0.642	14.40	16.30	
E	0.520		13.20		TYP.
F	---	0.177	---	4.50	
G	0.100		2.54		TYP.
H	0.020	0.035	0.50	0.90	
J	0.043	0.053	1.10	1.35	
M	0.169	0.201	4.30	5.10	
N	---	0.140	---	3.56	
P	0.083	0.126	2.10	3.20	
Q	0.020	0.032	0.50	0.80	

ITO-220AB

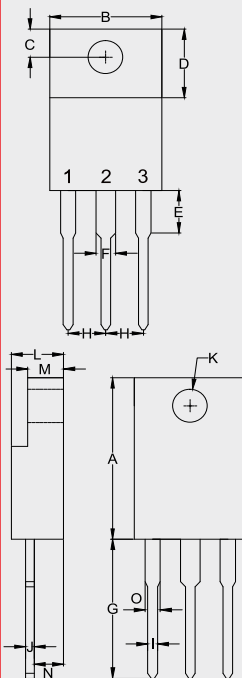
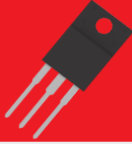

DIM	INCHES		MM		NOTE
	MIN	MAX	MIN	MAX	
A	0.567	0.642	14.40	16.30	
B	-----	0.421	-----	10.70	
C	0.085	0.128	2.15	3.25	
D	0.248	0.272	6.30	6.90	
E	-----	0.177	-----	4.50	
F	-----	0.071	-----	1.80	
G	0.500	0.539	12.70	14.20	
H	0.100		2.55		
I	-----	0.035	-----	0.90	
J	-----	0.032	-----	0.80	
K	0.102	0.150	2.60	3.80	Φ
L	-----	0.201	-----	5.10	
M	-----	0.140	-----	3.56	
N	0.083	0.126	2.10	3.20	
O	-----	0.071	-----	1.80	

Package Outline

ITO-220AC

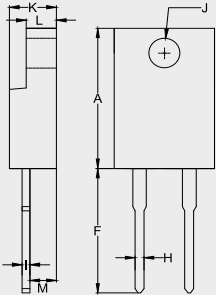
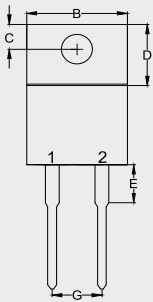

DIM	INCHES		MM		NOTE
	MIN	MAX	MIN	MAX	
A	0.567	0.606	14.40	15.40	
B	—	0.406	—	10.30	
C	0.100	0.112	2.55	2.85	
D	0.248	0.272	6.30	6.90	
E	—	0.161	—	4.10	
F	0.500	0.543	12.70	13.80	
G	0.200		5.10		
H	—	0.035	—	0.90	
I	—	0.032	—	0.80	
J	0.102	0.134	2.60	3.40	Φ
K	—	0.189	—	4.80	
L	—	0.123	—	3.10	
M	0.098	0.114	2.50	2.90	

TO-247

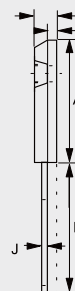
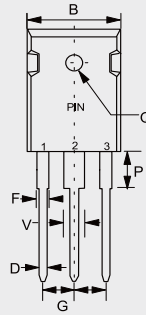
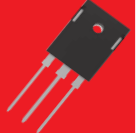

DIM	INCHES		MM		NOTE
	MIN	MAX	MIN	MAX	
A	0.787	0.866	20.00	22.00	
B	0.598	0.638	15.20	16.20	
C	0.185	0.208	4.70	5.30	
D	0.035	0.059	0.90	1.50	
E	0.059	0.094	1.50	2.40	
F	0.067	0.091	1.70	2.30	
J	0.019	0.031	0.48	0.80	
K	0.748	0.833	19.00	21.15	
P	0.122	0.189	3.10	4.80	
Q	0.118	0.150	3.00	3.80	Φ
V	0.106	0.134	2.70	3.40	
G	0.197	0.224	5.00	5.70	

TO-247-2L

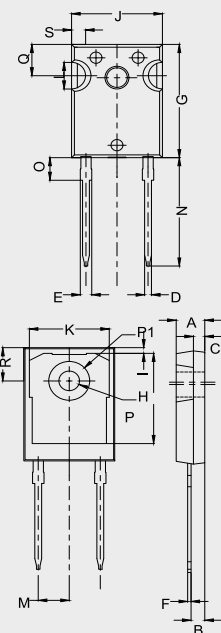
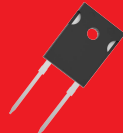

DIM	INCHES		MM		NOTE
	MIN	MAX	MIN	MAX	
A	0.190	0.205	4.83	5.21	
B	0.090	0.100	2.29	2.55	
C	0.059	0.098	1.50	2.49	
D	0.044	0.052	1.12	1.33	
E	0.075	0.094	1.91	2.39	
F	0.022	0.027	0.55	0.69	
G	0.819	0.831	20.80	21.10	
H	0.640	0.695	16.25	17.65	
I	0.020	0.053	0.51	1.35	
J	0.620	0.635	15.75	16.13	
K	0.530	0.557	13.46	14.16	
L	0.170	0.216	4.32	5.49	
M	0.214		5.44		TYP
N	0.780	0.800	19.81	20.32	
O	0.161	0.173	4.10	4.40	
P	0.140	0.144	3.56	3.65	Φ
P1	0.283		7.19		Φ
Q	0.212	0.244	5.39	6.20	
R	0.238	0.248	6.04	6.30	
S	0.085	0.108	2.16	2.75	

TO-247AC

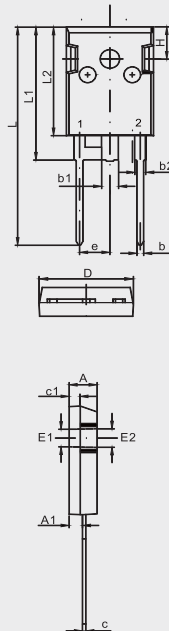
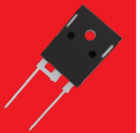

DIM	INCHES		MM		NOTE
	MIN	MAX	MIN	MAX	
A	0.185	0.209	4.70	5.30	
A1	0.087	0.102	2.20	2.60	
b	0.035	0.059	0.90	1.50	
b1	0.110	0.126	2.80	3.20	
b2	0.067	0.090	1.70	2.30	
c	0.020	0.028	0.50	0.70	
c1	0.071	0.087	1.80	2.20	
D	0.602	0.626	15.30	15.90	
E1	0.138		3.500		REF.
E2	0.142		3.600		REF.
L	1.583	1.646	40.20	41.80	
L1	0.976	0.988	24.80	25.10	
L2	0.799	0.811	20.30	20.60	
e	0.215		5.450		TYP.
H	0.236		6.000		REF.

Package Outline

Package Outline

TO-247AD

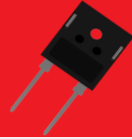

A-405

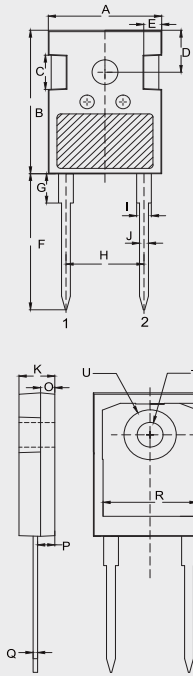

DIMENSIONS					
DIM	INCHES		MM		NOTE
	MIN	MAX	MIN	MAX	
A	0.610	0.663	15.50	16.85	
B	0.815	0.839	20.70	21.30	
C	0.189	0.205	4.80	5.20	
D	0.242		6.15		BSC.
E	0.091	0.106	2.30	2.70	
F	0.772	0.796	19.62	20.22	
G	---	0.169	---	4.30	
H	0.428		10.88		BSC.
I	0.075	0.087	1.91	2.21	
J	0.044	0.054	1.11	1.36	
K	0.189	0.205	4.80	5.20	
O	0.073	0.085	1.85	2.15	
P	0.087	0.103	2.21	2.61	
Q	0.020	0.030	0.51	0.75	
R	0.512	0.535	13.00	13.60	
S	0.640	0.663	16.25	16.85	
T	0.134	0.150	3.40	3.80	Φ
U	---	0.287	---	7.30	Φ

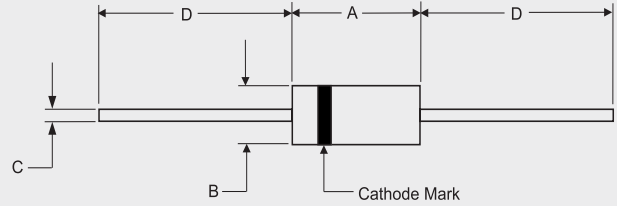

DIMENSIONS					
DIM	INCHES		MM		NOTE
	MIN	MAX	MIN	MAX	
A	0.166	0.205	4.10	5.20	
B	0.080	0.107	2.00	2.70	
C	---	0.024	---	0.60	
D	1.000	---	25.40	---	

DO-15



DO-201AD

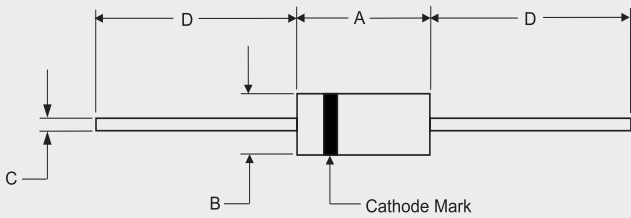
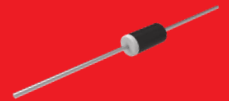

DIMENSIONS					
DIM	INCHES		MM		NOTE
	MIN	MAX	MIN	MAX	
A	0.230	0.300	5.80	7.60	
B	0.104	0.140	2.60	3.60	
C	0.026	0.034	0.70	0.90	
D	1.000	---	25.40	---	

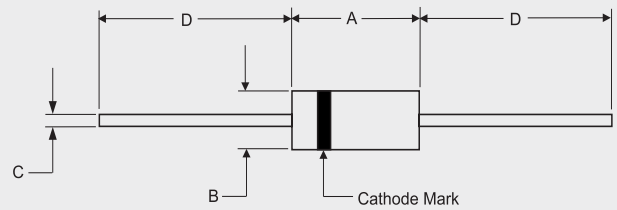

DIMENSIONS					
DIM	INCHES		MM		NOTE
	MIN	MAX	MIN	MAX	
A	0.287	0.374	7.30	9.50	
B	0.189	0.208	4.80	5.30	
C	0.048	0.052	1.20	1.30	
D	1.000	---	25.40	---	

Package Outline

DO-201AE



DO-41

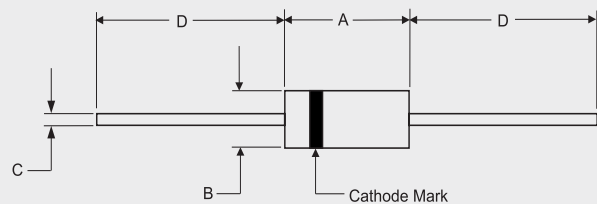
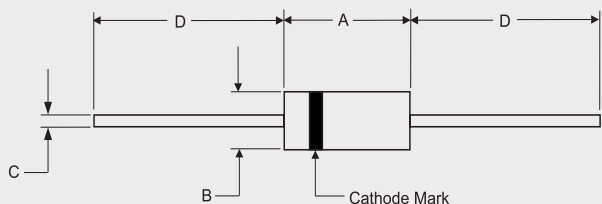

DIMENSIONS					
DIM	INCHES		MM		NOTE
	MIN	MAX	MIN	MAX	
A	---	0.370	---	9.50	
B	---	0.209	---	5.30	
C	0.038	0.042	0.96	1.06	
D	1.000	---	25.40	---	

DIMENSIONS					
DIM	INCHES		MM		NOTE
	MIN	MAX	MIN	MAX	
A	0.160	0.205	4.10	5.20	
B	0.080	0.107	2.00	2.70	Diameter
C	0.028	0.034	0.71	0.86	Diameter
D	1.000	---	25.40	---	

R-3



R-6

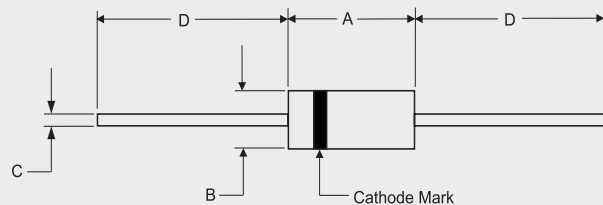
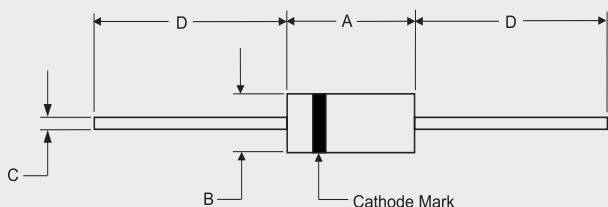
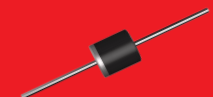

DIMENSIONS					
DIM	INCHES		MM		NOTE
	MIN	MAX	MIN	MAX	
A	---	0.160	---	4.10	
B	---	0.160	---	4.10	
C	0.040	0.042	1.01	1.07	
D	1.000	---	25.40	---	

DIMENSIONS					
DIM	INCHES		MM		NOTE
	MIN	MAX	MIN	MAX	
A	0.340	0.360	8.60	9.10	
B	0.340	0.360	8.60	9.10	
C	0.048	0.052	1.20	1.30	
D	1.000	---	25.40	---	