

MM74HCT04 Hex Inverter

General Description

The MM74HCT04 is a logic function fabricated by using advanced silicon-gate CMOS technology which provides the inherent benefits of CMOS - low quiescent power and wide power supply range. This device is input and output characteristic as well as pin-out compatible with standard 74LS logic families. The MM74HCT04, triple buffered, hex inverters, features low power dissipation and fast switching times. All inputs are protected from static discharge by internal diodes to V_{CC} and ground.

MM74HCT devices are intended to interface between TTL and NMOS components and standard CMOS devices.

These parts are also plug-in replacements for LS-TTL devices and can be used to reduce power consumption in existing designs.

Features

- TTL, LS pin-out and threshold compatible
- Fast switching: t_{PLH} , t_{PHL} = 12 ns (typ)
- Low power: 10 μ W at DC, 3.7 mW at 5 MHz
- High fanout: ≥ 10 LS loads
- Inverting, triple buffered

Ordering Code:

Order Number	Package Number	Package Description
MM74HCT04M	M14A	14-Lead Small Outline Integrated Circuit (SOIC), JEDEC MS-120, 0.150" Narrow
MM74HCT04SJ	M14D	14-Lead Small Outline Package (SOP), EIAJ TYPE II, 5.3mm Wide
MM74HCT04MTC	MTC14	14-Lead Thin Shrink Small Outline Package (TSSOP), JEDEC MO-153, 4.4mm Wide
MM74HCT04N	N14A	14-Lead Plastic Dual-In-Line Package (PDIP), JEDEC MS-001, 0.300" Wide

Devices also available in Tape and Reel. Specify by appending the suffix letter "X" to the ordering code.

Connection Diagram

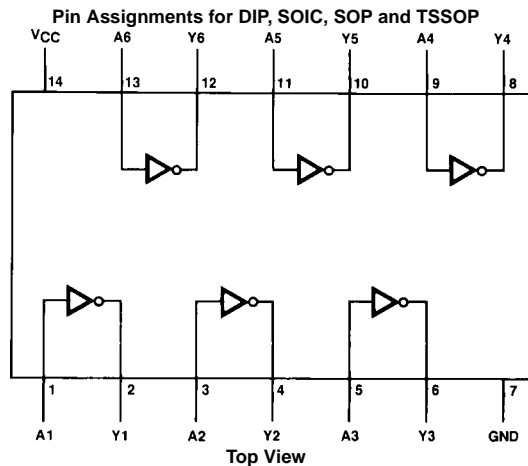

Absolute Maximum Ratings (Note 1)

(Note 2)

Supply Voltage (V_{CC})	-0.5 to +7.0V
DC Input Voltage (V_{IN})	-1.5 to $V_{CC} + 1.5V$
DC Output Voltage (V_{OUT})	-0.5 to $V_{CC} + 0.5V$
Clamp Diode Current (I_{IK}, I_{OK})	± 20 mA
DC Output Current, per pin (I_{OUT})	± 25 mA
DC V_{CC} or GND Current, per pin (I_{CC})	± 50 mA
Storage Temperature Range (T_{STG})	-65°C to +150°C
Power Dissipation (P_D)	
(Note 3)	600 mW
S.O. Package only	500 mW
Lead Temperature (T_L)	
(Soldering 10 seconds)	260°C

Recommended Operating Conditions

	Min	Max	Units
Supply Voltage (V_{CC})	4.5	5.5	V
DC Input or Output Voltage (V_{IN}, V_{OUT})	0	V_{CC}	V
Operating Temperature Range (T_A)	-40	+85	°C
Input Rise or Fall Times (t_r, t_f)		500	ns

Note 1: Absolute Maximum Ratings are those values beyond which damage to the device may occur.**Note 2:** Unless otherwise specified all voltages are referenced to ground.**Note 3:** Power Dissipation temperature derating — plastic "N" package: -12 mW/°C from 65°C to 85°C.**DC Electrical Characteristics** $V_{CC} = 5V \pm 10\%$ (unless otherwise specified)

Symbol	Parameter	Conditions	$T_A = 25^\circ C$		$T_A = -40$ to $85^\circ C$	$T_A = -55$ to $125^\circ C$	Units
			Typ	Guaranteed Limits			
V_{IH}	Minimum HIGH Level Input Voltage			2.0	2.0	2.0	V
V_{IL}	Maximum LOW Level Input Voltage			0.8	0.8	0.8	V
V_{OH}	Minimum HIGH Level Output Voltage	$V_{IN} = V_{IL}$	V_{CC}	$V_{CC} - 0.1$	$V_{CC} - 0.1$	$V_{CC} - 0.1$	V
		$ I_{OUT} = 20 \mu A$	4.2	3.98	3.84	3.7	V
		$ I_{OUT} = 4.0$ mA, $V_{CC} = 4.5V$	5.2	4.98	4.84	4.7	V
V_{OL}	Maximum LOW Level Voltage	$V_{IN} = V_{IH}$	0	0.1	0.1	0.1	V
		$ I_{OUT} = 20 \mu A$	0.2	0.26	0.33	0.4	V
		$ I_{OUT} = 4.0$ mA, $V_{CC} = 4.5V$	0.2	0.26	0.33	0.4	V
I_{IN}	Maximum Input Current	$V_{IN} = V_{CC}$ or GND, V_{IH} or V_{IL}		± 0.1	± 1.0	± 1.0	μA
I_{CC}	Maximum Quiescent Supply Current	$V_{IN} = V_{CC}$ or GND, $I_{OUT} = 0 \mu A$		2.0	20	40	μA
		$V_{IN} = 2.4V$ or $0.5V$ (Note 4)		0.3	0.4	0.5	mA

Note 4: This is measured per input with all other inputs held at V_{CC} or ground.

AC Electrical Characteristics							
V _{CC} = 5.0V, t _r = t _f = 6 ns, C _L = 15 pF, T _A = 25°C (unless otherwise noted)							
Symbol	Parameter	Conditions	Typ	Guaranteed Limit	Units		
t _{PLH} , t _{PHL}	Maximum Propagation Delay		10	18	ns		
AC Electrical Characteristics							
V _{CC} = 5.0V ±10%, t _r = t _f = 6 ns, C _L = 50 pF (unless otherwise noted)							
Symbol	Parameter	Conditions	T _A = 25°C		T _A = -40 to 85°C	T _A = -55 to 125°C	Units
			Typ	Guaranteed Limits			
t _{PLH} , t _{PHL}	Maximum Propagation Delay		14	20	25	30	ns
t _{THL} , t _{TLH}	Maximum Output Rise & Fall Time		8	15	19	22	ns
C _{PD}	Power Dissipation Capacitance	(Note 5)	20				pF
C _{IN}	Input Capacitance		5	10	10	10	pF
<p>Note 5: C_{PD} determines the no load dynamic power consumption, P_D = C_{PD} V_{CC}² f + I_{CC} V_{CC}, and the no load dynamic current consumption, I_S = C_{PD} V_{CC} f + I_{CC}.</p>							

Physical Dimensions inches (millimeters) unless otherwise noted

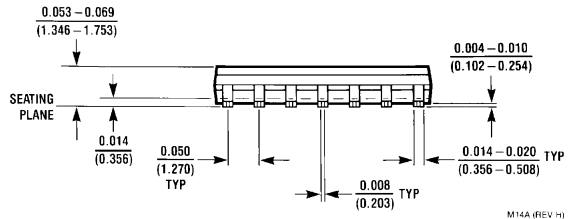
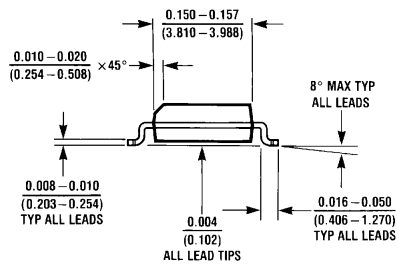
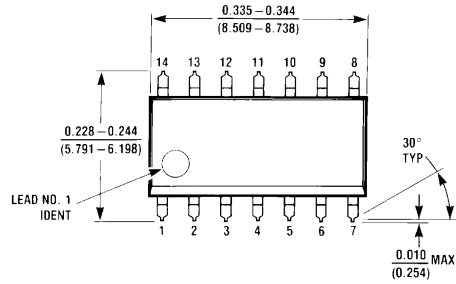

14-Lead Small Outline Integrated Circuit (SOIC), JEDEC MS-120, 0.150" Narrow Package Number M14A

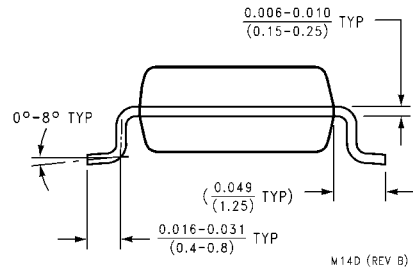
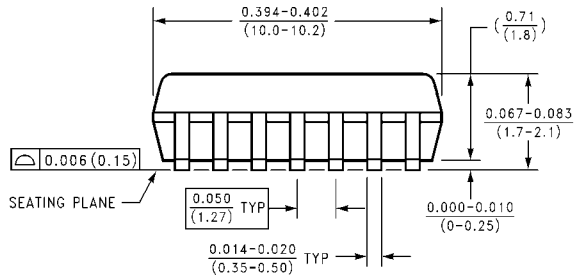
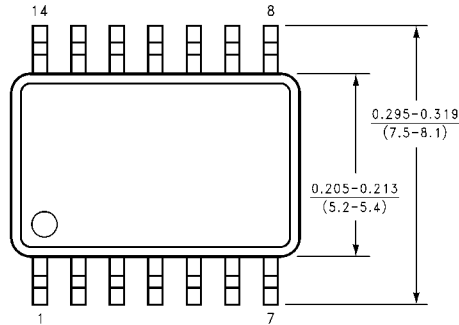

14-Lead Small Outline Package (SOP), EIAJ TYPE II, 5.3mm Wide Package Number M14D

Physical Dimensions inches (millimeters) unless otherwise noted (Continued)

14LD, TSSOP, JEDEC MO-153, 4.4MM WIDE

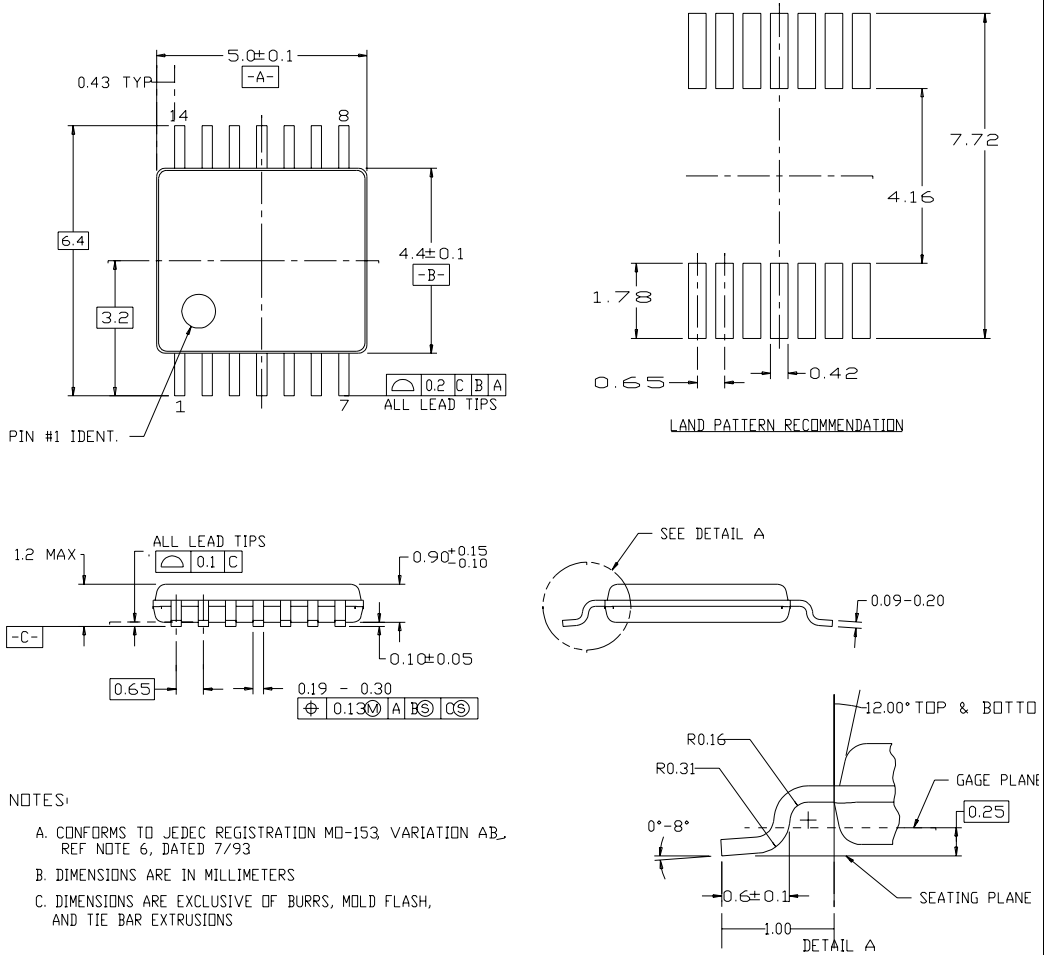

14-Lead Thin Shrink Small Outline Package (TSSOP), JEDEC MS-153, 4.4mm Wide Package Number MTC14

Physical Dimensions inches (millimeters) unless otherwise noted (Continued)

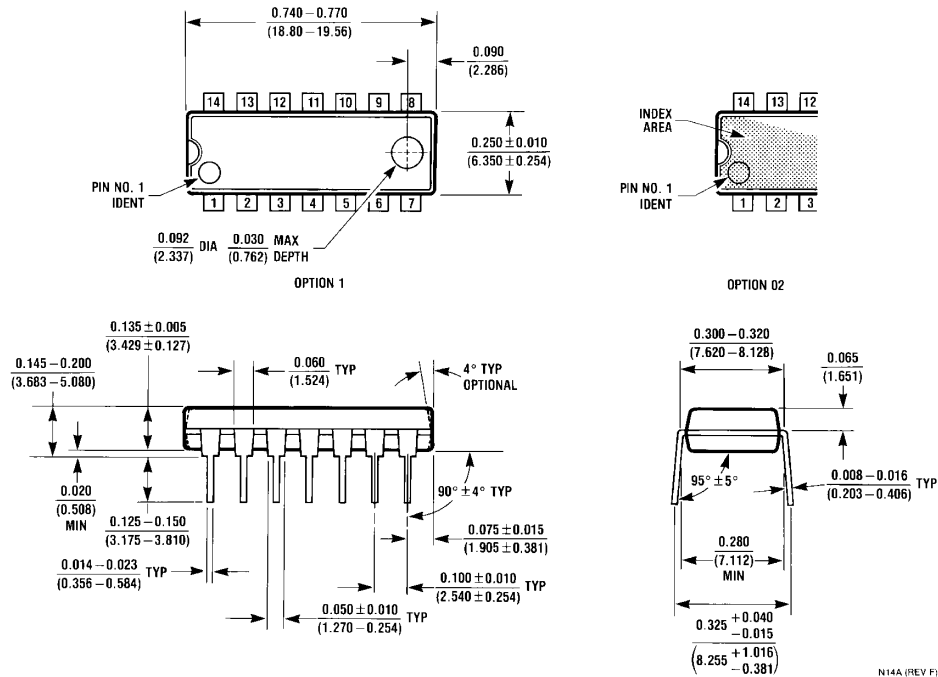

14-Lead Plastic Dual-In-Line Package (PDIP), JEDEC MS-001, 0.300" Wide Package Number N14A

LIFE SUPPORT POLICY

FAIRCHILD'S PRODUCTS ARE NOT AUTHORIZED FOR USE AS CRITICAL COMPONENTS IN LIFE SUPPORT DEVICES OR SYSTEMS WITHOUT THE EXPRESS WRITTEN APPROVAL OF THE PRESIDENT OF FAIRCHILD SEMICONDUCTOR CORPORATION. As used herein:

1. Life support devices or systems are devices or systems which, (a) are intended for surgical implant into the body, or (b) support or sustain life, and (c) whose failure to perform when properly used in accordance with instructions for use provided in the labeling, can be reasonably expected to result in a significant injury to the user.
2. A critical component in any component of a life support device or system whose failure to perform can be reasonably expected to cause the failure of the life support device or system, or to affect its safety or effectiveness.

www.fairchildsemi.com

This datasheet has been download from:

www.datasheetcatalog.com

Datasheets for electronics components.