

1	introduction	<i>introduction</i>
4	assurance qualité	<i>quality assurance</i>
5	diodes hyperfréquence	<i>microwave diodes</i>
8	varactors	<i>varactors</i>
11	diodes de contrôle	<i>control diodes</i>
17	diodes de réception	<i>receiving diodes</i>
20	diodes d'émission	<i>emitting diodes</i>
23	transistors à effet de champ	<i>field effect transistors</i>
29	fonctions microonde	<i>microwave assemblies</i>
31	oscillateurs	<i>oscillators</i>
33	amplificateurs	<i>amplifiers</i>
34	modules microonde	<i>microwave modules</i>
43	modules TO 8	<i>TO 8 modules</i>
45	composants optiques	<i>optical components</i>
51	lignes à retard	<i>delay lines</i>
55	composants à ferrite	<i>ferrite components</i>
57	dispositifs coaxiaux	<i>coaxial devices</i>
63	dispositifs sur guide	<i>waveguide devices</i>
66	dispositifs de puissance	<i>power devices</i>
69	dispositifs divers	<i>miscellaneous devices</i>
72	matériaux céramique	<i>ceramic materials</i>
77	réflecteurs et lentilles de luneberg	<i>luneberg reflectors and lenses</i>
81	compléments techniques	<i>design aid</i>
89	boîtiers	<i>case outlines</i>
97	index	<i>index</i>

L'évolution des composants hyperfréquence vers des dispositifs de plus en plus performants, entraîne un accroissement de la complexité des moyens d'étude et de production à mettre en œuvre. Cette évolution n'est possible que si la qualité est réelle, c'est-à-dire, si les produits livrés sont aptes à l'emploi dans les conditions normales de fonctionnement.

Le Service Assurance Qualité de la Division Composants Microonde a pour mission de surveiller l'élaboration des produits et de vérifier leur conformité aux documents de définition.

Ce service, distinct des services opérationnels de conception et de réalisation permet de fournir ainsi des composants hyperfréquence dont la qualité est appréciée dans les faisceaux hertziens, les télécommunications, les radars, les missiles, les contre-mesures et de nombreuses autres activités d'électronique professionnelle.

La Division Composants Microonde de THOMSON-CSF participe depuis une dizaine d'années aux activités spatiales, dans de nombreux pays, en livrant des composants de haute fiabilité tels que diodes et transistors, fonctions microélectronique hyperfréquence, dispositifs à ferrite... dans les principaux programmes, rappelés ci-dessous.

Performance upgrading of microwave components has called for even more sophisticated study and production facilities. Development as such is only possible if the quality is an inherent part of the product, i.e., the products supplied are suitable for service under standard operating conditions. Our Quality Assurance Department has the task of supervising products development and checking their conformity to specifications. Tanks to this department, independent from the design and production departments, high quality microwave components are supplied to be used in application fields such as: radio links, telecommunications, radars, missiles, countermeasures and numerous other electronic applications. For more than ten years, THOMSON-CSF Microwave Component Division has participated in spatial programs in numerous countries by supplying highly reliable components, such as diodes and transistors, microwave assemblies, ferrite devices, etc.... used in the following main programmes.

	ARIANE	ECS	MARECS	MAROTS	OTS	SIRIO	SYMPHONIE	TELECOM 1	ISEE	ARGOS	GEOS	HELIOS	METEOSAT	TDRSS	EXOSAT
DIODES ET MICROELECTRONIQUE HYPERFREQUENCE MICROWAVE DIODES AND MIC'S	●	●	●	●	●	●	●	●		●	●	●	●	●	●
ISOLATEURS ET CIRCULATEURS A FERRITE FERRITE ISOLATORS AND CIRCULATORS			●	●	●		●	●	●		●	●		●	

diodes hyperfréquence
microwave diodes

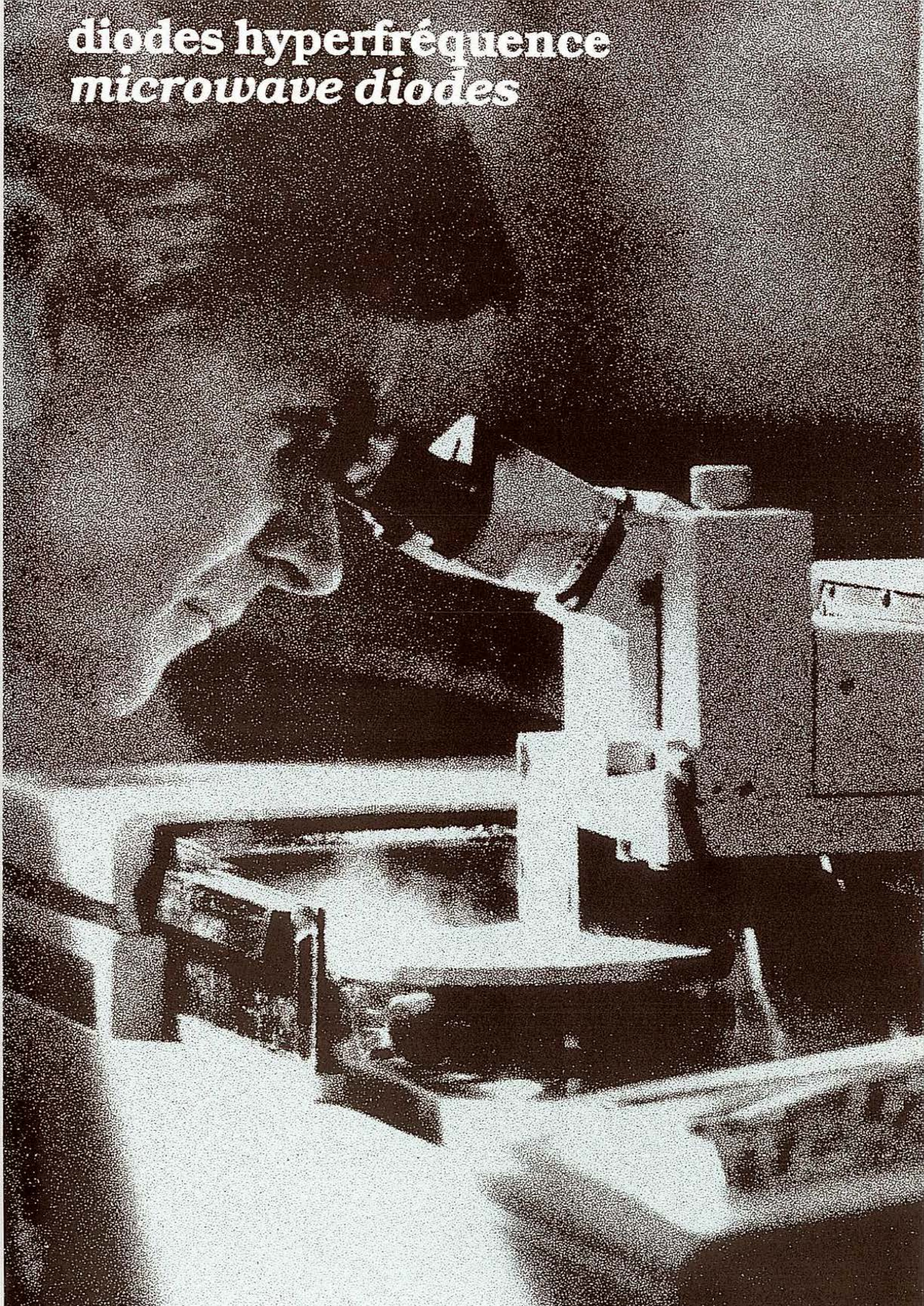

La Division Composants Microonde de THOMSON-CSF a développé une gamme complète de diodes hyperfréquence couvrant les applications en réception, contrôle et émission.

Les pages suivantes regroupent, en fonction de ces applications, les caractéristiques générales de ces produits. Les varactors, font l'objet d'une rubrique particulière.

- L'utilisation industrielle d'une nouvelle technique d'épitanie en phase gazeuse sous basse pression a permis de réaliser, en arséniure de gallium, des dispositifs performants et reproductibles tels que les diodes mélangeuses DH 378 utilisées en réception sur le satellite TDRSS, les varactors AH 106, 108 et 110 pour l'amplification paramétrique...

- En matériau silicium, la Division Composants Microonde possède une famille très complète de diodes PIN dont certains types ont été produits en grandes quantités pour des antennes radars à balayage électronique. La famille des diodes avalanche double-drift pour les applications millimétriques est en cours d'extension vers les fréquences voisines de 94 GHz grâce à l'épitanie en phase gazeuse sous basse pression appliquée au matériau silicium.

L'ensemble de ces produits peut être livré, sur demande, sous des encapsulations diverses.

THOMSON-CSF Microwave Component Division has developed a complete range of microwave diodes covering all transmission, reception and control applications.

The general specifications of these products are listed in the following pages as a function of these applications. A special chapter is dedicated to varactors.

- *Industrial use of a new low pressure vapor phase epitaxy technique has made it possible to produce high performance and repeatable gallium arsenide devices, such as DH 378 mixer diodes used for reception purposes in the TDRSS satellite, AH 106, AH 108 and AH 110 varactors for parametric amplification.*

- *The Microwave Component Division provides a full range of silicon PIN diodes. Certain types of these diodes have been mass-produced for phased array radars. The double drift avalanche diode family for millimeter applications is being extended to frequencies of about 94 GHz, thanks to the low pressure vapor phase epitaxy technique used on silicon.*

All these products can be supplied in various cases upon request.

symboles**symbols**

TENSIONS		VOLTAGES	
V_F	TENSION DIRECTE CONTINUE		FORWARD CONTINUOUS VOLTAGE
V_R	TENSION INVERSE CONTINUE		REVERSE CONTINUOUS VOLTAGE
V_{BR}	TENSION DE CLAQUAGE		BREAKDOWN VOLTAGE
V_N	LA COURBE C (V) (ÉCHELLE LOG-LOG) PRÉSENTE UN POINT D'INFLEXION POUR $V = V_N$ (DIODES D'ACCORD)		THE C (V) GRAPH (LOG-LOG SCALE) SHOWS AN INFLEXION POINT FOR $V = V_N$ (TUNING DIODES)
COURANTS		CURRENTS	
I_F	COURANT DIRECT CONTINU		FORWARD CONTINUOUS CURRENT
I_R	COURANT INVERSE CONTINU		REVERSE CONTINUOUS CURRENT
PUISSANCE		POWER	
P_E	PUISSANCE EN ENTRÉE		INPUT POWER
P_O	PUISSANCE EN SORTIE		OUTPUT POWER
$P_{diss.}$	PUISSANCE DISSIPÉE		POWER DISSIPATION
P_{rfmax}	PUISSANCE RF MAXIMUM ADMISSIBLE		MAXIMUM RF POWER
$P_{L.O.}$	PUISSANCE DE L'OSCILLATEUR LOCAL		LOCAL OSCILLATOR POWER
PARAMÈTRES DE COMMUTATION		SWITCHING PARAMETERS	
τ_I	DURÉE DE VIE DES PORTEURS MINORITAIRES		MINORITY CARRIER LIFETIME
t_{so}	TEMPS DE RETOUR RAPIDE		SNAP-OFF TIME
t_{cr}	TEMPS DE COMMUTATION INVERSE		REVERSE SWITCHING TIME
GRANDEURS DIVERSES		ADDITIONAL ITEMS	
r_{SF}	RÉSISTANCE SÉRIE DANS LE SENS DIRECT		FORWARD SERIES RESISTANCE
r_{SR}	RÉSISTANCE SÉRIE DANS LE SENS INVERSE		REVERSE SERIES RESISTANCE
R_V	RÉSISTANCE VIDÉO		VIDEO RESISTANCE
R_{th}	RÉSISTANCE THERMIQUE		THERMAL RESISTANCE
C_i	CAPACITÉ DE JONCTION		JUNCTION CAPACITANCE
C_T	CAPACITÉ TOTALE		TOTAL CAPACITANCE
C_{T1}/C_{T2}	RAPPORT DES CAPACITÉS TOTALES POUR LES TENSIONS V_1 ET V_2		TUNING RATIO FOR TWO-REVERSE VOLTAGES V_1, V_2
Q	FACTEUR DE QUALITÉ		QUALITY FACTOR
α_c	COEFFICIENT DE TEMPÉRATURE DES DIODES A CAPACITÉ VARIABLE		TEMPERATURE COEFFICIENT OF CAPACITANCE
γ	PENTE DE LA COURBE C (V) POUR $V = V_N$		SLOPE OF THE C (V) GRAPH FOR $V = V_N$
f_c	FRÉQUENCE DE COUPURE		CUT-OFF FREQUENCY
f_{c-6}	FRÉQUENCE DE COUPURE ($V = -6$ V)		CUT-OFF FREQUENCY ($V = -6$ V)
f_E	FRÉQUENCE D'ENTRÉE		INPUT FREQUENCY
f_O	FRÉQUENCE DE SORTIE		OUTPUT FREQUENCY
T_{ss}	SENSIBILITÉ TANGENTIELLE		TANGENTIAL SENSITIVITY
R.O.S. V.S.W.R.	RAPPORT D'ONDE STATIONNAIRE		STANDING WAVE RATIO
NF_o	FACTEUR DE BRUIT EN SIMPLE BANDE		SSB NOISE FIGURE
f	FRÉQUENCE		FREQUENCY
Z_{if}	IMPÉDANCE A LA FRÉQUENCE INTERMÉDIAIRE		INTERMEDIATE FREQUENCY IMPEDANCE
M	COEFFICIENT DE MÉRITE		FIGURE OF MERIT
R_A	RÉSISTANCE ÉQUIVALENTE DE BRUIT DE L'AMPLIFICATEUR VIDÉO		VIDEO AMPLIFIER NOISE EQUIVALENT RESISTANCE
R_L	RÉSISTANCE DE CHARGE		LOAD RESISTANCE

varactors

varactors



F 27d

E 4p

E 5p

varactors multiplicateurs à l'arséniure de gallium gallium arsenide multiplier varactors

CONDITIONS DE MESURES TEST CONDITIONS				$I_R = 10 \mu A$		$V_R = 3 V$		$V = 0 V$ $f = 1 MHz$		$f_E = 10 GHz$ $f_o = 3 f_E$		CONDITIONS LIMITES LIMITING CONDITIONS	
CARACTERISTIQUES A SPECIFICATIONS AT				$T = 25^\circ C$		V_{BR}	I_R	C_j	C_j	P_E	P_O	TEMPERATURES $^\circ C$ TEMPERATURES $^\circ C$	
TYPE TYPE	BOITIER CASE	Nbre DE VARACTORS Nber OF VARACTORS	FRÉQUENCE FREQUENCY GHz	V min	μA max	pF min	pF max	mW max	mW min	FONCTION OPERATING	STOCKAGE STORAGE		
AH 131	F 27 d		30-40	10	0.1	0.2	0.5	100	15				
AH 132	F 27 d		30-40	10	0.1	0.2	0.5	100	25				
AH 133	F 27 d		30-40	15	0.1	0.2	0.5	150	40				
AH 134	F 27 d		30-40	15	0.1	0.2	0.5	350	100	-40+70	-65+175		
AH 135	F 27 d		30-40	20	0.1	0.3	0.7	500	150				
AH 141	E 4 p	2	30-40	30	0.1	0.2	0.4	0.8	200				
AH 142	E 5 p	3	30-40	45	0.1	0.15	0.3	1.2	300				

varactors multiplicateurs au silicium silicon multiplier varactors

CONDITIONS DE MESURES TEST CONDITIONS				$I_R = 10 \mu A$		$V_R = -6 V$ $I = 1 MHz$		$+10 mA$ $-6 mA$		$+10 mA$ $-10 V$		$f_O = f_E$		CONDITIONS LIMITES LIMITING CONDITIONS	
CARACTERISTIQUES A SPECIFICATIONS AT				$T = 25^\circ C$		V_{BR}	C_j	τ_i	I_{SO}	R_{th}	P_O	TEMPERATURES $^\circ C$ TEMPERATURES $^\circ C$			
TYPE TYPE	BOITIER CASE	Nbre DE VARACTORS Nber OF VARACTORS	FRÉQUENCE FREQUENCY GHz	V min	V max	pF min	pF max	ns min	ps max	$^\circ C/W$ max	W	FONCTION OPERATING	STOCKAGE STORAGE		
DH 238 G	F 49 p	2	2-4	120	160	3	5	200	400	10	14				
DH 239 G	F 49 p	2	3-5	90	130	2	4	150	200	12	10				
DH 240 G	F 49 p	2	2-6	80	120	1.4	2.4	150	200	17	6				
DH 241 G	F 27 d	2	4-8	70	110	0.9	1.4	60	150	20	4				
DH 242 G	F 27 d	2	8-12	60	90	0.4	0.6	30	100	25	1.7				
DH 243 G	F 27 d	2	12-18	50	70	0.2	0.4	20	80	40	0.6				
DH 236	E 2 p	2	1-3	160	220	4	6	400	600	6	20				
DH 240	E 1 p	2	4-6	80	120	1.4	2.4	150	200	17	6				
DH 241	E 1 p	2	4-8	70	110	0.9	1.4	60	150	20	4				
DH 242	E 1 p	2	8-12	60	90	0.4	0.6	30	100	25	1.7				
DH 243	E 1 p	2	12-18	50	70	0.2	0.4	20	80	40	0.6				
DH 245	E 3 p	3	9-14	90	120	0.4	0.6	30	100	25	3				
DH 246	E 3 p	3	12-18	70	100	0.25	0.4	20	80	35	1.2	-55+175	-65+200		
DH 286	E 2 p	4	2-6	180	280	0.9	1.3	150	200	6	25 (d)				
DH 287	E 1 p	4	6-12	120	180	0.4	0.7	60	150	13	8 (d)				
DH 288	E 1 p	4	12-18	90	140	0.2	0.4	30	80	25	3 (d)				
DH 294	DO 7	1	0.2-2	45	70	6	10	125	400	300	0.5(d)				
DH 200	F 49	1	0.5-2	90	140	5.5	7	250	1000	8	20 (d)				
DH 270	S 268-W1	1	2-3	80	110	4	5.5	160	700	10	15 (d)				
DH 110	F 27 d	1	2-4	60	90	3	4	100	400	25	9 (d)				
DH 293	F 60 d	1	3-6	50	70	2	3	60	250	30	6 (d)				
DH 252	F 27 d	1	2-8	40	60	0.9	2	35	200	50	3 (d)				
DH 256	F 27 d	1	5-12	30	45	0.5	1.1	20	120	60	2 (d)				
DH 292	F 27 d	1	8-16	20	35	0.2	0.5	10	75	70	0.6(d)				
DH 267	F 27 d	1	10-25	15	25	0.2	0.3	6	60	100	0.2(d)				

(d) En doubleur

(d) Doubler test

varactors multiplicateurs et de commutation au silicium, en microéléments silicon multiplier and switching varactors, microcomponents

CONDITIONS DE MESURES TEST CONDITIONS		$10 mA$ $-6 mA$		$+10 mA$ $-10 V$		$I_R = 10 \mu A$		$V_R = 6 V$ $f = 1 MHz$		CONDITIONS LIMITES LIMITING CONDITIONS		
CARACTERISTIQUES A SPECIFICATIONS AT		$T = 25^\circ C$		τ_i	I_{SO}	V_{BR}	C_j	C_j	P_E	P_O	TEMPERATURES $^\circ C$ TEMPERATURES $^\circ C$	
TYPE TYPE	PRÉSENTATION CONFIGURATION	ns typ	ps typ	V min	pF min	pF max	FONCTION OPERATING	STOCKAGE STORAGE				
EH 255	C 2	40	120	40	0.8	1.4						
EH 256	C 2	20	90	30	0.5	0.8	-55+175	-65+200				
EH 257	C 2	15	80	25	0.3	0.5						
EH 258	C 2	10	70	20	0.15	0.3						



F 49p

E 2p

E 1p

E 3p

DO 7

F 49

varactors paramétriques à l'arséniure de gallium gallium arsenide parametric varactors

CONDITIONS DE MESURES TEST CONDITIONS		$V_R = 6\text{ V}$	$I_R = 10\ \mu\text{A}$	$V_R = 3\text{ V}$	$V = 0\text{ V}$ $f = 1\text{ MHz}$	$V_{R1} = 0\text{ V}$ $V_{R2} = 6\text{ V}$	CONDITIONS LIMITES LIMITING CONDITIONS		
CARACTÉRISTIQUES A SPECIFICATIONS AT		$T = 25\ ^\circ\text{C}$	f_c	V_{BR}	I_R	C_j	C_j	$\frac{C_{j1} - C_{j2}}{C_{j1}}$	TEMPÉRATURES $^\circ\text{C}$ TEMPERATURES $^\circ\text{C}$
TYPE TYPE	BOITIER CASE	GHz min	V min	μA max	pF min	pF max	min	FONCTION OPERATING	STOCKAGE STORAGE
AH 106	F 54	600	6	1	0.2	0.3	0.45		
AH 108	F 54	600	6	1	0.3	0.4	0.5	- 55 + 70	- 65 + 150
AH 110	F 54	1000	6	1	0.2	0.3	0.5		

varactors paramétriques au silicium silicon parametric varactors

CONDITIONS DE MESURES TEST CONDITIONS			$I_R = 10\ \mu\text{A}$	$V_R = 0\text{ V}$ $f = 1\text{ MHz}$	$V_R = 0\text{ V}$ $f = 2.75\text{ GHz}$	$V_R = -6\text{ V}$ $f = 2.75\text{ GHz}$	CONDITIONS LIMITES LIMITING CONDITIONS		
CARACTÉRISTIQUES A SPECIFICATIONS AT		$T = 25\ ^\circ\text{C}$	V_{BR}	C_j	C_j	f_{co}	$f_c - 6$	TEMPÉRATURES $^\circ\text{C}$ TEMPERATURES $^\circ\text{C}$	
TYPE TYPE	BOITIER CASE	FRÉQUENCE FREQUENCY GHz	V min	pF min	pF max	GHz	GHz	FONCTION OPERATING	STOCKAGE STORAGE
DH 751	F 27 d	1-2	6	0.9	1.1	50	125		
DH 752	F 27 d	2-4	6	0.5	0.7	70	150		
DH 753	F 27 d	4-8	12	0.2	0.3	100	200	- 55 + 150	- 65 + 200
DH 755	F 27 d	4-8	12	0.3	0.5	100	200		
DH 756	F 27 d	8-12	12	0.1	0.2	250	500		

varactors limiteurs au silicium silicon limiter varactors

CONDITIONS DE MESURES TEST CONDITIONS			$I_R = 10\ \mu\text{A}$	$V_R = -6\text{ V}$ $f = 1\text{ MHz}$	$V_R = -6\text{ V}$ $f = 2.75\text{ GHz}$	CONDITIONS LIMITES LIMITING CONDITIONS					
CARACTÉRISTIQUES A SPECIFICATIONS AT		$T = 25\ ^\circ\text{C}$	V_{BR}	V_{BR}	C_j	C_j	$f_c - 6$	R_{th}	P_{diss}	TEMPÉRATURES $^\circ\text{C}$ TEMPERATURES $^\circ\text{C}$	
TYPE TYPE	BOITIER CASE	FRÉQUENCE FREQUENCY GHz	V min	V max	pF min	pF max	GHz min	$^\circ\text{C/W}$ max	W max	FONCTION OPERATING	STOCKAGE STORAGE
DH 601	F 27 d	6	30	45	0.2	0.5	150	90	0.75		
DH 602	F 27 d	6	30	45	0.2	0.5	200	90	0.75		
DH 603	F 27 d	8	60	90	0.2	0.5	80	70	1	- 55 + 150	- 65 + 175
DH 604	F 27 d	8	60	90	0.2	0.5	150	70	1		
DH 605	F 27 d	10	90	120	0.2	0.5	100	50	1.5		
DH 606	F 27 d	12	120	150	0.2	0.5	100	40	2		

varactors limiteurs au silicium en microéléments silicon limiter varactors, microcomponents

CONDITIONS DE MESURES TEST CONDITIONS			$I_R = 10\ \mu\text{A}$	$V_R = 0\text{ V}$ $f = 1\text{ MHz}$	$V_R = 0\text{ V}$ $f = 2.75\text{ GHz}$	CONDITIONS LIMITES LIMITING CONDITIONS	
CARACTÉRISTIQUES A SPECIFICATIONS AT		$T = 25\ ^\circ\text{C}$	V_{BR}	C_j	C_j	f_c	TEMPÉRATURES $^\circ\text{C}$ TEMPERATURES $^\circ\text{C}$
TYPE TYPE	PRÉSENTATION CONFIGURATION	V min	pF min	pF max	GHz min	FONCTION OPERATING	STOCKAGE STORAGE
EH 624	C 2	25	0.2	0.3	140	- 55 + 150	- 65 + 175
EH 625	C 2	25	0.1	0.2	180		



F 54

S 268 (W1)

F 60d

varactors varactors



F 27d

F 49

varactors transposeurs de fréquence au silicium silicon up-conversion varactors

CONDITIONS DE MESURES TEST CONDITIONS		$I_R = 10 \mu A$	$V_R = -6 V$ $f = 1 MHz$			$V_R = -6 V$	CONDITIONS LIMITEES LIMITING CONDITIONS			
CARACTÉRISTIQUES A SPECIFICATIONS AT		$T = 25 ^\circ C$	V_{BR}	C_j	C_j	f_{c-6}	PERTQS CONVERSION LOSS	P_{diss}	TEMPÉRATURES $^\circ C$ TEMPERATURES $^\circ C$	
TYPE TYPE	BOITIER CASE	FREQUENCE FREQUENCY GHz	V min	pF min	pF max	GHz min	dB typ	W	FONCTION OPERATING	STOCKAGE STORAGE
DH 631	F 27 d	1	90	5	7.5	35	3	5		
DH 631 B	F 49	1	90	5	7.5	35	3	7		
DH 632	F 27 d	2	90	3	5	50	3	5		
DH 632 B	F 49	2	90	3	5	50	3	7		
DH 633	F 27 d	4	70	1.5	2.5	80	3.5	2.5		
DH 633 B	F 49	4	70	1.5	2.5	80	3.5	3.5		
DH 634	F 27 d	6	50	0.8	1.2	140	4	1.5	-55 + 150	-65 + 175
DH 634 B	F 49	6	50	0.8	1.2	140	4	2		
DH 635	F 27 d	8	40	0.7	0.9	180	4	1		
DH 635 B	F 49	8	40	0.7	0.9	180	4	1.5		
DH 636	F 27 d	10	40	0.6	0.8	200	4.5	1		
DH 637	F 27 d	13	25	0.4	0.6	250	5.4	1		

diodes de contrôle control diodes



A 22e

F 27sa

F 32b

diodes PIN de commutation rapide PIN fast switching diodes

CONDITIONS DE MESURES TEST CONDITIONS		20 mA - 10 V/50 Ω	$I_F = 100 \text{ mA}$	$I_R = 10 \text{ } \mu\text{A}$	$V_R = 50 \text{ V}$ $f = 1 \text{ MHz}$	CONDITIONS LIMITES LIMITING CONDITIONS		
CARACTÉRISTIQUES A SPECIFICATIONS AT		$T = 25 \text{ }^\circ\text{C}$	t_{cr}	t_{SF}	V_{BR}	C_T	R_{th}	TEMPÉRATURES $^\circ\text{C}$ TEMPERATURES $^\circ\text{C}$
TYPE	BOITIER CASE	ns typ	μs max	V min	pF max	$^\circ\text{C/W}$ max	FONCTION OPERATING	STOCKAGE STORAGE
DH 401	F 27 d	15	1	100	0.4	60		
DH 401 B	A 22 e	15	1	100	0.3			
DH 402	F 27 d	25	1	150	0.4	50		
DH 402 B	A 22 e	25	1	150	0.3			
DH 405	F 27 d	15	1.2	150	0.3	70		
DH 405 B	A 22 e	15	1.2	150	0.2			
DH 403	F 27 d	50	1	200	0.4	40	- 55 + 150	- 65 + 175
DH 403 B	A 22 e	50	1	200	0.3			
DH 404	F 27 d	70	1.5	250	0.28	40		
DH 407	F 27 d	70	1.2	250	0.36	35		
DH 408	F 27 d	70	1	250	0.4	30		
DH 409	F 27 d	70	0.8	250	0.45	25		

diodes PIN de commutation ultra-rapide PIN ultra-fast switching diodes

CONDITIONS DE MESURES TEST CONDITIONS		20 mA - 10V/50 Ω	$I_F = 20 \text{ mA}$	$I_R = 10 \text{ } \mu\text{A}$	$V_R = 6 \text{ V}$	$V_{RR} = 0 \text{ V}$	CONDITIONS LIMITES LIMITING CONDITIONS		
CARACTÉRISTIQUES A SPECIFICATIONS AT		$T = 25 \text{ }^\circ\text{C}$	t_{cr}	t_{SF}	V_{BR}	C_T	C_T	R_{th}	TEMPÉRATURES $^\circ\text{C}$ TEMPERATURES $^\circ\text{C}$
TYPE	BOITIER CASE	ns typ	μs max	V min	pF max	pF max	$^\circ\text{C/W}$ max	FONCTION OPERATING	STOCKAGE STORAGE
DH 531	F 27 d	4	1.2	50	0.6	0.8	60		
DH 531 B	A 22 e	4	1.2	50	0.4	0.6			
DH 532	F 27 d	6	1	70	0.6	0.8	60	- 55 + 150	- 65 + 200
DH 532 B	A 22 e	6	1	70	0.4	0.6			

diodes PIN de commutation et de déphasage (moyenne et forte puissance) PIN switching and phase shifting diodes (medium and high power)

CONDITIONS DE MESURES TEST CONDITIONS		20 mA - 10 V/50 Ω	10 mA - 6 mA	$V_R = 50 \text{ V}$	$I_F = 100 \text{ mA}$	$I_R = 10 \text{ mA}$	$V_R = 50 \text{ V}$ $f = 1 \text{ MHz}$	CONDITIONS LIMITES LIMITING CONDITIONS			
CARACTÉRISTIQUES A SPECIFICATIONS AT		$T = 25 \text{ }^\circ\text{C}$	t_{cr}	τ_i	t_{SR}	t_{SF}	V_{BR}	C_T	R_{th}	TEMPÉRATURES $^\circ\text{C}$ TEMPERATURES $^\circ\text{C}$	
TYPE	BOITIER CASE	ns typ	μs typ	Ω max	Ω max	V min	pF min	pF max	$^\circ\text{C/W}$ max	FONCTION OPERATING	STOCKAGE STORAGE
DH 441	F 27 d	150	1	1	1	500	0.35	0.45	15		
DH 442	F 27 d	200	1	1	1	500	0.27	0.33	20		
DH 443	F 27 d	200	2	1	0.7	500	0.35	0.45	15		
DH 438	F 27 d	250	2	1	0.5	500	0.5	0.7	15		
DH 437	F 27 d	250	2	1	0.5	500	0.4	0.6	100		
DH 439	F 27 d	250	2	1	0.5	700	0.5	0.7	15	- 55 + 150	- 65 + 200
DH 451	F 27 d	300	2	1.5	1.5	900	0.27	0.33	15		
DH 453	F 27 d	300	3	1	0.6	900	0.4	0.6	15		
DH 454	F 27 d	350	5	1	0.6	1200	0.5	0.7	15		
DH 482	F 27 SA	500	7	1	0.8	1800	0.6	0.8	15		

diodes de commutation rapides high speed switching diodes

CONDITIONS DE MESURES TEST CONDITIONS		20 mA - 10V/50Ω	$I_R = 10 \text{ } \mu\text{A}$	$V_R = 30 \text{ V}$ $f = 1 \text{ MHz}$	$I_F = 20 \text{ mA}$	$I_F = 20 \text{ mA}$	$V_R = - 10 \text{ V}$	CONDITIONS LIMITES LIMITING CONDITIONS			
CARACTÉRISTIQUES A SPECIFICATIONS AT		$T = 25 \text{ }^\circ\text{C}$	FREQUENCE FREQUENCY	t_{cr}	P_{diss}	V_{BR}	C_T	t_{SF}	PERTES Insertion loss.	DÉCOUPL. ISOLATION	TEMPÉRATURES $^\circ\text{C}$ TEMPERATURES $^\circ\text{C}$
TYPE	BOITIER CASE	GHz	ns typ	W	V min	pF typ	Ω typ	dB typ	dB typ	FONCTION OPERATING	STOCKAGE STORAGE
DH 582	F 32 b	10	8	0.6	80	0.14	1.5	0.5	30		
DH 583	F 32 b	12	6	0.5	80	0.12	2	0.5	30		
DH 584	F 32 b	15	5	0.4	80	0.105	2.5	0.5	30	- 25 + 70	- 40 + 100
DH 585	F 32 b	18	4	0.4	80	0.095	3	0.5	30		

diodes de contrôle control diodes

diodes PIN pour atténuation PIN attenuating diodes

CONDITIONS DE MESURES TEST CONDITIONS		$I_F = 0.1 \text{ mA}$	$I_F = 1 \text{ mA}$	$I_F = 10 \text{ mA}$	$V_R = 50 \text{ V}$ $f = 1 \text{ MHz}$	$V_R = 100 \text{ V}$	10 mA^* -6 mA	CONDITIONS LIMITES LIMITING CONDITIONS					
CARACTÉRISTIQUES A SPECIFICATIONS AT		$T = 25^\circ\text{C}$		t_{SF}	t_{SF}	t_{SF}	C_T	I_R	τ_L	TEMPÉRATURES °C TEMPERATURES °C			
TYPE TYPE	BOITIER CASE	Ω min	Ω max	Ω min	Ω max	Ω min	Ω max	pF min	pF max	μA max	μs typ	FONCTION OPERATING	STOCKAGE STORAGE
DH 488	F 27 d	70	140	8	16	1	2	0.5	0.7	10	2		
DH 489	F 27 d	120	240	15	30	2.1	4.2	0.4	0.6	10	3		
DH 491	DO 7	120	240	15	30	2.1	4.2	0.3	0.7	10	5		
DH 493	A 22 e	200	400	25	50	3.5	7	0.2	0.4	10	4	-55 + 150	-65 + 175
DH 495	F 27 d	120	240	15	30	2.1	4.2	0.4	0.8	10	5		
DH 496	F 27 d	400	800	50	100	6.5	13	0.3	0.5	10	7		

diodes PIN pour la commutation et l'atténuation PIN attenuating and switching diodes

CONDITIONS DE MESURES TEST CONDITIONS		$f = 9 \text{ GHz}$	$I = 25 \text{ mA}$ $P_E = 1 \text{ mW}$	$V_R = 0 \text{ V}$ $P_E = 1 \text{ mW}$	CONDITIONS LIMITES LIMITING CONDITIONS					
CARACTÉRISTIQUES A SPECIFICATIONS AT		$T = 25^\circ\text{C}$		BANDE DE FRÉQUENCE FREQUENCY RANGE	DÉCOUPLAGE ISOLATION	PERTES INSERTION LOSS	R.O.S V.S.W.R	P_E	TEMPÉRATURES °C TEMPERATURES °C	
TYPE TYPE	BOITIER CASE	POLARITÉ POLARITY	GHz	dB typ	dB typ	dB typ	typ	W max	FONCTION OPERATING	STOCKAGE STORAGE
MH 151	BMH 76	cathode à la masse cathode to ground	1 - 18	20	0.5	1.5	30		-55 + 150	-65 + 175
MH 153	BMH 76	anode à la masse anode to ground	1 - 18	20	0.5	1.5	30			

diodes PIN de commutation rapide, en microéléments PIN fast switching diodes, microcomponents

CONDITIONS DE MESURES TEST CONDITIONS		20 mA $-10 \text{ V}/50 \Omega$	$I_F = 100 \text{ mA}$	$I_R = 10 \mu\text{A}$	$V_R = 50 \text{ V}$ $f = 1 \text{ MHz}$	CONDITIONS LIMITES LIMITING CONDITIONS			
CARACTÉRISTIQUES A SPECIFICATIONS AT		$T = 25^\circ\text{C}$		t_{cr}	t_{SF}	V_{BR}	C_j	C_j	TEMPÉRATURES °C TEMPERATURES °C
TYPE TYPE	PRÉSENTATION CONFIGURATION	ns typ	Ω typ	V min	pF min	pF max	FONCTION OPERATING	STOCKAGE STORAGE	
EH 404	C2	70	1.5	200	0.04	0.08			
EH 407	C2	70	1.2	200	0.08	0.16			
EH 408	C2	70	1	200	0.16	0.2	-55 + 150	-65 + 175	
EH 409	C2	70	0.8	200	0.2	0.25			

diodes PIN de commutation et de déphasage (moyenne et forte puissance), en microéléments PIN switching and phase shifting diodes (medium and high power), microcomponents

CONDITIONS DE MESURES TEST CONDITIONS		20 mA $-10/50 \Omega$	10 mA -6 mA	$V_R = 50 \text{ V}$	$I_F = 100 \text{ mA}$	$I_R = 10 \mu\text{A}$	$V_R = 50 \text{ V}$ $f = 1 \text{ MHz}$	CONDITIONS LIMITES LIMITING CONDITIONS		
CARACTÉRISTIQUES A SPECIFICATIONS AT		$T = 25^\circ\text{C}$		t_{cr}	τ_I	t_{SR}	t_{SF}	V_{BR}	C_j	TEMPÉRATURES °C TEMPERATURES °C
TYPE TYPE	PRÉSENTATION CONFIGURATION	ns typ	μs typ	Ω max	Ω max	V min	pF min	pF max	FONCTION OPERATING	STOCKAGE STORAGE
EH 424	C2	150	1	1	1	500	0.15	0.25		
EH 426	C2	250	2	1	0.5	700	0.30	0.50		
EH 428	C2	300	2	1.5	1.5	900	0.08	0.15	-55 + 150	-65 + 200
EH 429	C2	300	3	1	0.6	900	0.2	0.4		

diodes PIN pour atténuation, en microéléments PIN attenuating diodes, microcomponents

CONDITIONS DE MESURES TEST CONDITIONS		$I_F = 0.1 \text{ mA}$	$I_F = 1 \text{ mA}$	$I_F = 10 \text{ mA}$	$V_R = 50 \text{ V}$ $f = 1 \text{ MHz}$	$V_R = 100 \text{ V}$	10 mA -6 mA	CONDITIONS LIMITES LIMITING CONDITIONS					
CARACTÉRISTIQUES A SPECIFICATIONS AT		$T = 25^\circ\text{C}$		t_{SF}	t_{SF}	t_{SF}	C_j	I_R	τ_L	TEMPÉRATURES °C TEMPERATURES °C			
TYPE TYPE	PRÉSENTATION CONFIGURATION	Ω min	Ω max	Ω min	Ω max	Ω min	Ω max	pF min	pF max	μA max	μs typ	FONCTION OPERATING	STOCKAGE STORAGE
EH 488	C4	70	140	8	16	1	2	0.3	0.5	10	2		
EH 491	C4	120	240	15	30	2.1	4.2	0.2	0.35	10	3		
EH 493	C4	200	400	25	50	3.5	7	0.15	0.30	10	4	-55 + 150	-65 + 175
EH 496	C4	400	800	50	100	6.5	13	0.1	0.2	10	7		



F 27d

DO 7

A 22e

diodes PIN de commutation rapide en beam-lead PIN switching beam-lead diodes

CONDITIONS DE MESURES TEST CONDITIONS		10 mA - 10 V/50 Ω	$I_F = 50 \text{ mA}$	$I_R = 10 \mu\text{A}$	$V_R \begin{cases} - 50 \text{ V} \\ - 10 \text{ V} \end{cases}$ $f = 1 \text{ MHz}$	CONDITIONS LIMITES LIMITING CONDITIONS	
CARACTÉRISTIQUES A SPECIFICATIONS AT		$T = 25^\circ\text{C}$	t_{cr}	r_{SF}	V_{BR}	C_T	TEMPÉRATURES °C TEMPERATURES °C
TYPE TYPE	PRÉSENTATION CONFIGURATION	ns typ	Ω typ	V min	pF max	FONCTION OPERATING	STOCKAGE STORAGE
EH 412	C 101	100	3.5	200	0.03	- 55 + 150	- 65 + 175
EH 533	C 100	5	3.5	40	0.03		

diodes snap-off step recovery diodes

CONDITIONS DE MESURES TEST CONDITIONS		+ 10 mA - 6 mA	+ 10 mA - 10 V		$I_R = 10 \mu\text{A}$	$V_R = 6 \text{ V}$ $f = 1 \text{ MHz}$	CONDITIONS LIMITES LIMITING CONDITIONS		
CARACTÉRISTIQUES A SPECIFICATIONS AT		$T = 25^\circ\text{C}$	τ_I	t_{so}	P_{diss}	V_{BR}	C_I	TEMPÉRATURES °C TEMPERATURES °C	
TYPE TYPE	BOITIER CASE	ns min	ps typ	ps max	W max	V min	pF max	FONCTION OPERATING	STOCKAGE STORAGE
DH 541	A 22 e	25	90	140	0.25	30	1.5		
DH 542	A 22 e	40	150	250	0.25	50	1.5		
DH 543	A 22 e	20	90	140	0.25	30	1	- 55 + 175	- 65 + 200
DH 544	A 22 e	35	150	250	0.25	50	1		
DH 551	F 27 d	15	70	100	1	20	1		
DH 552	F 27 d	20	90	140	1	30	1	- 55 + 175	- 65 + 200
DH 553	F 27 d	30	120	250	1	40	1		

varicaps abrupts au silicium silicon abrupt tuning diodes

CONDITIONS DE MESURES TEST CONDITIONS		$V_R = 4 \text{ V}$ $f = 1 \text{ MHz}$	$V_2 = V_{BR} \text{ min}$ $V_1 = 2 \text{ V}$ $f = 1 \text{ MHz}$	$V_R = 4 \text{ V}$ $f = 50 \text{ MHz}$	$I_R = 10 \mu\text{A}$	$V_R = 25 \text{ V}$	$V_R = - 4 \text{ V}$ $f = 1 \text{ MHz}$ $T \begin{cases} - 65^\circ\text{C} \\ + 85^\circ\text{C} \end{cases}$	CONDITIONS LIMITES LIMITING CONDITIONS	
CARACTÉRISTIQUES A SPECIFICATIONS AT		$T = 25^\circ\text{C}$	$C_T \pm 20\%$	C_{T1}/C_{T2}	Q	V_{BR}	I_R	α_C	TEMPÉRATURES °C TEMPERATURES °C
TYPE TYPE	BOITIER CASE	pF	typ	min	V min	μA max	$10^{-6}/^\circ\text{C}$ max	FONCTION OPERATING	STOCKAGE STORAGE
DH 7811 A	DO 7	6.8	2.7	800	30	0.02	400		
DH 7812 A	DO 7	8.2	2.8	800	30	0.02	400		
DH 7813 A	DO 7	10	2.8	750	30	0.02	400		
DH 7814 A	DO 7	12	2.8	750	30	0.02	400		
DH 7815 A	DO 7	15	2.8	750	30	0.02	400		
DH 7816 A	DO 7	18	2.8	700	30	0.02	400		
DH 7817 A	DO 7	20	2.8	700	30	0.02	400		
DH 7818 A	DO 7	22	2.9	700	30	0.02	400		
DH 7819 A	DO 7	27	2.9	700	30	0.02	400		
DH 7820 A	DO 7	33	2.9	700	30	0.02	400	- 55 + 100	- 65 + 150
DH 7821 A	DO 7	39	2.9	700	30	0.02	400		
DH 7822 A	DO 7	47	2.9	700	30	0.02	400		
DH 7823 A	DO 7	56	2.9	500	30	0.02	400		
DH 7824 A	DO 7	68	2.9	500	30	0.02	400		
DH 7825 A	DO 7	82	2.9	300	30	0.02	400		
DH 7826 A	DO 7	100	2.9	300	30	0.02	400		
DH 740	F 27 d	0.8	2.7	140*	40				
DH 741	F 27 d	1.2	2.8	135*	40				
DH 742	F 27 d	1.8	3	130*	40				
DH 743	F 27 d	2.7	3.2	120*	40				
DH 744	F 27 d	3.9	3.4	110*	40				
DH 745	F 27 d	4.7	3.9	100*	40				
DH 746	F 27 d	5.6	3.6	95*	40				
DH 747	F 27 d	6.8	3.7	90*	40			- 55 + 150	- 65 + 200
DH 790	F 27 d	0.8	1.8	195*	25				
DH 791	F 27 d	1.2	2	185*	25				
DH 792	F 27 d	1.8	2.1	180*	25				
DH 793	F 27 d	2.7	2.2	165*	25				
DH 794	F 27 d	3.9	2.3	130*	25				
DH 795	F 27 d	4.7	2.35	120*	25				

*f = 1 GHz

diodes de contrôle control diodes

varicaps hyperabrupts au silicium silicon hyperabrupt tuning diodes

CONDITIONS DE MESURES TEST CONDITIONS		$V_R = V_N$ $f = 1 \text{ MHz}$	$V_1 = 2 \text{ V}$ $V_2 = 20 \text{ V}$ $f = 1 \text{ MHz}$	$V_R = V_N$ $f = 50 \text{ MHz}$	$I_R = 10 \mu\text{A}$	CONDITIONS LIMITES LIMITING CONDITIONS					
CARACTÉRISTIQUES A SPECIFICATIONS AT		$T = 25^\circ\text{C}$	V_N	C_T	C_{T1}/C_{T2}	Q	γ	V_{BR}	TEMPÉRATURES °C TEMPERATURES °C		
TYPE TYPE	BOITIER CASE	V typ	pF min	pF max	min	min	pF min	pF max	V min	FONCTION OPERATING	STOCKAGE STORAGE
DH 724	DO 7	4	12	17	5	100	1	2	25	- 55 + 100	- 65 + 150
DH 726	DO 7	6	10	15	5	100	1	2	25		
DH 728	DO 7	8	9	14	5	150	1	2	25		
DH 730	DO 7	10	7	12	5	250	1	2	25		
DH 732	DO 7	12	7	12	5	250	1	2	25		
$f = 1 \text{ GHz}$											
DH 733	F 27 d	6	0.8		5	180	1		20	- 55 + 150	- 65 + 200
DH 734	F 27 d	6	1.2		5	160	1		20		
DH 735	F 27 d	6	1.8		5	150	1		20		
DH 736	F 27 d	6	2.7		6	100	1		20		
DH 737	F 27 d	6	3.9		6	85	1		20		
DH 738	F 27 d	6	4.7		6	70	1		20		

varicaps à l'arséniure de gallium gallium arsenide tuning diodes

CONDITIONS DE MESURES TEST CONDITIONS		$V_R = 0 \text{ V}$ $f = 1 \text{ MHz}$	$V_1 = 0 \text{ V}$ $f = 1 \text{ MHz}$	$V_R = 4 \text{ V}$ $f = 1 \text{ GHz}$	$I_R = 10 \mu\text{A}$	CONDITIONS LIMITES LIMITING CONDITIONS					
CARACTÉRISTIQUES A SPECIFICATIONS AT		$T = 25^\circ\text{C}$	$C_T \pm 20 \%$	C_{T1}/C_{T2}	Q	V_{BR}	TEMPÉRATURES °C TEMPERATURES °C				
TYPE TYPE	BOITIER CASE	pF typ	min	typ	V min	FONCTION OPERATING	STOCKAGE STORAGE				
$V_{R2} = 30 \text{ V}$											
AH 152	F 27 d	0.7	2.25	475	30	- 40 + 70	- 65 + 175				
AH 153	F 27 d	1	2.6	425	30						
AH 154	F 27 d	1.4	3	400	30						
AH 155	F 27 d	2.2	3.4	350	30						
AH 156	F 27 d	3	3.7	300	30						
$V_{R2} = 40 \text{ V}$											
AH 160	F 27 d	0.7	2.35	450	45	- 40 + 70	- 65 + 175				
AH 161	F 54	1	2.7	375	45						
AH 162	M 208 b	1.4	3.1	350	45						
AH 163	W 2	2.2	3.7	300	45						
AH 164	W 2	3	4	250	45						
$V_{R2} = 55 \text{ V}$											
AH 165	W 2	0.7	2.45	350	60	- 40 + 70	- 65 + 175				
AH 166	W 2	1	2.9	325	60						
AH 167	W 2	1.4	3.4	300	60						
AH 168	W 2	2.2	4	250	60						
AH 169	W 2	3	4.3	200	60						

varicaps abrupts au silicium, en microéléments silicon abrupt tuning diodes, microcomponents

CONDITIONS DE MESURES TEST CONDITIONS		$V_R = 4 \text{ V}$ $f = 1 \text{ GHz}$	$V_1 = 2 \text{ V}$ $V_2 = V_{BR} \text{ min}$ $f = 1 \text{ MHz}$	$V_R = 4 \text{ V}$ $f = 1 \text{ GHz}$	$I_R = 10 \mu\text{A}$	CONDITIONS LIMITES LIMITING CONDITIONS		
CARACTÉRISTIQUES A SPECIFICATIONS AT		$T = 25^\circ\text{C}$	$C_T \pm 20 \%$	C_{T1}/C_{T2}	Q	V_{BR}	TEMPÉRATURES °C TEMPERATURES °C	
TYPE TYPE	PRÉSENTATION CONFIGURATION	pF typ	min	min	V min	FONCTION OPERATING	STOCKAGE STORAGE	
EH 740	C2	0.6	3.5	140	40	- 55 + 150	- 65 + 200	
EH 741	C2	1	3.8	135	40			
EH 742	C2	1.6	4.1	130	40			
EH 790	C2	0.6	3	195	25			
EH 791	C2	1	3.3	185	25			
EH 792	C2	1.6	3.6	180	25			

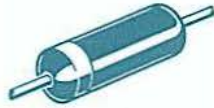

D07

F 27d

F 54

M 208b

W2

varicaps hyperabrupts au silicium, en microéléments silicon hyperabrupt tuning diodes, microcomponents

CONDITIONS DE MESURES TEST CONDITIONS		$V_R = V_N$ $f = 1 \text{ MHz}$		$V_1 = 2 \text{ V}$ $V_2 = 20 \text{ V}$ $f = 1 \text{ MHz}$		$V_R = V_N$ $f = 1 \text{ GHz}$		$I_R = 10 \mu\text{A}$		CONDITIONS LIMITES LIMITING CONDITIONS
CARACTÉRISTIQUES A SPECIFICATIONS AT		$T = 25 \text{ }^\circ\text{C}$	$V_N (\pm 1 \text{ V})$	$C_T \pm 20 \%$		C_{T1}/C_{T2}	Q	V_{BR}	TEMPÉRATURES $^\circ\text{C}$ TEMPERATURES $^\circ\text{C}$	
TYPE TYPE	PRÉSENTATION CONFIGURATION	V typ	pF typ	min		min	min	V min	FONCTION OPERATING	STOCKAGE STORAGE
EH 733	C2	6	0.6	5		180	20			
EH 734	C2	6	1	5		160	20		- 55 + 150	- 65 + 200
EH 735	C2	6	1.6	5		150	20			

diodes schottky de commutation schottky switching diodes

CONDITIONS DE MESURES TEST CONDITIONS		$V_M = 3 \text{ V}_p$ $f = 100 \text{ MHz}$	$I_R = 10 \mu\text{A}$	$V_R = -5 \text{ V}$	$V_R = 0 \text{ V}$ $f = 1 \text{ MHz}$	$I_F = 1 \text{ mA}$	$I_F = 50 \text{ mA}$	CONDITIONS LIMITES LIMITING CONDITIONS		
CARACTÉRISTIQUES A SPECIFICATIONS AT		$T = 25 \text{ }^\circ\text{C}$	τ_I	V_{BR}	I_R	C_T	V_F	V_F	TEMPÉRATURES $^\circ\text{C}$ TEMPERATURES $^\circ\text{C}$	
TYPE TYPE	BOITIER CASE	ps max	V min	nA typ	nA max	pF max	V max	V max	FONCTION OPERATING	STOCKAGE STORAGE
DH 501	A 22 e	60	10	10	50	1	0.6	1	- 40 + 100	- 40 + 125
DH 502	A 22 e	60	15	2	20	1	0.6	1		
DH 511	A 22 e	80	15	90	250	1	0.6	1		
DH 512	A 22 e	80	20	70	200	1	0.6	1		
DH 513	A 22 e	80	25	50	150	1	0.6	1	- 55 + 150	- 65 + 175
DH 514	A 22 e	80	30	30	100	1	0.6	1		

diodes schottky de commutation, en microéléments schottky switching diodes, microcomponents

CONDITIONS DE MESURES TEST CONDITIONS		$V_M = 3 \text{ V}_p$ $f = 100 \text{ MHz}$	$I_R = 10 \mu\text{A}$	$V_R = -5 \text{ V}$	$V_R = 0 \text{ V}$ $f = 1 \text{ MHz}$	CONDITIONS LIMITES LIMITING CONDITIONS		
CARACTÉRISTIQUES A SPECIFICATIONS AT		$T = 25 \text{ }^\circ\text{C}$	τ_I	V_{BR}	I_R	C_I	TEMPÉRATURES $^\circ\text{C}$ TEMPERATURES $^\circ\text{C}$	
TYPE TYPE	PRÉSENTATION CONFIGURATION	ps max	V min	nA typ	pF max	FONCTION OPERATING	STOCKAGE STORAGE	
EH 511	C2	80	15	90	0.9			
EH 512	C2	80	20	70	0.9			
EH 513	C2	80	25	50	0.9	- 55 + 150	- 65 + 175	
EH 514	C2	80	30	30	0.9			

varactors limiteurs limiter varactors

CONDITIONS DE MESURES TEST CONDITIONS		$I_R = 10 \mu\text{A}$	$V_R = 6 \text{ V}$ $f = 1 \text{ MHz}$	$V_R = 6 \text{ V}$ $f = 2.75 \text{ GHz}$	CONDITIONS LIMITES LIMITING CONDITIONS						
CARACTÉRISTIQUES A SPECIFICATIONS AT		$T = 25 \text{ }^\circ\text{C}$	V_{BR}	C_I	f_c	R_{th}	P_{diss}	TEMPÉRATURES $^\circ\text{C}$ TEMPERATURES $^\circ\text{C}$			
TYPE TYPE	BOITIER CASE	FREQUENCE MAX MAX FREQUENCY GHz	V min	V max	pF min	pF max	GHz min	$^\circ\text{C/W}$ max	W max	FONCTION OPERATING	STOCKAGE STORAGE
DH 601	F 27 d	6	30	45	0.2	0.5	150	90	0.75		
DH 602	F 27 d	6	30	45	0.2	0.5	200	90	0.75		
DH 603	F 27 d	8	60	90	0.2	0.5	80	70	1		
DH 604	F 27 d	8	60	90	0.2	0.5	150	70	1	- 55 + 150	- 65 + 175
DH 605	F 27 d	10	90	120	0.2	0.5	100	50	1.5		
DH 606	F 27 d	12	120	150	0.2	0.5	100	40	2		

diodes de contrôle control diodes



F 27d

varactors limiteurs rapides fast limiter varactors

CONDITIONS DE MESURES TEST CONDITIONS		$I_R = 10 \mu A$	$V_R = 0 V$ $f = 1 MHz$	$V_R = 0 V$ $f = 2.75 GHz$	CONDITIONS LIMITES LIMITING CONDITIONS					
CARACTÉRISTIQUES A SPECIFICATIONS AT		$T = 25 ^\circ C$	V_{BR}	C_j	f_c	R_{th}	$P_{diss.}$	TEMPÉRATURES $^\circ C$ TEMPERATURES $^\circ C$		
TYPE TYPE	BOITIER CASE	FREQUENCE MAX MAX FREQUENCY GHz	V min	pF min	pF max	GHz min	$^\circ C/W$ max	W max	FONCTION OPERATING	STOCKAGE STORAGE
DH 622	F 27 d	2-6	25	0.2	0.3	85	90	0.75		
DH 623	F 27 d	2-12	25	0.2	0.3	100	90	0.75	- 55 + 150	- 65 + 175
DH 624	F 27 d	12	25	0.2	0.3	140	90	0.75		
DH 625	F 27 d	16	25	0.1	0.2	180	150	0.5		

varactors limiteurs en microéléments limiter varactors, microcomponents

CONDITIONS DE MESURES TEST CONDITIONS		$I_R = 10 \mu A$	$V_R = 0 V$ $f = 1 MHz$	$V_R = 0 V$ $f = 2.75 GHz$	CONDITIONS LIMITES LIMITING CONDITIONS		
CARACTÉRISTIQUES A SPECIFICATIONS AT		$T = 25 ^\circ C$	V_{BR}	C_j	f_c	TEMPÉRATURES $^\circ C$ TEMPERATURES $^\circ C$	
TYPE TYPE	PRÉSENTATION CONFIGURATION	V min	pF min	pF max	GHz min	FONCTION OPERATING	STOCKAGE STORAGE
EH 624	C2	25	0.2	0.3	140	- 55 + 150	- 65 + 175
EH 625	C2	25	0.1	0.2	180		

varactors de commutation switching varactors

CONDITIONS DE MESURES TEST CONDITIONS		10 mA - 6 mA	+ 10 mA - 10 V	$I_R = 10 \mu A$	$V_R = 6 V$ $f = 1 MHz$	CONDITIONS LIMITES LIMITING CONDITIONS		
CARACTÉRISTIQUES A SPECIFICATIONS AT		$T = 25 ^\circ C$	τ_f	t_{so}	V_{BR}	C_j	TEMPÉRATURES $^\circ C$ TEMPERATURES $^\circ C$	
TYPE TYPE	PRÉSENTATION CONFIGURATION	ns typ	ps typ	V min	pF min	pF max	FONCTION OPERATING	STOCKAGE STORAGE
EH 255	C2	40	120	40	0.8	1.4		
EH 256	C2	20	90	30	0.5	0.8	- 65 + 175	- 65 + 200
EH 257	C2	15	80	25	0.3	0.5		
EH 258	C2	10	70	20	0.15	0.3		

diodes de réception receiving diodes



P 3



P 3a



P 3c

diodes cristaux mélangeurs mixer diodes

CONDITIONS DE MESURES TEST CONDITIONS		PRÉAMPLIFICATEUR I.F. AMPLIFIER FRÉQUENCE INT. I.F. FREQUENCY PUISSANCE O.L. L.O. POWER		NF = 1.5 dB 30 MHz 1 mW		RÉSISTANCE DE CHARGE CONT. D.C. LOAD RESISTANCE CHARGE MOYEN. FRÉQ. I.F. LOAD RESISTANCE		100 Ω 400 Ω 3 ns	
CARACTÉRISTIQUES A SPECIFICATIONS AT		T = 25 °C		N F ₀	R O S V.S.W.R.	Z _{if}	FRÉQUENCE DE MESURES TEST FREQUENCY	ESSAI DE SURCHARGE TEST PULSE ENERGY	
TYPE TYPE	BOITIER CASE	FRÉQUENCE FREQUENCY GHz	dB max		max	Ω min	Ω max	GHz	Erg
1N 21 C	P 3	2 - 6	8.3					3.06	2
1N 21 CR	P3	2 - 6	8.3					3.06	2
1N 21 D	P3	2 - 6	7.3		1.5	325	475	3.06	2
1N 21 DR	P 3	2 - 6	8.3					3.06	2
1N 416 C	P 3	2 - 6	7.3		1.5	325	475	3.06	2
1N 416 D	P 3a	2 - 6	7.3		1.5	325	475	3.06	2
1N 23 C	P 3	6 - 12	9.5		1.5	325	475	9.375	1
1N 23 CR	P 3	6 - 12	9.5		1.5	325	475	9.375	1
1N 415 C	P 3a	6 - 12	9.5		1.5	325	475	9.375	1
1N 149	P 3	6 - 12	8.3		1.5	325	475	9.375	1
1N 149 R	P 3	6 - 12	8.3		1.5	325	475	9.375	1
1N 23 D	P 3	6 - 12	8.2		1.3	350	450	9.375	1
1N 23 DR	P 3	6 - 12	8.2		1.3	350	450	9.375	1
1N 415 D	P 3a	6 - 12	8.2		1.3	350	450	9.375	1
1N 23 E	P 3	6 - 12	7.5		1.3	335	465	9.375	1
1N 23 ER	P 3	6 - 12	7.5		1.3	335	465	9.375	1
1N 415 E	P 3a	6 - 12	7.5		1.3	335	465	9.375	1
TH 8021 C	P 3c	2 - 6	8.3		2	200	800	3.06	2
TH 8121 C	P 3c	2 - 6	8.3		2	200	800	3.06	2
TH 8021 D	P 3c	2 - 6	7.3		1.5	325	475	3.06	2
TH 8121 D	P 3c	2 - 6	7.3		1.5	325	475	3.06	2
TH 8023 C	P 3c	6 - 12	9.5		1.5	200	500	9.375	1
TH 8123 C	P 3c	6 - 12	9.5		1.5	200	500	9.375	1
TH 8049	P 3c	6 - 12	8.3		1.5	325	475	9.375	1
TH 8149	P 3c	6 - 12	8.3		1.5	325	475	9.375	1
TH 8249	P 3a	6 - 12	8.3		1.5	325	475	9.375	1
TH 8023 D	P 3c	6 - 12	8.2		1.3	350	450	9.375	1
TH 8123 D	P 3c	6 - 12	8.2		1.3	350	450	9.375	1
TH 8023 E	P 3c	6 - 12	7.5		1.3	335	465	9.375	1
TH 8123 E	P 3c	6 - 12	7.5		1.3	335	465	9.375	1

diodes cristaux détecteurs detector diodes

CONDITIONS DE MESURES TEST CONDITIONS		BANDE VIDÉO VIDEO BANDWIDTH : 1 MHz POLAR. NULLE ZERO BIAS DÉTECTEUR ADAPTÉ R.F. MATCHING		V _F = 5 mV		R _A = 1200 Ω P _{LO} = 5 μW			
CARACTÉRISTIQUES A SPECIFICATIONS AT		T = 25 °C		T _{SS}	R _V	M	FRÉQUENCE DE MESURE TEST FREQUENCY		
TYPE TYPE	BOITIER CASE	FRÉQUENCE FREQUENCY GHz	typ dBm		kΩ min	kΩ max	min	GHz	
1N 32	P 3	2 - 6	- 54		5	25	100	3.06	
1N 32 R	P 3	2 - 6	- 54		5	25	100	3.06	
1N 2102	P 3a	2 - 6	- 54		5	25	100	3.06	
1N 31	P 3	6 - 12	- 47		5	25	55	9.375	
1N 31 R	P 3	6 - 12	- 47		5	25	55	9.375	
TH 8032	P 3c	2 - 6	- 54		5	25	100	3.06	
TH 8132	P 3c	2 - 6	- 54		5	25	100	3.06	
TH 8031	P 3c	6 - 12	- 47		5	25	55	9.375	
TH 8131	P 3c	6 - 12	- 47		5	25	55	9.375	
TH 8231	P 3a	6 - 12	- 47		5	25	55	9.375	

diodes de réception receiving diodes

diodes schottky mélangeuses schottky mixer diodes

CONDITIONS DE MESURES TEST CONDITIONS		N.F. PRÉAMPLIFICATEUR N.F. I.F. AMPLIFIER : 1.5 dB FRÉQUENCE INTERMÉDIAIRE : 30 MHz I.F. FREQUENCY PUISSANCE O.L. : 1 mW L.O. POWER				CHARGE MOYENNE FRÉQUENCE : 400 Ω I.F. LOAD RESISTANCE RÉSISTANCE DE CHARGE CONT. : 100 Ω D.C. LOAD RESISTANCE TUBE DE BRUIT : 15.6 dB NOISE TUBE : 3 ns				CONDITIONS LIMITES LIMITING CONDITIONS					
CARACTÉRISTIQUES A SPECIFICATIONS AT		T = 25 °C		N F ₀		R.O.S V.S.W.R		Z _{if}		FRÉQUENCE DE MESURE TEST FREQUENCY		ESSAI DE SURCHARGE TEST PULSE ENERGY		TEMPÉRATURES °C TEMPERATURES °C	
TYPE TYPE	BOITIER CASE	BANDE DE FRÉQUENCE FREQUENCY RANGE GHz		dB max	typ	max	Ω min	Ω max	GHz	Erg	FONCTION. OPERATING		STOCKAGE STORAGE		
DH 309 D	P 3a	2 - 6		7.5	1.5	2	300	500	3.06	5					
DH 309 E	P 3a	2 - 6		7	1.5	2	300	500	3.06	5					
DH 309 F	P 3a	2 - 6		6	1.5	2	300	500	3.06	5					
DH 309 G	P 3a	2 - 6		5.5	1.5	2	300	500	3.06	5					
DH 319 D	P 3a	6 - 12		8	1.5	2	300	500	9.375	5	- 55 + 150		- 65 + 175		
DH 319 E	P 3a	6 - 12		7.5	1.5	2	300	500	9.375	5					
DH 319 F	P 3a	6 - 12		7	1.5	2	300	500	9.375	5					
DH 319 G	P 3a	6 - 12		6.5	1.5	2	300	500	9.375	5					
DH 319 H	P 3a	6 - 12		6	1.5	2	300	500	9.375	5					

diodes schottky mélangeuses schottky mixer diodes

CONDITIONS DE MESURES TEST CONDITIONS		N.F. PRÉAMPLIFICATEUR : 1.5 dB N.F. I.F. AMPLIFIER FRÉQUENCE INTERMÉDIAIRE : 3 MHz I.F. FREQUENCY PUISSANCE O.L. : 1 mW L.O. POWER				RÉSISTANCE DE CHARGE CONT. : 10 Ω D.C. LOAD RESISTANCE TUBE DE BRUIT : 15.6 dB NOISE TUBE : 3 ns				CONDITIONS LIMITES LIMITING CONDITIONS							
CARACTÉRISTIQUES A SPECIFICATIONS AT		T = 25 °C		N F ₀		R.O.S V.S.W.R		Z _{if}		FRÉQUENCE DE MESURE TEST FREQUENCY		ESSAI DE SURCHARGE TEST PULSE ENERGY		TEMPÉRATURES °C TEMPERATURES °C			
TYPE TYPE	BOITIER CASE	FRÉQUENCE FREQUENCY GHz		dB max	typ	max	Ω min	Ω max	GHz	Erg	P _{rfmax} mW max	I _F mA max	V _R V	FONCTION. OPERATING		STOCKAGE STORAGE	
DH 301	F 51	1 - 6		6.5	1.5	2	200	400	3.06	5	250	50	3				
DH 302	F 51	1 - 6		6	1.5	2	200	400	3.06	5	250	50	3				
DH 303	F 51	1 - 6		5.5	1.5	2	200	400	3.06	5	250	50	3				
DH 312	F 51	6 - 12		7	1.5	2	200	400	9.375	5	250	50	3				
DH 313	F 51	6 - 12		6.5	1.5	2	200	400	9.375	5	250	50	3				
DH 314	F 51	6 - 12		6	1.5	2	200	400	9.375	5	250	50	3	- 55 + 150		- 65 + 175	
DH 315	F 51	6 - 12		5.5	1.5	2	200	400	9.375	5	250	50	3				
DH 322	F 51	12 - 18		7.5	1.5	2	200	400	15	5	250	50	3				
DH 323	F 51	12 - 18		7	1.5	2	200	400	15	5	250	50	3				
DH 324	F 51	12 - 18		6.5	1.5	2	200	400	15	5	250	50	3				
DH 325	F 51	12 - 18		6	1.5	2	200	400	15	5	250	50	3				

à seuil moyen - medium barrier

DH 301	F 51	1 - 6		6.5	1.5	2	200	400	3.06	5	250	50	3				
DH 302	F 51	1 - 6		6	1.5	2	200	400	3.06	5	250	50	3				
DH 303	F 51	1 - 6		5.5	1.5	2	200	400	3.06	5	250	50	3				
DH 312	F 51	6 - 12		7	1.5	2	200	400	9.375	5	250	50	3				
DH 313	F 51	6 - 12		6.5	1.5	2	200	400	9.375	5	250	50	3				
DH 314	F 51	6 - 12		6	1.5	2	200	400	9.375	5	250	50	3	- 55 + 150		- 65 + 175	
DH 315	F 51	6 - 12		5.5	1.5	2	200	400	9.375	5	250	50	3				
DH 322	F 51	12 - 18		7.5	1.5	2	200	400	15	5	250	50	3				
DH 323	F 51	12 - 18		7	1.5	2	200	400	15	5	250	50	3				
DH 324	F 51	12 - 18		6.5	1.5	2	200	400	15	5	250	50	3				
DH 325	F 51	12 - 18		6	1.5	2	200	400	15	5	250	50	3				

à fort seuil - high barrier

DH 351	F 51	1 - 6		6.5	1.5	2	200	400	3.06	5	250	50	3				
DH 352	F 51	1 - 6		6.5	1.5	2	200	400	3.06	5	250	50	3				
DH 353	F 51	1 - 6		5.5	1.5	2	200	400	3.06	5	250	50	3				
DH 362	F 51	6 - 12		7	1.5	2	200	400	9.375	5	250	50	3				
DH 363	F 51	6 - 12		6.5	1.5	2	200	400	9.375	5	250	50	3				
DH 364	F 51	6 - 12		6	1.5	2	200	400	9.375	5	250	50	3	- 55 + 100		- 65 + 125	
DH 365	F 51	6 - 12		5.5	1.5	2	200	400	9.375	5	250	50	3				
DH 372	F 51	12 - 18		7.5	1.5	2	200	400	15	5	250	50	3				
DH 373	F 51	12 - 18		7	1.5	2	200	400	15	5	250	50	3				
DH 374	F 51	12 - 18		6.5	1.5	2	200	400	15	5	250	50	3				
DH 375	F 51	12 - 18		6	1.5	2	200	400	15	5	250	50	3				



P 3a

F 51

M 208b

BH 4

diodes schottky mélangeuses à faible bruit au Ga As GaAs low noise schottky mixer diodes

CONDITIONS DE MESURES TEST CONDITIONS		N.F. PRÉAMPLIFICATEUR N.F. I.F. AMPLIFIER : 1.5 dB FRÉQUENCE INTERMÉDIAIRE I.F. FREQUENCY : 30 MHz PUISSANCE O.L. L.O. POWER : 1 mW RÉSISTANCE DE CHARGE CONT. D.C. LOAD RESISTANCE : 10 Ω TUBE DE BRUIT NOISE TUBE : 15.6 dB					CONDITIONS LIMITES LIMITING CONDITIONS			
CARACTÉRISTIQUES A SPECIFICATIONS AT T = 25 °C		N F ₀	R.O.S. V.S.W.R.	Z _{if}	FRÉQUENCE DE MESURE TEST FREQUENCY	I _F	TEMPÉRATURES °C TEMPERATURES °C			
TYPE TYPE	BOITIER CASE	BANDE DE FRÉQUENCE RANGE GHz	dB max	typ	Ω min	Ω max	GHz	mA max	FONCTION. OPERATING	STOCKAGE STORAGE
DH 378	F 51	8 - 12	5.5	2	200	500	9.375	30		
DH 379	F 51	12 - 18	5.5	2	200	500	14.3	30		
DH 383	M 208b	18 - 40	7	3	200	500	25.5	30	- 40 + 70	- 65 + 150
DH 384	BH 4	18 - 40	6.5	3	200	500	25.5	30		
DH 385	BH 4	18 - 40	6	3	200	500	25.5	30		

diodes schottky mélangeuses en microéléments schottky mixer diodes, microcomponents

CONDITIONS DE MESURES TEST CONDITIONS		V = 0 V f = 1 MHz		I _F = 10 mA	P _{L0} = 1 mW I _F = 30 MHz	CONDITIONS LIMITES LIMITING CONDITIONS		
CARACTÉRISTIQUES A SPECIFICATIONS AT T = 25 °C		C _j		V _F	N.F. ₀	TEMPÉRATURES °C TEMPERATURES °C		
TYPE TYPE	PRÉSENTATION CONFIGURATION	FRÉQUENCE FREQUENCY	pF min	pF max	V typ	dB max	FONCTION. OPERATING	STOCKAGE STORAGE
EH 305	C1	1 - 4	0.3	0.35	0.4	5.5		
EH 315	C1	4 - 8	0.17	0.22	0.42	5.5		
EH 317	C1	6 - 12	0.13	0.18	0.43	6	- 55 + 150	- 65 + 175
EH 318	C1	8 - 15	0.12	0.14	0.45	6		
EH 320	C1	12 - 18	0.07	0.10	0.47	6.5		

diodes schottky détectrices schottky detector diodes

CONDITIONS DE MESURES TEST CONDITIONS		BANDE VIDEO : 1 MHz VIDEO BANDWIDTH COURANT DE POLAR. : 30 μA BIAS CURRENT					CONDITIONS LIMITES LIMITING CONDITIONS			
CARACTÉRISTIQUES A SPECIFICATIONS AT T = 25 °C		T _{ss}	R _v		P _{rlmax}	I _F	V _R	TEMPÉRATURES °C TEMPERATURES °C		
TYPE TYPE	BOITIER CASE	BANDE DE FRÉQUENCE RANGE GHz	dBm typ	K Ω min	K Ω max	mW max	mA max	V	FONCTION. OPERATING	STOCKAGE STORAGE
DH 340	F 51	2 - 12	- 54	1	2	250	50	3		
DH 340	F 51	12 - 18	- 51	1	2	250	50	3		
DH 309	P 3a	2 - 6	- 55	1	2	250	50	3	- 55 + 150	- 65 + 150
DH 319	P 3a	6 - 12	- 52	1	2	250	50	3		

diodes d'émission emitting diodes

diodes Gunn Gunn diodes

CARACTÉRISTIQUES A SPECIFICATION AT			POLARISATION BIAS TENSION VOLTAGE		COURANT CURRENT		P _O	TEMPÉRATURES °C TEMPERATURES °C	
TYPE TYPE	BOITIER CASE	FREQUENCE FREQUENCY GHz	V min	V max	mA typ	mA max	mW min	FONCTION. OPERATING	STOCKAGE STORAGE
AH 411	F 27 d - W2	5.5 - 6	10	13	450	600	100		
AH 414	F 27 d - W2	5.5 - 6	10	14	500	700	200		
AH 417	F 27 d - W2	5.5 - 6	10	14	700	900	300		
AH 412	F 27 d - W2	6 - 7	10	13	450	600	100		
AH 415	F 27 d - W2	6 - 7	10	14	500	700	200		
AH 418	F 27 d - W2	6 - 7	10	14	700	900	300		
AH 413	F 27 d - W2	7 - 8	10	13	450	600	100		
AH 416	F 27 d - W2	7 - 8	10	14	500	700	200		
AH 419	F 27 d - W2	7 - 8	10	14	700	900	300		
AH 443	W2	8 - 9	8	11	500	650	100		
AH 447	W2	8 - 9	9	12	600	850	200		
AH 451	W2	8 - 9	9	13	800	950	300		
AH 444	W2	9 - 10	8	11	500	650	100		
AH 448	W2	9 - 10	9	12	600	850	200		
AH 452	W2	9 - 10	9	13	800	950	300		
AH 445	W2	10 - 11	8	11	500	650	100		
AH 449	W2	10 - 11	9	12	600	850	200		
AH 453	W2	10 - 11	9	13	800	950	300		
AH 446	W2	11 - 12	8	11	500	650	100		
AH 450	W2	11 - 12	9	12	600	850	200		
AH 454	W2	11 - 12	9	13	800	950	300		
AH 479	W2	12 - 13.5	7	9	550	700	100		
AH 483	W2	12 - 13.5	7	9	700	900	150		
AH 487	W2	12 - 13.5	7	10	700	900	200		
AH 480	W2	13.5 - 15	7	9	550	700	100		
AH 484	W2	13.5 - 15	7	9	700	900	150		
AH 488	W2	13.5 - 15	7	10	700	900	200		
AH 481	W2	15 - 16.5	7	9	550	700	100		
AH 485	W2	15 - 16.5	7	9	700	900	150		
AH 489	W2	15 - 16.5	7	10	700	900	200		
AH 482	W2	16.5 - 18	7	9	550	700	100		
AH 486	W2	16.5 - 18	7	9	700	900	150		
AH 490	W2	16.5 - 18	7	10	700	900	200		
AH 365	W2	18 - 20	4	8	400	650	50		
AH 369	W2	18 - 20	4	8	500	1000	100		
AH 366	W2	20 - 22	4	8	400	650	50		
AH 370	W2	20 - 22	4	8	500	1000	100		
AH 367	W2	22 - 24	4	8	400	650	50		
AH 371	W2	22 - 24	4	8	500	1000	100		
AH 368	W2	24 - 26	4	8	400	650	50		
AH 372	W2	24 - 26	4	8	500	1000	100		
AH 601	W2 - W3	26 - 28	4	8	600	800	50		
AH 606	W2 - W3	26 - 28	4	8	1000	1200	100		
AH 611	W2 - W3	26 - 28	4	8	1200	1400	150		
AH 602	W2 - W3	28 - 31	4	8	600	800	50		
AH 607	W2 - W3	28 - 31	4	8	1000	1200	100		
AH 612	W2 - W3	28 - 31	4	8	1200	1400	150		
AH 603	W2 - W3	31 - 34	4	8	600	800	50		
AH 608	W2 - W3	31 - 34	4	8	1000	1200	100		
AH 613	W2 - W3	31 - 34	4	8	1200	1400	150		
AH 604	W2 - W3	34 - 37	4	8	600	800	50		
AH 609	W2 - W3	34 - 37	4	8	1000	1200	100		
AH 614	W2 - W3	34 - 37	4	8	1200	1400	150		
AH 605	W3	37 - 40	4	8	600	800	50		
AH 610	W3	37 - 40	4	8	1000	1200	100		
AH 615	W3	37 - 40	4	8	1200	1400	150		

— 40 + 70 — 65 + 175



F 27d



W 2



W 3



W1 (S 268)

diodes Gunn en impulsions pulsed Gunn diodes

CARACTÉRISTIQUES A SPECIFICATIONS AT			Polarisation BIAS		P _O CRÊTE PEAK	FACTEUR D'UTILISATION DUTY CYCLE	LARGEUR IMPULSION PULSE LENGTH	TEMPÉRATURES °C TEMPERATURES °C	
TYPE TYPE	BOITIER CASE	FREQUENCE FREQUENCY GHz	TENSION CRÊTE PEAK VOLTAGE	COURANT CRÊTE PEAK CURRENT	W min	%	µs	FONCTION OPERATING	STOCKAGE STORAGE
AH 677	F 27 d	12.4 - 18	25	5	5	1	1	- 40 + 70	- 65 + 175

diodes à avalanche au silicium silicon impatt diodes

CARACTÉRISTIQUES A SPECIFICATIONS AT			Polarisation BIAS		COURANT CURRENT		P _O	R _{th}	TEMPÉRATURES °C TEMPERATURES °C	
TYPE TYPE	BOITIER CASE	FREQUENCE FREQUENCY GHz	V min	V max	mA typ	mA max	mW min	°C/W max	FONCTION OPERATING	STOCKAGE STORAGE
AH 224 R	F 27 d	6 - 7	95	130	80	100	500	25		
AH 225 R	F 27 d	7 - 8	95	130	80	100	500	25		
AH 259 R	F 27 d	8 - 9	85	110	80	100	500	25		
AH 260 R	F 27 d	9 - 10	85	110	80	100	500	25		
AH 261 R	F 27 d	10 - 11	85	110	80	100	500	25		
AH 262 R	F 27 d	11 - 12	85	110	80	100	500	25		
AH 291 R	F 27 d - W2	12 - 13.5	60	90	75	100	350	30		
AH 292 R	F 27 d - W2	13.5 - 15	60	90	75	100	350	30		
AH 293 R	F 27 d - W2	15 - 16.5	60	90	75	100	350	30		
AH 294 R	F 27 d - W2	16.5 - 18	60	90	75	100	350	30	- 40 + 70	- 65 + 200
AH 347 R	F 27 d - W2	18 - 20	50	80	60	80	200	35		
AH 348 R	F 27 d - W2	20 - 22	50	80	60	80	200	35		
AH 349 R	F 27 d - W2	22 - 24	50	80	60	80	200	35		
AH 350 R	F 27 d - W2	24 - 27	45	75	65	90	200	35		
AH 326 R (1)	W2	27 - 30	40	65	100	150	300	30		
AH 327 R (1)	W2	30 - 32	40	65	100	150	300	30		
AH 328 R (1)	W2	33 - 36	30	60	150	200	300	30		
AH 329 R (1)	W2	36 - 39	30	60	150	200	300	30		
AH 330 R (1)	W2	30 - 42	25	155	160	220	300	30		

forte puissance high power

AH 512	W1 - S 268	6 - 7	100	130	100	130	1000	13		
AH 513	W1 - S 268	6 - 7	110	140	130	160	1500	11		
AH 518	W1 - S 268	7 - 8	100	130	100	130	1000	13		
AH 519	W1 - S 268	7 - 8	110	140	130	160	1500	11		
AH 543	W1 - S 268	8 - 9	85	115	130	160	1000	12		
AH 544	W1 - S 268	9 - 10	85	115	130	160	1000	12		
AH 545	W1 - S 268	10 - 11	85	115	130	160	1000	12		
AH 546	W1 - S 268	11 - 12	85	115	130	160	1000	12	- 40 + 70	- 65 + 200
AH 573	W1 - S 268	12 - 13.5	60	85	100	130	500	20		
AH 579	W1 - S 268	12 - 13.5	70	100	110	150	750	17		
AH 574	W1 - S 268	13.5 - 15	60	85	100	130	500	20		
AH 580	W1 - S 268	13.5 - 15	70	100	110	150	750	17		
AH 575	W1 - S 268	15 - 16.5	60	85	100	130	500	20		
AH 581	W1 - S 268	15 - 16.5	70	100	110	150	750	17		

(1) Double drift
Double drift

transistors à effet de champ
field effect transistors



transistors à effet de champ

field effect transistors

La Division Composants Microonde de THOMSON-CSF a développé une gamme de transistors à effet de champ sur arséniure de gallium (TEC Ga As) pour les applications de 4 à 15 GHz.

Les pages suivantes regroupent les caractéristiques générales des trois familles disponibles en boîtiers hermétiques :

- Les TEC moyenne et forte puissance, délivrent 1 W à 8,5 GHz et 150 mW à 12 GHz. Trois dispositifs nouveaux TC 5251, TC 5250 et TC 4250 sont livrés en boîtiers préadaptés en entrée et permettent une réalisation aisée d'amplificateurs de puissance dans la bande de fréquence de 7,7 à 8,5 GHz (télécommunications).

- Les TEC faible bruit offrent des facteurs de bruit de 1,5 à 2,5 dB entre 4 et 10 GHz. Le TC 1101 grâce à sa grande largeur de grille présente en outre une faible intermodulation de 3^e ordre.

- Les TEC Autopolarisés et Préadaptés (TECAP), possèdent des réseaux d'adaptation en entrée et sortie et sont équipés d'un circuit d'autopolarisation. Ils permettent de réaliser simplement, par mise en cascade, des amplificateurs de gain élevé. Les puissances de sortie varient de 40 à 100 mW. Ils sont disponibles dans les bandes de fréquences radars et télécommunications entre 8,5 et 14,5 GHz.

THOMSON-CSF Microwave Component Division has developed a range of gallium arsenide field effect transistors (GaAs FETs) for 4 to 15 GHz applications.

The leading characteristics of the three families available in hermetically sealed cases are listed in the following pages.

- Medium and high power FETs supply 1 W at 8.5 GHz and 150 mW at 12 GHz. Three new devices, TC 5251, TC 5250 and TC 4250 are supplied in cases with matched inputs and make it easy to build up power amplifiers in the 7.7 to 8.5 GHz frequency range (telecommunications).

- Low noise FETs present noise figure from 1.5 dB to 2.5 dB between 4 and 10 GHz. Moreover, due to its wide gate, the TC 1101 presents a low 3rd order intermodulation.

- Selfbiased and matched FETs (TECAP), are provided with an input and output matching network and fitted with a selfbiasing circuit. By cascading they make it very easy to build up high gain amplifiers. Output powers vary from 40 to 100 mW. They are available in the telecommunications and radars frequency bands between 8.5 and 14.5 GHz.

symboles

N.F.	FACTEUR DE BRUIT
G_p	GAIN EN PUISSANCE
G_p (N.F. min)	GAIN EN PUISSANCE A L'OPTIMUM DE BRUIT
I_{DSS}	COURANT DE DRAIN POUR UNE TENSION GRILLE-SOURCE NULLE
I_{DS}	COURANT DE DRAIN
V_{GS}	TENSION GRILLE-SOURCE
V_{GS0}	TENSION DE BLOCAGE
V_{BRGSS}	TENSION DE CLAQUAGE GRILLE-SOURCE ($V_{DS} = 0$)
gm	TRANSCONDUCTANCE
P_O	PUISSANCE DE SORTIE
P_{O1}	PUISSANCE DE SORTIE A - 1 dB DE COMPRESSION DU GAIN
R.O.S. V.S.W.R.	RAPPORT D'ONDE STATIONNAIRE

symbols

NOISE FIGURE
POWER GAIN
POWER GAIN AT MINIMUM NOISE FIGURE
SATURATED DRAIN CURRENT. THE DRAIN CURRENT FOR A SPECIFIED VALUE OF V_{DS} WHEN $V_{GS} = 0$
DRAIN CURRENT
GATE TO SOURCE VOLTAGE
GATE-SOURCE CUT-OFF VOLTAGE
GATE-SOURCE BREAKDOWN VOLTAGE ($V_{DS} = 0$)
TRANSCONDUCTANCE
OUTPUT POWER
OUTPUT POWER (- 1 dB GAIN COMPRESSION)
VOLTAGE STANDING WAVE RATIO

transistors à effet de champ Ga As

Ga As FETs



BMH 60

BMH 77 p

TEC de moyenne et forte puissance

medium and high power FETs

CONDITIONS DE MESURES TEST CONDITIONS		$I_{DS} = \frac{I_{DSS}}{2}$ $V_{DS} = 7 \text{ V typ}$		$P = P_{01}$	$V_{DS} = 3 \text{ V}$ $V_{GS} = 0 \text{ V}$	$I_{DS} = I_{DSS}$	$V_{DS} = 3 \text{ V}$	$V_{DS} = 0 \text{ V}$	CONDITIONS LIMITES LIMITING CONDITIONS	
CARACTÉRISTIQUES A SPECIFICATIONS AT		$T = 25 \text{ }^\circ\text{C}$		P_{01}	G_p	I_{DSS}	g_m	V_{GSp}	V_{BRGSS}	TEMPÉRATURES $^\circ\text{C}$ TEMPERATURES $^\circ\text{C}$
TYPE TYPE	BOITIER CASE	FRÉQUENCE DE MESURE TEST FREQUENCY GHz	mW min	dB typ	mA typ	r_{on} typ	V v_{max}	V v_{max}	FONCTION. OPERATING	STOCKAGE STORAGE
TC 5201	BMH 60	6 4	1000 1000	7 9	1000 1000	300 300	8 8	12 12		
TC 5251 (1)	BMH 60	7.7 - 8.5	1000	7	1000	300	8	12		
TC 5200	BMH 60	6	500	7	500	150	8	12		
	BMH 77p	4	500	9	500	150	8	12		
TC 5250 (1)	BMH 60	7.7 - 8.5	500	7	500	150	8	12		
TC 4200	BMH 60	6	200	7.5	300	75	8	12		
	BMH 77p	4	200	10	300	75	8	12		
TC 4250 (1)	BMH 60	7.7 - 8.5	200	7.5	300	75	8	12	- 40 + 70	- 65 + 170
TC 3201	BMH 60	6	100	8	200	50	8	12		
	BMH 77p	4	100	10	200	50	8	12		
TC 3200	BMH 60	6	50	9	100	25	8	12		
	BMH 77p	4	50	12	100	25	8	12		
TC 4400	BMH 60	10	200	6.5	300	75	8	12		
TC 3401	BMH 60	10	100	7	150	50	8	12		
	BMH 77p									
TC 3400	BMH 60	10	50	8	75	25	8	12		
	BMH 77p									
TC 4500	BMH 60	12	150	6	150	50	8	12		
TC 3500	BMH 60	12	50	6.5	75	25	8	12		

(1) Préadapté en entrée
Input matched

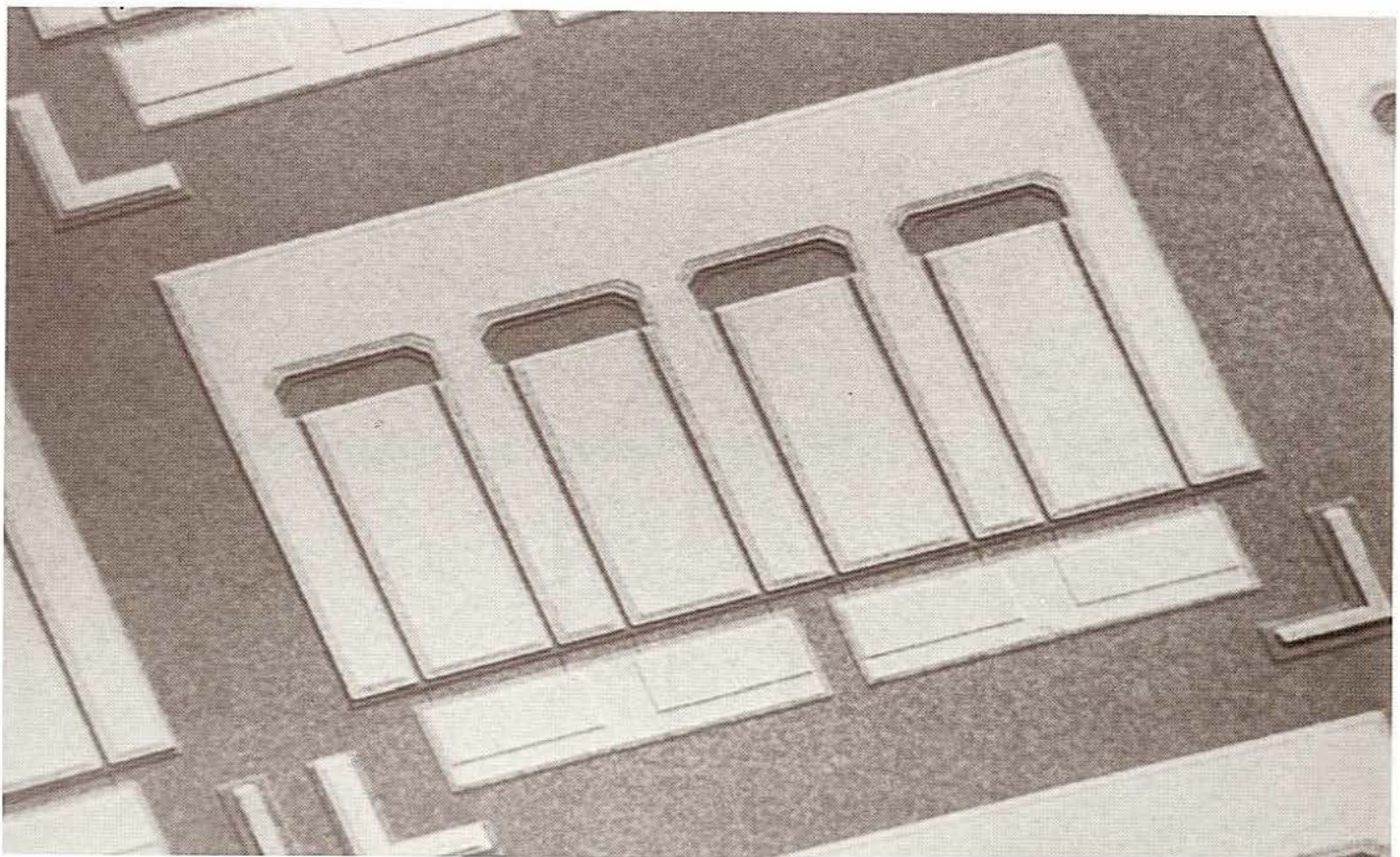

transistors à effet de champ Ga As

Ga As FETs

TEC Autopolarisés et Prédaptés (TECAP) self biased and matched FETs

CARACTÉRISTIQUES A SPECIFICATIONS AT		T = 25 °C		P _O	G _p	R.O.S V.S.W.R	ALIMENTATION DC POWER		CONDITIONS LIMITES LIMITING CONDITIONS	
TYPE	BOITIER CASE	BANDE DE FRÉQUENCE BANDWIDTH GHz	mW min	dB min	max	V typ	mA typ	TEMPÉRATURES °C TEMPERATURES °C FONCTION. STOCKAGE OPERATING STORAGE		
TC 9302	BMH 60	8.5 - 9.6	50	7	2	10	40			
TC 9303	BMH 60	8.5 - 9.6	100	6.5	2	10	80			
TC 9311	BMH 60	9 - 10.2	50	7	2	10	40			
TC 9312	BMH 60	9 - 10.2	100	6.5	2	10	80			
TC 9402	BMH 60	10.2 - 11.7	50	6	2	10	40	- 40 + 70		- 65 + 170
TC 9403	BMH 60	10.2 - 11.7	100	5	2	10	80			
TC 9501	BMH 60	11.7 - 13.2	50	6	2	10	40			
TC 9502	BMH 60	11.7 - 13.2	100	5	2	10	80			
TC 9601	BMH 60	14 - 14.5	40	6	2	10	40			

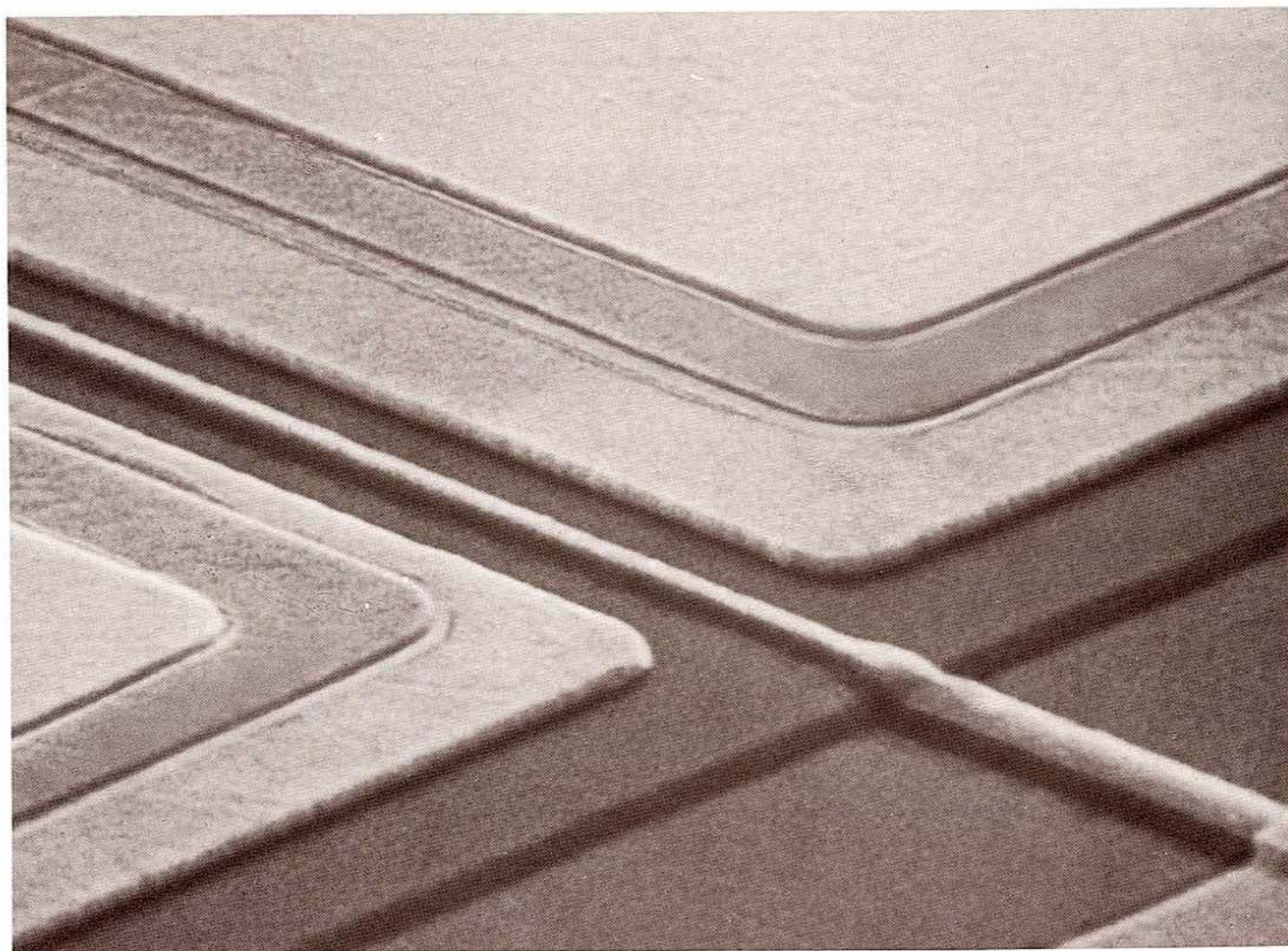



BMH 60

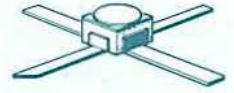

BMH 83

**TEC faible bruit
low noise FETs**

CONDITIONS DE MESURES TEST CONDITIONS		$I_{DS} = \frac{I_{DSS}}{10}$ $V_{DS} = 4\text{ V}$		NF min		$V_{DS} = 4\text{ V}$		$V_{DS} = 3\text{ V}$ $V_{GS} = 0\text{ V}$		$I_D = I_{DSS}$ $V_{DS} = 3\text{ V}$ $V_{DS} = 0\text{ V}$		CONDITIONS LIMITES LIMITING CONDITIONS			
CARACTÉRISTIQUES A SPECIFICATIONS AT		$T = 25\text{ }^\circ\text{C}$		NF min		G_p (N.F. min)		G_p max		I_{DSS} gm		V_{GS} V_{BRGSS}		TEMPÉRATURES $^\circ\text{C}$ TEMPERATURES $^\circ\text{C}$	
TYPE TYPE	BOITIER CASE	FRÉQUENCE DE MESURE TEST FREQUENCY	dB typ	dB max	dB min	dB typ	dB typ	mA typ	mS typ	V max	V max	FONCTION OPERATING	STOCKAGE STORAGE		
TC 1100	BMH 83	4	1.5	2	10	12	15	75	25	6	10				
TC 1101 (1)	BMH 83	4	1.5	2	10	12	15	150	50	6	10	- 40 + 70	- 65 + 170		
TC 1400	BMH 83	10	2.5	3	7.5	8.5	11	80	35	6	10				

(1) Faible intermodulation 3^e ordre
Low IM 3

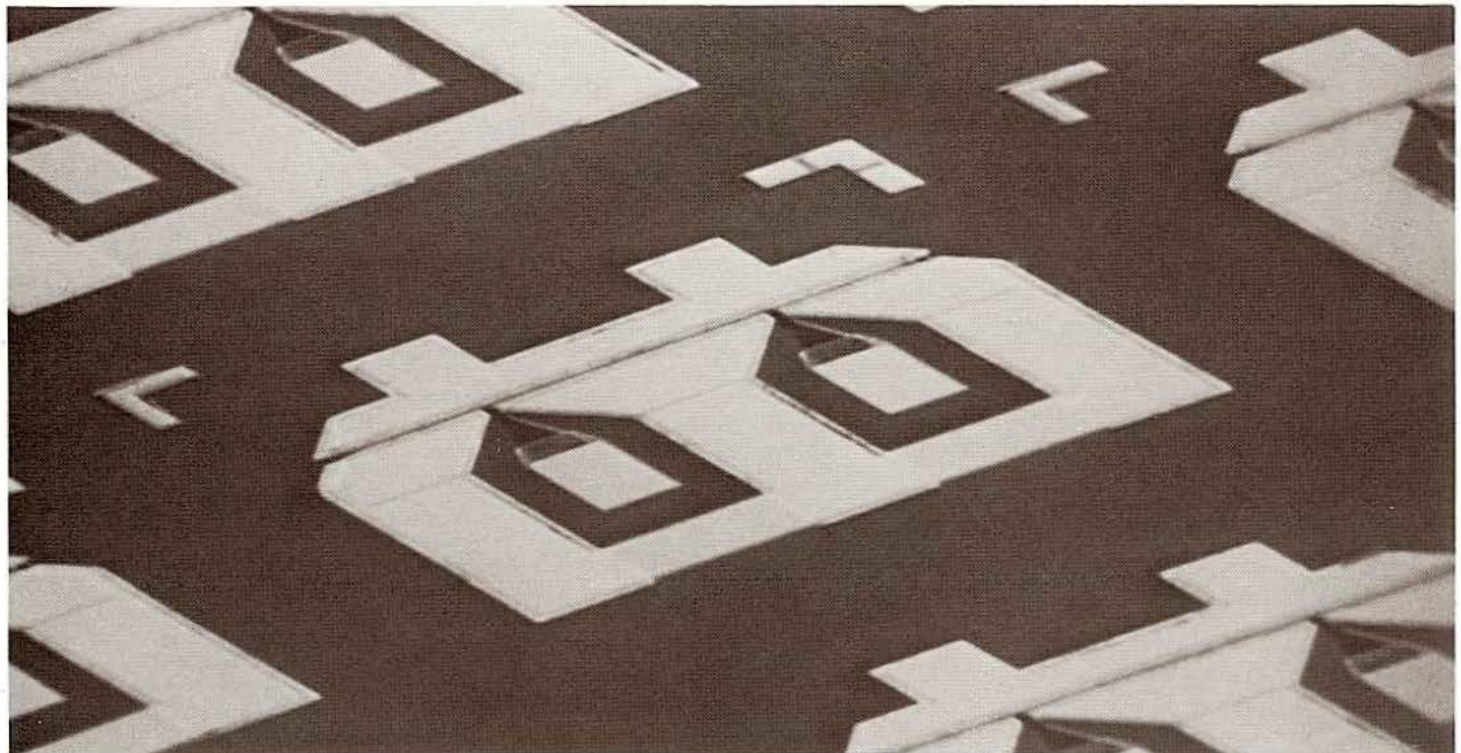
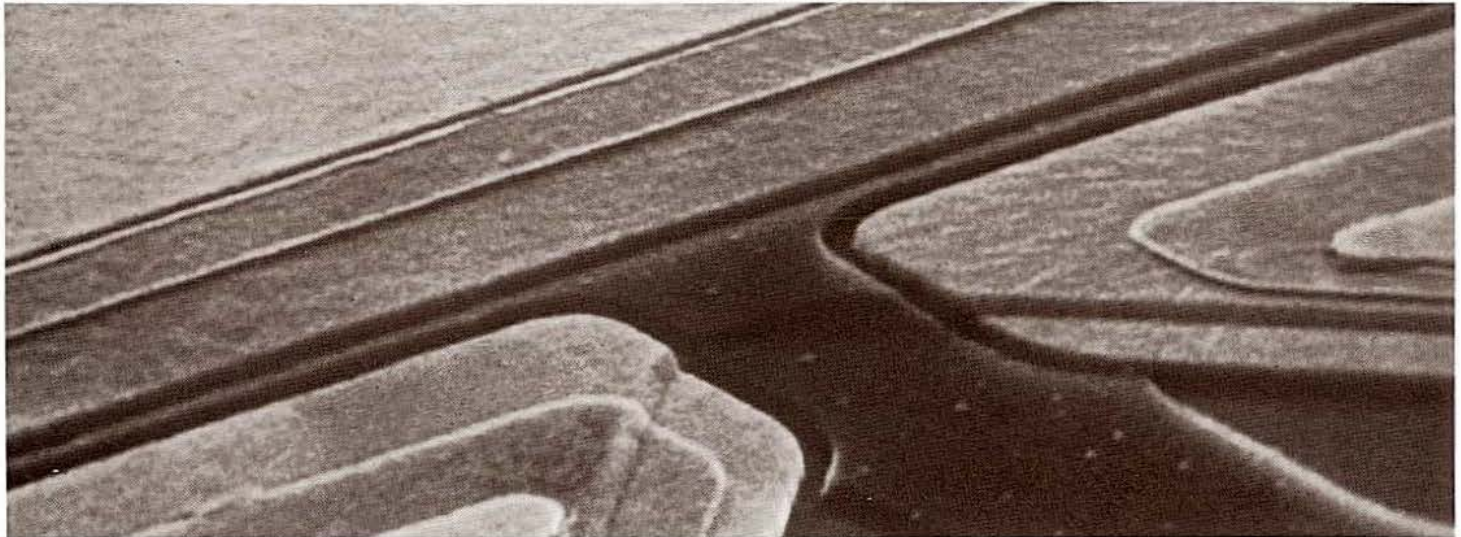

fonctions microonde
microwave assemblies

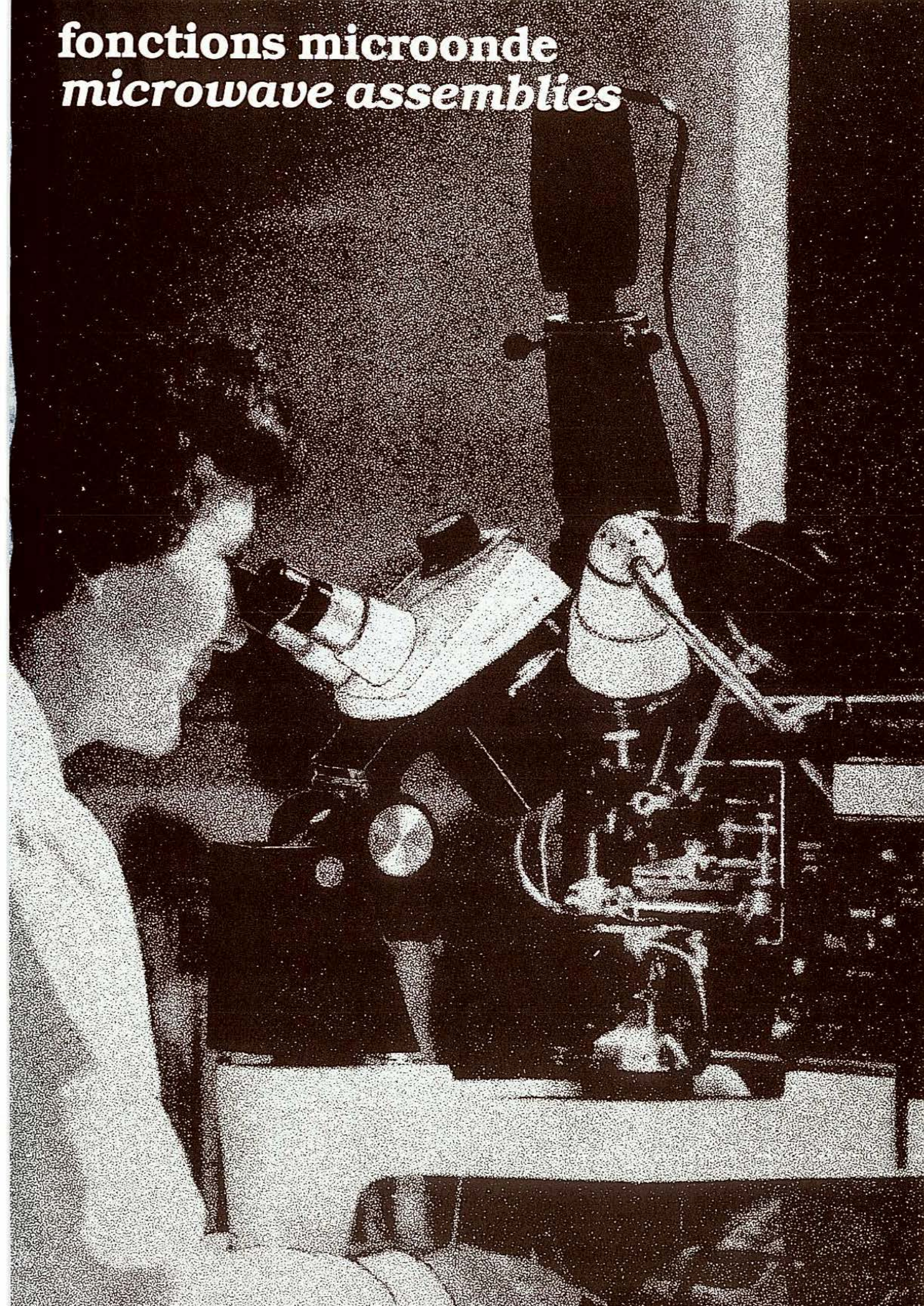

La Division Composants Microonde de THOMSON-CSF a développé un ensemble de fonctions microonde réalisées par l'association de circuits très élaborés avec des composants le plus souvent en puce. Ces dispositifs, qui présentent sous un faible encombrement des performances élevées, en particulier en largeur de bande, sont bien adaptés aux applications contre-mesures électroniques (CME).

Les fonctions microonde regroupent :

- Les oscillateurs à diode Gunn parmi lesquels les oscillateurs à large bande d'accord pour les contre-mesures électroniques (CME) et les oscillateurs à résonateur diélectrique à faible bruit et grande stabilité.
- Les amplificateurs à TEC Ga As parmi lesquels les amplificateurs large bande (octave et multioctaves) qui remplacent avantageusement les TOP bas niveau, grâce à leur faible encombrement. Une attention particulière a été portée à la stabilité du gain dans le temps.
- Les modules microonde regroupent des dispositifs à large bande tels que interrupteurs à diode PIN, commutateurs, limiteurs, transformateurs, coupleurs hybrides, diviseurs de puissance. Les mélangeurs sont réalisés en technologie microcablée jusqu'à 3 GHz; pour les fréquences supérieures on fait appel aux technologies microélectroniques.
- Les modules TO 8 permettent de réaliser sous un faible encombrement les fonctions de traitement du signal avec :
 - Les amplificateurs cascadables à large bande
 - Les oscillateurs
 - Les atténuateurs et interrupteurs
 - Les lignes à retard.

THOMSON-CSF Microwave Component Division has developed a range of microwave assemblies incorporating highly sophisticated circuits with components which are quite often presented as chips.

These compact and high performance (wide bandwidth) devices are especially suitable for electronic countermeasure applications (ECM).

Microwave assemblies include :

- Gunn diode oscillators including wideband tuning oscillators for electronic countermeasures (ECM) and high stability, low noise dielectric resonator oscillators.
- GaAs FET amplifiers including wideband amplifiers (octave and multi-octave bandwidth) which favorably replace low level TWT's, thanks to their compactness. Particular care was paid to gain stability over time.
- Microwave modules include wideband devices, such as PIN diode switches, commutators, limiters, transformers, hybrid couplers and power dividers. Micro-wiring technology is used for manufacturing mixers up to 3 GHz, and micro-electronic technologies are used for higher frequencies.
- TO 8 modules make it possible to build up compact signal processing assemblies with :
 - wideband cascadable amplifiers
 - oscillators
 - attenuators and switches
 - delay lines

symboles

V_F	TENSION DIRECTE CONTINUE
V_R	TENSION INVERSE CONTINUE
I_F	COURANT DIRECT CONTINU
I_R	COURANT INVERSE CONTINU
$P_{r\max}$	PUISSANCE RF MAXIMUM ADMISSIBLE
R.O.S. V.S.W.R.	RAPPORT D'ONDE STATIONNAIRE
R_V	RÉSISTANCE VIDÉO
K	SENSIBILITÉ EN TENSION
T_{ss}	SENSIBILITÉ TANGENTIELLE

symbols

V_F	FORWARD DIRECT VOLTAGE
V_R	REVERSE DIRECT VOLTAGE
I_F	FORWARD DIRECT CURRENT
I_R	REVERSE DIRECT CURRENT
$P_{r\max}$	MAXIMUM RF POWER
R.O.S. V.S.W.R.	VOLTAGE STANDING WAVE RATIO
R_V	VIDEO RESISTANCE
K	VOLTAGE SENSITIVITY
T_{ss}	TANGENTIAL SENSITIVITY

oscillateurs oscillators

oscillateurs à diode Gunn à accord mécanique mechanically tuned Gunn diode oscillators

CARACTÉRISTIQUES A T = 25°C - SPECIFICATIONS AT T = 25°C

TYPE TYPE	GAMME DE FRÉQUENCE RANGE GHz	PUISSANCE DE SORTIE OUTPUT POWER mW	BANDE D'ACCORD TUNING RANGE MHz	DÉRIVE EN FRÉQUENCE, FONCTION DE LA FREQUENCY DRIFT, VERSUS :		GAMME DE TEMPÉRATURES TEMPERATURE RANGE °C	POLARISATION BIAS TENSION VOLTAGE V		CONNECTEUR OU GUIDE CONNECTOR OR WAVEGUIDE	BOITIER OU DIMENSIONS* CASE OR DIMENSIONS mm
				TEMPÉRATURE TEMPERATURE MHz/°C	TENSION D'ALIMENTATION PUSHING MHz/V		COURANT CURRENT mA			
TH 5112	6 - 14	≥ 100	± 25	≤ 0.5	régulateur incorporé voltage regulator	0 + 60			SMA	15x15x65
TH 5102	8 - 12.4	≥ 100	± 50	≤ 1	30	- 10 + 50	≤ 12	≤ 650	RG 52/U	TH 5102
MH 571	8.5 - 10.5	≥ 40	± 1000	0.5	5	- 40 + 70	≤ 11	≤ 500	SMA	31.5x18.4x31.8
MH 573	9 - 11	≥ 40	± 1000	0.5	5	- 40 + 70	≤ 11	≤ 500	SMA	31.5x18.4x31.8
MH 575	10 - 12	≥ 40	± 1000	0.5	5	- 40 + 70	≤ 11	≤ 500	SMA	31.5x18.4x31.8
TH 5114	12.4 - 18	≥ 100	± 500	≤ 2	100	- 10 + 50	≤ 10	≤ 700	RG 52/U	TH 5114
TH 5115	18 - 26.5	≥ 50	± 1000	≤ 2	140	- 10 + 50	≤ 9	≤ 650	RG 53/U	TH 5115

oscillateurs à diode Gunn à accord mécanique et électrique mechanically and electrically tuned Gunn diode oscillators

CARACTÉRISTIQUES A T = 25°C - SPECIFICATIONS AT T = 25°C

TYPE TYPE	GAMME DE FRÉQUENCE RANGE GHz	PUISSANCE DE SORTIE OUTPUT POWER mW	BANDE D'ACCORD TUNING RANGE Mec. MHz	Elec. MHz	DÉRIVE EN FRÉQUENCE, FONCTION DE LA : FREQUENCY DRIFT, VERSUS :		GAMME DE TEMPÉRATURES TEMPERATURE RANGE °C	POLARISATION BIAS TENSION VOLTAGE V		CONNECTEUR OU GUIDE CONNECTOR OR WAVEGUIDE	BOITIER CASE mm
					TEMPÉRATURE TEMPERATURE MHz/°C	TENSION D'ALIMENTATION PUSHING MHz/V		COURANT CURRENT mA			
TH 5111	8.5 - 9.6	≥ 20	± 225	± 12	≤ 0.2	≤ 15	- 10 + 50	≤ 12	≤ 650	SMA	TH 5111
TH 5118	8.5 - 12.4	≥ 50	± 100	± 100	≤ 1	≤ 50	- 10 + 50	≤ 12	≤ 650	RG 52/U	TH 5118

oscillateurs à diode Gunn accordables par varactor (large bande - contre mesures) varactor tuned Gunn diode oscillators (wide tuning range - ECM)

CARACTÉRISTIQUES A T = 25°C - SPECIFICATIONS AT T = 25°C

TYPE TYPE	BANDE DE FRÉQUENCE RANGE GHz	PUISSANCE DE SORTIE OUTPUT POWER mW	BANDE D'ACCORD TUNING RANGE MHz	TENSION D'ACCORD TUNING VOLTAGE V	BANDE PASSANTE DE MODULATION MODULATION BANDWIDTH MHz	RÉJECTION HARMONIQUE HARMONICS dB	GAMME DE TEMPÉRATURE TEMPERATURE RANGE °C	POLARISATION BIAS TENSION VOLTAGE V		CONNECTEUR CONNECTOR	BOITIER OU DIMENSIONS* CASE OR DIMENSIONS mm
								COURANT CURRENT mA			
MH 565	6 - 8	≥ 10	2000	0 - 40	≥ 10	≥ 15	- 40 + 85	13	750	SMA	
MH 566	8 - 10	≥ 10	2000	0 - 40	≥ 10	≥ 15	- 40 + 85	10	750	SMA	
MH 567	10 - 12	≥ 10	2000	0 - 40	≥ 10	≥ 15	- 40 + 85	10	750	SMA	22 x 21 x 11
MH 568	12 - 15	≥ 10	3000	0 - 40	≥ 10	≥ 15	- 40 + 85	7	800	SMA	
MH 569	15 - 18	≥ 10	3000	0 - 40	≥ 10	≥ 15	- 40 + 85	7	800	SMA	

oscillateurs à diode Gunn accordables par varactor varactor tuned Gunn diode oscillators

CARACTÉRISTIQUES A T = 25°C - SPECIFICATIONS AT T = 25°C

TYPE TYPE	BANDE FRÉQUENCE RANGE GHz	PUISSANCE DE SORTIE OUTPUT POWER mW	BANDE D'ACCORD TUNING RANGE MHz	BANDE PASSANTE DE MODULATION MODULATION BANDWIDTH MHz	RÉJECTION HARMONIQUE HARMONICS dB	GAMME DE TEMPÉRATURE TEMPERATURE RANGE °C	DÉRIVE EN FRÉQUENCE FONCTION DE LA TEMP. FREQUENCY DRIFT, VERSUS TEMPERATURE MHz/°C	POLARISATION BIAS TENSION VOLTAGE V		CONNECTEUR CONNECTOR	BOITIER OU DIMENSIONS* CASE OR DIMENSIONS mm
								COURANT CURRENT mA			
TH 5124	8.5 - 10.5	≥ 25	± 500	≥ 20	≥ 20	- 10 + 50	≤ 0.5	12	650	SMA	TH 5124
TH 5109	9 - 10	≥ 25	+ 250	≥ 20	≥ 20	- 40 + 85	≤ 0.5	12	650	SMA	TH 5109

*Autres boîtiers sur demande - Other cases : please, refer to THOMSON-CSF

oscillateurs oscillators



TH 5129

oscillateurs à diode Gunn à résonateur diélectrique dielectric resonator controlled Gunn diode oscillators

CARACTÉRISTIQUES A T = 25°C - SPECIFICATIONS AT T = 25°C

TYPE TYPE	GAMME DE FRÉQUENCE FREQUENCY RANGE	PUISSANCE DE SORTIE OUTPUT POWER	BANDE D'ACCORD TUNING RANGE	DÉRIVE EN FRÉQUENCE, FONCTION DE LA :		GAMME DE TEMPÉRATURES TEMPERATURE RANGE	POLARISATION BIAS TENSION VOLTAGE	CONNECTEUR OU GUIDE CONNECTOR OR WAVEGUIDE	BOITIER OU DIMENSIONS* CASE OR DIMENSIONS
				TEMPÉRATURE TEMPERATURE	TENSION D'ALIMENTATION PUSHING VOLTAGE				
	GHz	mW	MHz	MHz/°C	MHz/V	°C	V		mm
(1) TH 5129	8 - 12.4	≥ 30	± 100	≤ 0.05	régulateur incorporé voltage regulator	- 20 + 50	12 - 15	SMA	TH 5129
TH 5130	13 - 16	≥ 10	± 100	≤ 0.05		- 20 + 50	12	SMA	TH 5130

(1) Bruit FM dans 1 Hz de bande à 10 KHz de la porteuse - SSB FM noise in 1 Hz B.W. and 10 KHz from carrier : -100 dB

*Autres boîtiers sur demande - Other cases : please, refer to THOMSON-CSF

amplificateurs amplifiers



MH 758-1

amplificateurs à large bande broadband amplifiers

CARACTÉRISTIQUES A T = 25°C - SPECIFICATIONS AT T = 25°C

MODELE MODEL	BOITIER CASE	BANDE DE FRÉQUENCE RANGE GHz	GAIN MOYEN MEAN POWER GAIN dB	FACTEUR DE BRUIT NOISE FIGURE dB	PUISSANCE DE SORTIE - 1 dB COMPRES. OUTPUT POWER - 1 dB COMPRES. dBm typ	ONDULATION DU GAIN GAIN FLATNESS dB	POINT D'INTER- SECTION INTERCEPT. POINT dBm typ	R.O.S ENTRÉE/ SORTIE V.S.W.R IN/OUT max	DANS LA GAMME DE TEMPÉRATURES IN TEMPERATURE RANGE		GAMME DE TEMPÉRATURE °C TEMPERATURE RANGE FONCTION. OPERATING °C
									GAIN min MIN. POWER GAIN dB	VAR. DU GAIN GAIN VARIATIONS dB	
MH 752-1	BMH 133	2 - 4	25	4,5	10	± 1	22	2	22	± 2,1	- 40 + 80
MH 753-1	BMH 134	3 - 7	32	5	10	± 1,5	22	2	27,5	± 2,8	
MH 754-1	BMH 134	4 - 8	29	6	10	± 1,5	22	2	24,5	± 2,8	
MH 755-1	BMH 134	2,5 - 8	28	6	10	± 1,5	22	2	23,5	± 2,8	
MH 756-1	BMH 134	7 - 11	30	7	10	± 1	22	2	25,5	± 2,8	
MH 757-1	BMH 135 BMH 138	8 - 12,4	30	8	10	± 1,5	22	2	25	± 3,5	
MH 758-1	BMH 143 (BMH 141) x 2	10 - 18	32	10	10	± 1,5	22	2	26,5	± 4	
MH 759-1	BMH 143 (BMH 141) x 2	6 - 18	30	10	10	± 2	22	2	24	± 4	
MH 759-2	BMH 142	6 - 18	20	10	10	± 2	22	2			

amplificateurs a faible bruit low noise amplifiers

CARACTÉRISTIQUES A T = 25°C - SPECIFICATIONS AT T = 25°C

MODÈLE MODEL	BOITIER CASE	BANDE DE FRÉQUENCE RANGE GHz	GAIN MOYEN MEAN POWER GAIN dB	FACTEUR DE BRUIT NOISE FIGURE dB	PUISSANCE DE SORTIE - 1 dB COMPRES OUTPUT POWER - 1 dB COMPRES. dBm typ	ONDULATION DU GAIN GAIN FLATNESS dB	POINT D'INTER- SECTION INTERCEPT POINT dBm typ	R.O.S ENTRÉE/ SORTIE V.S.W.R IN/OUT max	GAMME DE TEMPÉRATURE °C TEMPERATURE RANGE FONCTION. OPERATING °C
MH 769-2	BMH 132	5,4 - 5,9	17	3,5	7	± 0,3	19	1,3	
MH 769-3	BMH 133	5,4 - 5,9	25	3,5	10	± 0,5	22	1,3	
MH 765-1	BMH 133	10 - 10,3	18	3,5	10	± 0,5	22	1,5	
MH 768-1	*	14 - 14,5	17	5	7	± 0,3	19	1,25	

amplificateurs de puissance power amplifiers

CARACTÉRISTIQUES A T = 25°C - SPECIFICATIONS AT T = 25°C

MODÈLE MODEL	BOITIER CASE	BANDE DE FRÉQUENCE RANGE GHz	GAIN MOYEN MEAN POWER GAIN dB	FACTEUR DE BRUIT NOISE FIGURE dB	PUISSANCE DE SORTIE - 1 dB COMPRES OUTPUT POWER - 1 dB COMPRES. dBm typ	ONDULATION DU GAIN GAIN FLATNESS dB	POINT D'INTER- SECTION INTERCEPT POINT dBm typ	R.O.S ENTRÉE/ SORTIE V.S.W.R IN/OUT max	GAMME DE TEMPÉRATURE °C TEMPERATURE RANGE FONCTION. OPERATING °C
MH 772-2	BMH 150	2 - 4	37	6	23	± 2	35	2	
MH 774-1	BMH 148	4 - 8	25	7	23	± 2	35	2	
MH 774-2	BMH 150	4 - 8	33	7	23	± 2	35	2	
MH 776-1	BMH 148	8,5 - 10,5	28	8	23	± 2	35	2	
MH 776-2	BMH 150	8,5 - 10,5	36	8	23	± 2	35	2	
MH 776-3	BMH 147	8,9 - 9,5	10		30	± 0,7		2/3	
MH 786-1	*	8,5 - 10,5	44	8	23	± 2	35	2	

*Nous consulter - Please refer to THOMSON-CSF

NOTA : Autres caractéristiques sur demande : protection en entrée, compensation en température amplificateurs "limités"...

NOTA : Other features on request : high RF input power protection, temperature compensation, limiting amplifiers...

modules microonde microwave modules

interrupteurs SPST de puissance power SPST switches

CONDITIONS DE MESURES TEST CONDITIONS		$V_R = 0\text{ V}$	$I_F = 100\text{ mA}$	$V_R = 0\text{ V}$	$100\text{ mA} - 40\text{ V}$	CONDITIONS LIMITES LIMITING CONDITIONS				
CARACTÉRISTIQUES A SPECIFICATIONS AT		PERTES INSERTION LOSS		DÉCOUPLAGE ISOLATION	R.O.S V.S.W.R	TEMPS DE COMMUTATION SWITCHING TIME	PUISANCE POWER	TEMPÉRATURES °C TEMPERATURES °C		
TYPE TYPE		BOITIER CASE	FRÉQUENCE FREQUENCY GHz	dB	dB	μs	MOYEN MEAN W max	CRÊTE* PEAK kW max	FONCTION. OPERATING	STOCKAGE STORAGE
POLARITÉ POLARITY STANDARD INVERSE STANDARD REVERSE										
MH 108 A	MH 108 RA	BMH 11	0.5 - 2	0.5	35	1.4	1	10	1	
MH 108 B	MH 108 RB	BMH 11	2 - 4	0.75	45	1.4	1	10	1	
MH 108 C	MH 108 RC	BMH 11	4 - 8	1	50	1.6	1	10	1	
MH 108 D	MH 108 RD	BMH 11	8 - 12	1.25	50	1.8	1	10	1	
MH 108 E	MH 108 RE	BMH 11	12 - 18	1.8	45	2	1	10	1	
MH 108 F	MH 108 RF	BMH 11	2 - 12	1.25	45	1.8	1	10	1	
MH 108 G	MH 108 RG	BMH 11	8 - 18	1.8	45	2	1	10	1	- 50 + 150 - 65 + 200
MH 109 A	MH 109 RA	BMH 16	0.5 - 2	0.5	35	1.4	1	10	1	
MH 109 B	MH 109 RB	BMH 16	2 - 4	0.75	45	1.4	1	10	1	
MH 109 C	MH 109 RC	BMH 16	4 - 8	1	50	1.6	1	10	1	
MH 109 D	MH 109 RD	BMH 16	8 - 12	1.25	50	1.8	1	10	1	
MH 109 E	MH 109 RE	BMH 16	12 - 18	1.8	45	2	1	10	1	
MH 109 F	MH 109 RF	BMH 16	2 - 12	1.25	45	1.8	1	10	1	
MH 109 G	MH 109 RG	BMH 16	8 - 18	1.8	45	2	1	10	1	

* $1\mu\text{s} - 1\%_{\infty}$

interrupteurs SPST de puissance à fiches coaxiales power SPST switches, OSM connectors

CONDITIONS DE MESURES TEST CONDITIONS		$V_R = 0\text{ V}$	$I_F = 100\text{ mA}$	$V_R = 0\text{ V}$	$100\text{ mA} - 40\text{ V}$	CONDITIONS LIMITES LIMITING CONDITIONS				
CARACTÉRISTIQUES A SPECIFICATIONS AT		PERTES INSERTION LOSS		DÉCOUPLAGE ISOLATION	R.O.S V.S.W.R	TEMPS DE COMMUTATION SWITCHING TIME	PUISANCE POWER	TEMPÉRATURES °C TEMPERATURES °C		
TYPE TYPE		BOITIER CASE	FRÉQUENCE FREQUENCY GHz	dB	dB	μs	MOYEN MEAN W max	CRÊTE** PEAK kW max	FONCTION. OPERATING	STOCKAGE STORAGE
POLARITÉ POLARITY STANDARD INVERSE STANDARD REVERSE										
MH 141	MH 141 R	BMH 2	0.5 - 2	0.5	35	1.4	1	10	1	
MH 142	MH 142 R	BMH 2	2 - 4	0.75	45	1.4	1	10	1	
MH 143	MH 143 R	BMH 2	4 - 8	1	50	1.6	1	10	1	
MH 144	MH 144 R	BMH 2	8 - 12	1.25	50	1.8	1	10	1	
MH 145	MH 145 R	BMH 2	12 - 18	1.8	45	2	1	10	1	
MH 146	MH 146 R	BMH 2	2 - 12	1.25	45	1.8	1	10	1	
MH 147	MH 147 R	BMH 2	8 - 18	1.8	45	2	1	10	1	- 50 + 150 - 65 + 200
*MH 115	MH 115 R	BMH 3	0.5 - 2	0.6	35	1.5	1	10	1	
*MH 116	MH 116 R	BMH 3	2 - 4	0.8	45	1.5	1	10	1	
*MH 117	MH 117 R	BMH 3	4 - 8	1	50	1.6	1	10	1	
*MH 118	MH 118 R	BMH 3	8 - 12	1.5	50	1.8	1	10	1	
*MH 120	MH 120 R	BMH 3	12 - 18	2	45	2	1	10	1	
*MH 110	MH 110 R	BMH 3	4 - 12	1.8	45	2	1	10	1	
MH 111	MH 111 R	BMH 3	8 - 18	2.3	45	2.2	1	10	1	

* Polarisation incorporée - * Incorporated bias

** $1\mu\text{s} - 1\%_{\infty}$

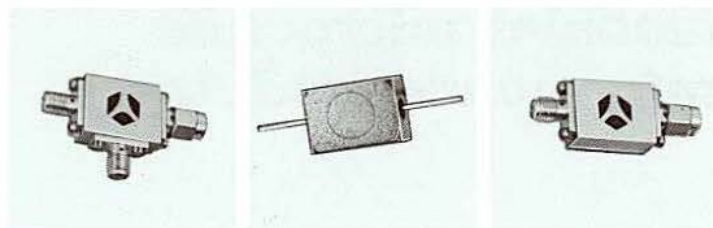

MH 120

MH 109 E

MH 225

interrupteurs SPST rapides fast SPST switches

CONDITIONS DE MESURES TEST CONDITIONS		$V_R = -10\text{ V}$	$I_F = 20\text{ mA}$	$V_R = -10\text{ V}$	20 mA - 6 V	CONDITIONS LIMITES LIMITING CONDITIONS				
CARACTÉRISTIQUES A SPECIFICATIONS AT		T = 25°C	PERTES INSERTION LOSS	DÉCOUPLAGE ISOLATION	R.O.S V.S.W.R	TEMPS DE COMMUTATION SWITCHING TIME	PUISSANCE POWER	TEMPÉRATURES °C TEMPERATURES °C		
TYPE TYPE	BOITIER CASE	FRÉQUENCE FREQUENCY GHz	dB	dB		μs	MOYEN MEAN W max	CRÊTE** PEAK W max	FONCTION OPERATING	STOCKAGE STORAGE
MH 238 A	BMH 11	0.5 - 2	0.5	35	1.4	20	1	5		
MH 238 B	BMH 11	2 - 4	0.75	45	1.4	20	1	5		
MH 238 C	BMH 11	4 - 8	1.25	50	1.6	20	1	5		
MH 238 D	BMH 11	8 - 12	1.75	50	2	20	1	5		
MH 238 E	BMH 11	12 - 18	2.3	45	2	20	1	5		
MH 238 F	BMH 11	2 - 12	1.75	45	2	20	1	5		
MH 238 G	BMH 11	8 - 18	2.3	45	2	20	1	5	- 50 + 150	- 65 + 200
MH 239 A	BMH 16	0.5 - 2	0.5	35	1.4	20	1	5		
MH 239 B	BMH 16	2 - 4	0.75	45	1.4	20	1	5		
MH 239 C	BMH 16	4 - 8	1.25	50	1.6	20	1	5		
MH 239 D	BMH 16	8 - 12	1.75	50	2	20	1	5		
MH 239 E	BMH 16	12 - 18	2.3	45	2	20	1	5		
MH 239 F	BMH 16	2 - 12	1.75	45	2	20	1	5		
MH 239 G	BMH 16	8 - 18	2.3	45	2	20	1	5		

* 1μs - 1^{1/2}ms

interrupteurs SPST à fort découplage high isolation SPST switches

CONDITIONS DE MESURES TEST CONDITIONS		$V_R = -10\text{ V}$	$I_F = -30\text{ mA}$	$V_R = -10\text{ V}$	30 mA - 6 V	CONDITIONS LIMITES LIMITING CONDITIONS				
CARACTÉRISTIQUES A SPECIFICATIONS AT		T = 25°C	PERTES INSERTION LOSS	DÉCOUPLAGE ISOLATION	R.O.S V.S.W.R	TEMPS DE COMMUTATION SWITCHING TIME	PUISSANCE POWER	TEMPÉRATURES °C TEMPERATURES °C		
TYPE TYPE	BOITIER CASE	FRÉQUENCE FREQUENCY GHz	dB	dB		μs	MOYEN MEAN W max	CRÊTE* PEAK W max	FONCTION OPERATING	STOCKAGE STORAGE
MH 261 A	BMH 85	0.5 - 2	0.6	40	1.8	20	1	5		
MH 261 B	BMH 85	2 - 4	1	55	1.8	20	1	5		
MH 261 C	BMH 85	4 - 8	1.5	70	2	20	1	5	- 50 + 150	- 65 + 200
MH 261 D	BMH 85	8 - 12	2	70	2	20	1	5		
MH 261 F	BMH 85	2 - 12	2	55	2	20	1	5		

* 1μs - 1^{1/2}ms

interrupteurs SPST rapides à fiches coaxiales fast SPST switches, OSM connectors

CONDITIONS DE MESURES TEST CONDITIONS		$V_R = -10\text{ V}$	$I_F = 20\text{ mA}$	$V_R = -10\text{ V}$	20 mA - 6 V	CONDITIONS LIMITES LIMITING CONDITIONS				
CARACTÉRISTIQUES A SPECIFICATIONS AT		T = 25°C	PERTES INSERTION LOSS	DÉCOUPLAGE ISOLATION	R.O.S V.S.W.R	TEMPS DE COMMUTATION SWITCHING TIME	PUISSANCE POWER	TEMPÉRATURES °C TEMPERATURES °C		
TYPE TYPE	BOITIER CASE	FRÉQUENCE FREQUENCY GHz	dB	dB		μs	MOYEN MEAN W max	CRÊTE* PEAK W max	FONCTION OPERATING	STOCKAGE STORAGE
MH 228	BMH 2	0.5 - 2	0.5	35	1.4	20	1	5		
MH 222	BMH 2	2 - 4	0.75	45	1.4	20	1	5		
MH 223	BMH 2	4 - 8	1.25	50	1.6	20	1	5		
MH 224	BMH 2	8 - 12	1.75	50	2	20	1	5		
MH 225	BMH 2	12 - 18	2.3	45	2	20	1	5		
MH 226	BMH 2	2 - 12	1.75	45	2	20	1	5		
MH 227	BMH 2	8 - 18	2.3	45	2	20	1	5	- 50 + 150	- 65 + 200
MH 245*	BMH 3	1 - 2	0.5	35	1.5	20	1	5		
MH 246*	BMH 3	2 - 4	0.75	45	1.5	20	1	5		
MH 247*	BMH 3	4 - 8	1.25	50	1.6	20	1	5		
MH 248*	BMH 3	8 - 12	1.75	50	2	20	1	5		
MH 249*	BMH 3	12 - 18	2.3	45	2	20	1	5		
MH 240*	BMH 3	4 - 12	2.2	45	2	20	1	5		
MH 241*	BMH 3	8 - 18	2.5	45	2.2	20	1	5		

* Polarisation incorporée - Incorporated bias

* 1μs - 1^{1/2}ms

modules microonde microwave modules

interrupteurs à commande incorporée incorporated driver switches

CONDITIONS DE MESURES TEST CONDITIONS			NIVEAU 0 LEVEL 0 "PASSANT" "SWITCH ON"	NIVEAU 1 LEVEL 1 "BLOQUE" "SWITCH OFF"	NIVEAU 0 LEVEL 0 "PASSANT" "SWITCH ON"	T.T.L.	T.T.L.	R.F.	CONDITIONS LIMITES LIMITING CONDITIONS				
CARACTÉRISTIQUES A SPECIFICATIONS AT			T = 25°C		PERTES INSERTION LOSS	DÉCOUPLAGE ISOLATION	R.O.S V.S.W.R	TEMPS DE COMMUTATION SWITCHING TIME	POLARISATION BIAS	PUISSANCE D'ENTRÉE INPUT POWER		TEMPÉRATURES °C TEMPERATURES °C	
TYPE TYPE	BOITIER CASE	FRÉQUENCE FREQUENCY GHz	dB max	dB min	max	ns max	ns max	V	mA typ	MOYEN MEAN W max	CRÊTE* PEAK W max	FONCTION OPERATING	STOCKAGE STORAGE
MH 255	BMH 152	1 - 2	0.5	35	1.5	30 - 50	15 - 15	+ 5 - 5	50	1	5		
MH 256	BMH 152	2 - 4	0.75	45	1.5	30 - 50	15 - 15	+ 5 - 5	50	1	5		
MH 257	BMH 152	4 - 8	1.25	50	1.6	30 - 50	15 - 15	+ 5 - 5	50	1	5		
MH 258	BMH 152	8 - 12	1.75	50	2	30 - 50	15 - 15	+ 5 - 5	50	1	5	- 50 + 115	- 65 + 125
MH 259	BMH 152	12 - 18	2.3	45	2	30 - 50	15 - 15	+ 5 - 5	50	1	5		
MH 250	BMH 152	4 - 12	2.2	45	2	30 - 50	15 - 15	+ 5 - 5	50	1	5		
MH 251	BMH 152	8 - 18	2.5	45	2.2	30 - 50	15 - 15	+ 5 - 5	50	1	5		

*Nous consulter - Please, refer to THOMSON-CSF.

* 1µs - 1%_{ec}

commutateurs SPNT SPNT switches

CONDITIONS DE MESURES TEST CONDITIONS			VOIE PASSANTE PORT "ON"		I = 50 mA typ	I = 100 mA typ	CONDITIONS LIMITES LIMITING CONDITIONS					
CARACTÉRISTIQUES A SPECIFICATIONS AT			T = 25°C		PERTES INSERTION LOSS	DÉCOUPLAGE ISOLATION	R.O.S V.S.W.R	TEMPS DE COMMUTATION SWITCHING TIME (10% - 90% R.F.)	PUISSANCE* D'ENTRÉE INPUT POWER		TEMPÉRATURES °C TEMPERATURES °C	
TYPE TYPE	BOITIER CASE	FRÉQUENCE FREQUENCY GHz	dB max	dB min	max	ns max	max	ns max	mW CW max	FONCTION OPERATING	STOCKAGE STORAGE	
SP2T												
MH 192 A	BMH 73	0.5 - 2	0.7	60	1.5							
MH 192 B	BMH 73	2 - 4	0.9	60	1.6							
MH 192 C	BMH 73	4 - 8	1.2	55	1.8							
MH 192 D	BMH 73	8 - 12	1.7	50	2	500		250		- 50 + 100	- 65 + 125	
MH 192 E*	BMH 73	12 - 18	2.2	45	2							
MH 192 F	BMH 73	2 - 12	1.7	50	2							
MH 192 G	BMH 73	8 - 18	2.2	45	2							
SP3T												
MH 193 A	BMH 74	0.5 - 2	0.8	60	1.6							
MH 193 B	BMH 74	2 - 4	1.2	60	1.7							
MH 193 C	BMH 74	4 - 8	1.6	55	1.8							
MH 193 D	BMH 74	8 - 12	2.1	50	2	500		250		- 50 + 100	- 65 + 125	
MH 193 E	BMH 74	12 - 18	2.5	45	2							
MH 193 F	BMH 74	2 - 12	2.1	50	2							
MH 193 G	BMH 74	8 - 18	2.5	45	2							
SP4T												
MH 194 A	BMH 74	0.5 - 2	0.9	60	1.6							
MH 194 B	BMH 74	2 - 4	1.3	60	1.7							
MH 194 C	BMH 74	4 - 8	1.7	55	1.8							
MH 194 D	BMH 74	8 - 12	2.2	50	2	500		250		- 50 + 100	- 65 + 125	
MH 194 E	BMH 74	12 - 18	2.8	45	2							
MH 194 F	BMH 74	2 - 12	2.2	50	2							
MH 194 G	BMH 74	8 - 18	2.8	45	2							
SP5T												
MH 195 A	BMH 74	0.5 - 2	0.9	60	1.7							
MH 195 B	BMH 74	2 - 4	1.3	60	1.8							
MH 195 C	BMH 74	4 - 8	1.8	55	1.9							
MH 195 D	BMH 74	8 - 12	2.4	50	2.1	500		250		- 50 + 100	- 65 + 125	
MH 195 E	BMH 74	12 - 18	3	45	2.2							
MH 195 F	BMH 74	2 - 12	2.4	50	2.1							
MH 195 G	BMH 74	8 - 18	3	45	2.2							

* Voie bloquée - Part off.



MH 192 F



MH 341 A



MH 170

commutateurs SP2T à polarisation incorporée incorporated bias SP2T switches

CONDITIONS DE MESURES TEST CONDITIONS			TYPE TYPE	"PASSANT "ON"	"BLOUÉ" "OFF"	10 % → 90 %	90 % → 10 %	CONDITIONS LIMITES LIMITING CONDITIONS		
			MH 162 MH 165	- 50 mA	+ 100 mA					
			MH 168 MH 169	- 40 V	+ 100 mA					
			MH 170 MH 171	- 10 V	+ 20 mA					

CARACTÉRISTIQUES A SPECIFICATIONS AT			T = 25 °C	PERTES INSERTION LOSS	DÉCOUPLAGE ISOLATION	R.O.S V.S.W.R	TEMPS DE COMMUTATION SWITCHING TIME		PUISSANCE D'ENTRÉE INPUT POWER		TEMPÉRATURES °C TEMPERATURES °C	
TYPE TYPE	BOITIER CASE	FRÉQUENCE FREQUENCY GHz		dB max	dB min	max	µs max	µs max	MOYEN. MEAN W max	CRÊTE* PEAK W max	FONCTION. OPERATING	STOCKAGE STORAGE
MH 162	BMH 5	1 - 2		0.75	60	1.5	3	1	0.5	100		
MH 163	BMH 5	2 - 4		0.75	55	1.6	3	1	0.5	100		
MH 164	BMH 5	3 - 6		1	55	1.6	3	1	0.5	100		
MH 165	BMH 5	4 - 8		1.25	50	1.8	3	1	0.5	100	- 50 + 115	- 65 + 125
MH 168	BMH 59	6 - 12		2	50	2	1	1	5	500		
MH 169	BMH 59	12 - 18		2.3	45	2	1	1	5	500		
MH 170	BMH 59	6 - 12		2	50	2	0.020	0.020	1	5		
MH 171	BMH 59	12 - 18		2.5	50	2	0.020	0.020	1	5		

* 1 µs - 1 %

commutateurs SP2T rapides à commande incorporée fast incorporated driver SP2T switches

COMMANDE CONTROL			VOIE PASSANTE PORT "ON"	NIVEAU LEVEL 0	NIVEAU LEVEL 1	T.T.L. 50 % → 90 % 50 % → 10 %	R.F. 10 % → 90 % 90 % → 10 %	CONDITIONS LIMITES LIMITING CONDITIONS						
CARACTÉRISTIQUES A SPECIFICATIONS AT			T = 25 °C	PERTES INSERTION LOSS	DÉCOUPLAGE ISOLATION	R.O.S V.S.W.R	PUISSANCE DE FUITE LEAKTHROUGH POWER	TEMPS DE COMMUTATION SWITCHING TIME		POLARISATION BIAS	PUISSANCE (1) D'ENTRÉE INPUT POWER	TEMPÉRATURES °C TEMPERATURES °C		
TYPE TYPE	BOITIER CASE	FRÉQUENCE FREQUENCY GHz		dB max	dB min	max	mW max	ns max	ns max	V mA typ	CW W max	CRÊTE* PEAK W max	FONCTION. OPERATING	STOCKAGE STORAGE
MH 276	BMH 105	6 - 12		2	50	2		50	15	± 5	50	1	5	
(2) MH 277	BMH 106	6 - 13		3	50	2.5	50	50	15	± 5	50	1	100	- 50 + 115 - 65 + 125
MH 278	BMH 105	12 - 18		2.5	50	2		50	15	± 5	50	1	5	

* 1 µs - 1 % (1) voie bloquée - port off (2) commutateur limiteur - limiting switch

limiteurs passifs à large bande passive broad band limiters

CONDITIONS DE MESURES TEST CONDITIONS			POLARISATION EN C' CIRCUIT SHORT CIRCUITED BIAS			LONGUEUR IMPULSION PULSE LENGTH 1 µs 1 [°] / _∞		PUISSANCE D'ENTRÉE INPUT POWER 1 W CW 100 W 1 µs 1 [°] / _∞		CONDITIONS LIMITES LIMITING CONDITIONS		
CARACTÉRISTIQUES A SPECIFICATIONS AT			T = 25 °C	PERTES INSERTION LOSS	R.O.S V.S.W.R	PUISSANCE D'ENTRÉE INPUT POWER		SEUIL DE LIMITATION LIMITING THRESHOLD		TEMPÉRATURES °C TEMPERATURES °C		
TYPE TYPE	BOITIER CASE	FRÉQUENCE FREQUENCY GHz		dB max	max	W max	CRÊTE PEAK W max	mW max	mW max	FONCTION. OPERATING	STOCKAGE STORAGE	
MH 331 A	BMH 11	0.5 - 2		0.5	1.4	1	100	80	150			
MH 331 B	BMH 11	2 - 4		0.75	1.6	1	100	80	150			
MH 331 C	BMH 11	4 - 8		1.25	1.8	1	100	80	150			
MH 331 D	BMH 11	8 - 12		2	2	1	100	80	150			
MH 331 E	BMH 11	12 - 18		3	2	1	100	80	150			
MH 331 F	BMH 11	2 - 12		2	2	1	100	80	150			
MH 331 G	BMH 11	8 - 18		3	2	1	100	80	150			
MH 341 A	BMH 16	0.5 - 2		0.5	1.4	1	100	80	150	- 50 + 100	- 65 + 125	
MH 341 B	BMH 16	2 - 4		0.75	1.6	1	100	80	150			
MH 341 C	BMH 16	4 - 8		1.25	1.8	1	100	80	150			
MH 341 D	BMH 16	8 - 12		2	2	1	100	80	150			
MH 341 E	BMH 16	12 - 18		3	2	1	100	80	150			
MH 341 F	BMH 16	2 - 12		2	2	1	100	80	150			
MH 341 G	BMH 16	8 - 18		3	2	1	100	80	150			

modules microonde microwave modules

limiteurs passifs à large bande à fiches coaxiales passive broad band limiters, OSM connectors

CONDITIONS DE MESURES TEST CONDITIONS			POLARISATION EN C' CIRCUIT SHORT CIRCUITED BIAS		PUISSANCE D'ENTRÉE INPUT POWER 1 W CW 100 W 1 μ s		CONDITIONS LIMITES LIMITING CONDITIONS		
CARACTÉRISTIQUES A SPECIFICATIONS AT T = 25°C			PERTES INSERTION LOSS	R.O.S V.S.W.R	SEUIL DE LIMITATION LIMITING THRESHOLD		PUISSANCE D'ENTRÉE INPUT POWER		TEMPÉRATURES °C TEMPERATURES °C
TYPE TYPE	BOITIER CASE	FRÉQUENCE FREQUENCY GHz			dB max	mW max	mW max	CW W max	
MH 305	BMH 2	1 - 2	0.5	1.5	80	150	1	100	
MH 306	BMH 2	2 - 4	0.75	1.6	80	150	1	100	
MH 307	BMH 2	4 - 8	1.5	1.8	80	150	1	100	
MH 303	BMH 2	4 - 12	2	2	80	150	1	100	- 50 + 100 - 65 + 125
MH 308	BMH 2	8 - 12	2	2	80	150	1	100	
MH 309	BMH 2	12 - 18	3	2.2	80	150	1	100	
MH 310	BMH 2	8 - 18	3	2.2	80	150	1	100	

* 1 μ s - 1%/ ∞

limiteurs passifs de puissance passive power limiters

CONDITIONS DE MESURES TEST CONDITIONS			POLARISATION EN C' CIRCUIT SHORT CIRCUITED BIAS		PUISSANCE D'ENTRÉE INPUT POWER 2 W CW 1 kW 1 μ s		CONDITIONS LIMITES LIMITING CONDITIONS		
CARACTÉRISTIQUES A SPECIFICATIONS AT T = 25°C			PERTES INSERTION LOSS	R.O.S V.S.W.R	SEUIL DE LIMITATION LIMITING THRESHOLD		PUISSANCE D'ENTRÉE INPUT POWER		TEMPÉRATURES °C TEMPERATURES °C
TYPE TYPE	BOITIER CASE	FRÉQUENCE FREQUENCY GHz			dB max	mW max	mW max	CW W max	
MH 383 A	BMH 16	0.5 - 2	0.6	1.5	100	200	2	1	
MH 383 B	BMH 16	2 - 4	1	2	100	200	2	1	
MH 383 C	BMH 16	4 - 8	1.5	2	100	200	2	1	
MH 383 D	BMH 16	8 - 12	2	2.2	100	200	2	1	- 50 + 100 - 65 + 125
MH 393 A	BMH 11	0.5 - 2	0.6	1.5	100	200	2	1	
MH 393 B	BMH 11	2 - 4	1	2	100	200	2	1	
MH 393 C	BMH 11	4 - 8	1.5	2	100	200	2	1	
MH 393 D	BMH 11	8 - 12	2	2.2	100	200	2	1	

* 1 μ s - 1%/ ∞

limiteurs passifs à faible niveau passive low level limiters

CONDITIONS DE MESURES TEST CONDITIONS			POLARISATION EN C' CIRCUIT SHORT CIRCUITED BIAS		PUISSANCE D'ENTRÉE INPUT POWER 1 W CW 100 W 1 μ s		CONDITIONS LIMITES LIMITING CONDITIONS		
CARACTÉRISTIQUES A SPECIFICATIONS AT T = 25°C			PERTES INSERTION LOSS	R.O.S V.S.W.R	SEUIL DE LIMITATION LIMITING THRESHOLD		PUISSANCE D'ENTRÉE INPUT POWER		TEMPÉRATURES °C TEMPERATURES °C
TYPE TYPE	BOITIER CASE	FRÉQUENCE FREQUENCY GHz			dB max	mW max	mW max	CW W max	
MH 381 A	BMH 16	0.5 - 2	0.6	1.5	50	50	1	100	
MH 381 B	BMH 16	2 - 4	1	1.75	50	50	1	100	
MH 381 C	BMH 16	4 - 8	1.5	2	50	50	1	100	
MH 381 D	BMH 16	8 - 12	2	2	50	50	1	100	
MH 381 E	BMH 16	12 - 18	3	2.2	50	50	1	100	
MH 381 F	BMH 16	2 - 12	2	2	50	50	1	100	
MH 381 G	BMH 16	8 - 18	3	2.2	50	50	1	100	- 50 + 100 - 65 + 125
MH 391 A	BMH 11	0.5 - 2	0.6	1.5	50	50	1	100	
MH 391 B	BMH 11	2 - 4	1	1.75	50	50	1	100	
MH 391 C	BMH 11	4 - 8	1.5	2	50	50	1	100	
MH 391 D	BMH 11	8 - 12	2	2	50	50	1	100	
MH 391 E	BMH 11	12 - 18	3	2.2	50	50	1	100	
MH 391 F	BMH 11	2 - 12	2	2	50	50	1	100	
MH 391 G	BMH 11	8 - 18	3	2.2	50	50	1	100	

* 1 μ s - 1%/ ∞

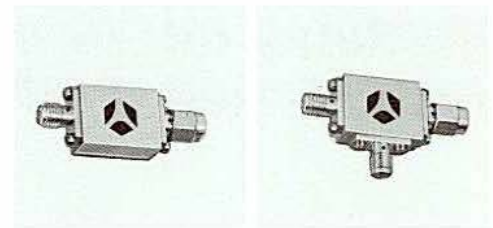

MH 310

MH 128 A

atténuateurs attenuators

CONDITIONS DE MESURES TEST CONDITIONS		$V_R = 0V$ $V_R = 0V$ $I_F = 100\mu A$ $I_F = 1mA$ $I_F = 10mA$ $I_F = 100mA$											CONDITIONS LIMITES LIMITING CONDITIONS				
CARACTÉRISTIQUES A SPECIFICATIONS AT		T = 25 °C		PERTES INSERTION LOSS		R.O.S V.S.W.R		ATTÉNUATION ATTENUATION						TEMPÉRATURES °C TEMPERATURES °C			
TYPE TYPE		BOITIER CASE		FRÉQUENCE FREQUENCY GHz		dB		dB		dB		dB		FONCTION OPERATING		STOCKAGE STORAGE	
POLARITÉ POLARITY																	
STANDARD STANDARD		INVERSE REVERSE				max		max		min		min		max		max	
MH 128 A	MH 128 RA	BMH 3	0.5 - 2	0.6	1.4	1	7	6	14	22	35	40	55				
MH 128 B	MH 128 RB	BMH 3	2 - 4	0.6	1.4	1	7	7	15	25	38	42	60				
MH 128 C	MH 128 RC	BMH 3	4 - 8	1.2	1.6	1	7	8	16	28	42	45	63				
MH 128 D	MH 128 RD	BMH 3	8 - 12	1.6	1.8	1	7	9	17	30	45	48	65	- 50 + 100	- 65 + 125		
MH 128 E	MH 128 RE	BMH 3	12 - 18	2	2	1	7	11	19	35	48	50	66				
MH 128 F	MH 128 RF	BMH 3	2 - 12	1.6	1.8	1	7	7	17	25	45	42	65				
MH 128 G	MH 128 RG	BMH 3	8 - 18	2	2	1	7	9	19	30	48	48	66				

atténuateurs adaptés matched attenuators

CONDITIONS DE MESURES TEST CONDITIONS		COURANT DE COMMANDE CONTROL CURRENT								CONDITIONS LIMITES LIMITING CONDITIONS									
CARACTÉRISTIQUES A SPECIFICATIONS AT		T = 25 °C		PERTES INSERTION LOSS		R.O.S V.S.W.R		ATTÉNUATION ATTENUATION				TEMPÉRATURES °C TEMPERATURES °C							
TYPE TYPE		BOITIER CASE		FRÉQUENCE FREQUENCY GHz		dB		dB		dB		dB		FONCTION OPERATING		STOCKAGE STORAGE			
						max		max		typ		typ		min					
						mA = 0		mA = 0		mA = 1		mA = 5		mA = 10		mA = 50		mA = 100	
MH 123	BMH 107	0.6 - 1.5	1	2	5	12	18	29	30										
MH 125	BMH 108	2.5 - 8	1	2	5	13	20	32	30	- 50 + 100	- 65 + 125								
MH 126	BMH 108	6 - 12	2	2	6	16	24	38	30										
MH 127	BMH 108	6 - 18	3	2	6	16	24	38	30										

détecteurs detectors

CARACTÉRISTIQUES A SPECIFICATIONS AT		T = 25 °C		R_V		K		T_{SS}		R.O.S V.S.W.R.		TEMPÉRATURES °C TEMPERATURES °C			
TYPE TYPE		BOITIER CASE		BANDE PASSANTE BANDWIDTH GHz		Ω		$\mu V/\mu W$		dBm		FONCTION OPERATING		STOCKAGE STORAGE	
MH 207	BMH 7	2 - 4	400	2000	- 52	3									
MH 208	BMH 7	4 - 8	400	2000	- 51	3	- 50 + 100	- 65 + 125							
MH 209	BMH 7	8 - 12.4	400	2000	- 50	3									

modules microonde microwave modules

mélangeurs mixers

CONDITIONS DE MESURES TEST CONDITIONS			PUISSANCE O.L. L.O. POWER 4 mW		I.F. = 30 MHz		CHARGE I.F. I.F. LOAD 125 Ω		CONDITIONS LIMITES LIMITING CONDITIONS			
CARACTÉRISTIQUES A SPECIFICATIONS AT T = 25 °C			PERTES CONVERSION LOSS		FACTEUR DE BRUIT NOISE FIGURE		DÉCOUPLAGE O.L. L.O. ISOLATION		R.O.S. V.S.W.R.		TEMPÉRATURES °C TEMPERATURES °C	
TYPE TYPE	BOITIER CASE	BANDE PASSANTE BANDWIDTH GHz	dB max	dB max	dB min	dB max			FONCTION. OPERATING	STOCKAGE STORAGE		
MH 421	BMH 35 b	8.2 - 9	6	7	15	2						
MH 422	BMH 35 b	8.9 - 9.8	6	7	15	2			- 40 + 70		- 55 + 100	
MH 423	BMH 35 b	9.5 - 10.5	6	7	15	2						

mélangeurs symétriques balanced mixers

CARACTÉRISTIQUES A SPECIFICATIONS AT T = 25 °C			FACTEUR DE BRUIT (2) NOISE FIGURE		DÉCOUPLAGE O.L. L.O. ISOLATION		R.O.S. O.L. L.O. V.S.W.R.		R.O.S. H.F. R.F. V.S.W.R.		PUISSANCE O.L. L.O. POWER		TEMPÉRATURES °C TEMPERATURES °C		
TYPE TYPE	DIMENSIONS (1) DIMENSIONS mm	BANDE DE FRÉQUENCE FREQUENCY RANGE MHz	dB max	dB typ	dB	dB	dBm typ					FONCTION. OPERATING	STOCKAGE STORAGE		
F 56616	42 x 25 x 7	3700 - 4200	7	17	2	2	5								
F 56657	42 x 25 x 7	4400 - 5000	7.5	15	1.7	1.7	5								
F 56655	42 x 25 x 7	5400 - 5900	8	15	2	2	5								
F 56626	28.5 x 20 x 13	8500 - 9600	7.2	15	2	2	5								
AD 6771	25 x 18 x 7	9200 - 9500	8	15	2	2	5					- 35 + 70		- 55 + 100	
F 56658	28.5 x 20 x 13	9800 - 10400	7.5	17	2	2	5								
F 56638	28.5 x 20 x 13	10700 - 11700	7.2	20	1.7	1.7	6								
F 56641	28.5 x 20 x 13	11700 - 12700	7.2	15	2	2	5								
F 56619	28.5 x 20 x 13	12700 - 13200	7.5	15	2	2	7								
F 56621	28.5 x 20 x 13	16200 - 16400	8	17	2	2	5								

(1) Connecteur SMA
SMA Connector

(2) FI = 30 MHz - facteur de bruit : 1.5 dB (amplificateur)
IF = 30 MHz - SSB noise figure : 1.5 dB (amplifier)

mélangeurs symétriques doubles, large bande broadband double-balanced mixers

CARACTÉRISTIQUES A SPECIFICATIONS AT T = 25 °C			PERTES CONVERSION LOSS		DÉCOUPLAGE O.L. L.O. ISOLATION		PUISSANCE O.L. L.O. POWER		ENTRÉE HF RF INPUT (- 1 dB comp.)		TEMPÉRATURES °C TEMPERATURES °C	
TYPE TYPE	BOITIER CASE DIMENSIONS DIMENSIONS mm	BANDE DE FRÉQUENCE FREQUENCY RANGE MHz	dB max	dB typ	dB	dB	dBm typ	dBm typ			FONCTION. OPERATING	STOCKAGE STORAGE
NIVEAU STANDARD STANDARD LEVEL												
F 56627	BMH 158	0.2 - 200	8	30	7	3						
F 56662	BMH 160	0.5 - 500	8.5	25	7	3						
F 56633	BMH 159	1 - 1000	8.5	20	7	3						
F 56628	TO 5	5 - 300	8	20	7	3					- 55 + 100	- 55 + 100
F 56632	BMH 159	5 - 1250	8.5	20	7	3						
F 56650	BMH 157	5 - 1250	9	20	7	1						
F 56663	BMH 156	5 - 1500	8.5	20	7	1						
F 56630*	20 x 28 x 60	10 - 300	9	20	7	1					- 55 + 85	- 55 + 85
F 56631	BMH 158	10 - 500	8	25	7	3						
F 56623	BMH 160	10 - 1000	8	20	7	1					- 55 + 100	- 55 + 100
AD 6792	BMH 158	20 - 450	8	25	7	1						
F 56660	BMH 160	1000 - 2000	8	20	7	1						
HAUT NIVEAU HIGH LEVEL												
F 56624	BMH 160	10 - 3000	9	20	13	7					- 55 + 100	- 55 + 100
F 56600*	20 x 28 x 60	750 - 1500	7	25	10	1					- 55 + 85	- 55 + 85
TRÈS HAUT NIVEAU VERY HIGH LEVEL												
F 56635	BMH 158	0.2 - 200	8	25	17	10						
F 56651	BMH 163	0.5 - 500	8.5	25	23	17					- 55 + 100	- 55 + 100
F 56636	BMH 158	10 - 500	8.5	20	17	10						

* connecteur SMA * SMA connector - Autres boîtiers sur demande - Other cases on request

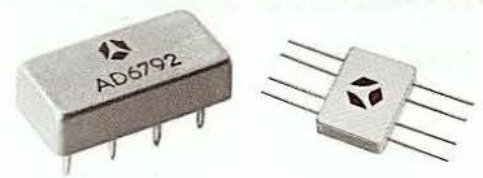

AD 6792

F 53008 A

mélangeurs à réjection de fréquence image image reject mixers

CARACTÉRISTIQUES A SPECIFICATIONS AT		T = 25 °C		FACTEUR DE BRUIT NOISE FIGURE	DÉCOUPLAGE O.L. L.O. ISOLATION	R.O.S. H.F. R.F. V.S.W.R.	REJECTION D'IMAGE IMAGE REJECTION	TEMPÉRATURES °C TEMPERATURES °C	
TYPE TYPE	BOITIER CASE	BANDE DE FRÉQUENCE FREQUENCY RANGE MHz	dB max	dB typ	max	dB typ	FONCTION OPERATING	STOCKAGE STORAGE	
F 56135	★	3700 - 4200	6 (1)	20	2	20			
F 56133	★	5900 - 6400	6 (1)	20	2	20			
F 56643 A	★	8800 - 9500	6 (2)	17	2	17			- 35 + 70
F 56643	★	9300 - 9500	6 (2)	20	2	20			- 55 + 100

* Nous consulter - please refer to THOMSON-CSF

(1) FI = 70 MHz - facteur de bruit : 1.5 dB (amplificateur)
IF = 70 MHz - SSB noise figure : 1.5 dB (amplifier)(2) FI = 30 MHz - facteur de bruit : 1.5 dB (amplificateur)
IF = 30 MHz - SSB noise figure : 1.5 dB (amplifier)

diviseurs de puissance power dividers

CARACTÉRISTIQUES A SPECIFICATIONS AT		T = 25 °C		PERTES INSERTION LOSS	DÉCOUPLAGE ISOLATION	DÉSÉQUILIBRE EN AMPLITUDE AMPLITUDE BALANCE	DÉSÉQUILIBRE EN PHASE PHASE BALANCE	R.O.S. V.S.W.R.	TEMPÉRATURES °C TEMPERATURES °C
TYPE TYPE	BOITIER CASE	VOIES WAYS	BANDE DE FRÉQUENCE FREQUENCY RANGE MHz	dB max	dB typ	dB max	DEGRÉS DEGREES max	max	FONCTION OPERATING
F 54700	BMH 153	4	20 - 1800	1.5	20	1	10	1.8	
F 54709	BMH 162	2	1 - 200	0.5	30	0.1	1	1.2	
F 54701	BMH 162	2	25 - 500	0.6	25	0.2	2	1.3	
F 54702	BMH 162	2	25 - 1500	1.8	25	0.3	5	2.2	- 55 + 85

coupleurs hybrides 90° 90° hybrids

CARACTÉRISTIQUES A SPECIFICATIONS AT		T = 25 °C		PERTES INSERTION LOSS	DÉCOUPLAGE ISOLATION	TOLÉRANCE SUR DÉPHASAGE QUADRATURE DEVIATION	DÉSÉQUILIBRE EN AMPLITUDE AMPLITUDE BALANCE	R.O.S. V.S.W.R.	LINÉARITÉ DE PHASE PHASE LINEARITY	PUISSANCE D'ENTRÉE INPUT POWER	TEMPÉRATURES °C TEMPERATURES °C
TYPE TYPE	BOITIER CASE	BANDE DE FRÉQUENCE FREQUENCY RANGE MHz	dB typ	dB min	DEGRÉS DEGREES typ	dB max	max	DEGRÉS DEGREES typ	CW W	CRÊTE PEAK W	FONCTION OPERATING
F 53008 A	BMH 161	20 - 40	0.5	20	± 2	0.75	1.2	± 3	5		
F 53008 B	BMH 161	40 - 80	0.5	20	± 2	0.75	1.2	± 3	5		
F 53008 C	BMH 161	80 - 160	0.75	20	± 3	1	1.3	± 4	4		
F 53008 D	BMH 161	100 - 200	0.75	20	± 3	1	1.3	± 4	4		- 55 + 85
F 33033	BMH 164	225 - 400	0.25	20	± 2	1	1.2		100	1000	
F 33036	BMH 165	440 - 880	0.30	20	± 3	1	1.3		100	1000	

modules microonde microwave modules

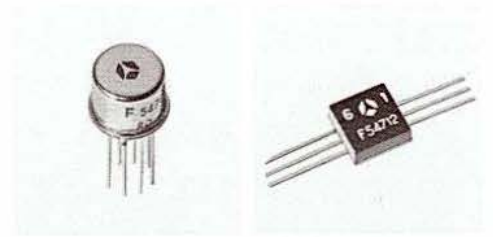

F 54706

F 54712

transformateurs large bande broadband impedance transformers

CARACTÉRISTIQUES A SPECIFICATIONS AT			BANDE DE FRÉQUENCE FREQUENCY RANGE			$\frac{Z_p^{**}}{Z_s}$	$P_{rf\ max}$	POIDS WEIGHT	TEMPÉRATURES °C TEMPERATURES °C	
TYPE TYPE	BOITIER CASE	POINT MILIEU CENTER TAPPED	PERTES INSERTION LOSS			$\frac{\Omega}{\Omega}$	mW eff.	g	FONCTION OPERATING	STOCKAGE STORAGE
			3dB	2 dB	1 dB					
F 54704	TO 5	NON NO	0.015 - 600	0.02 - 400	0.05 - 200	$\frac{50}{25}$	250	1		
F 54705	TO 5	NON NO	0.15 - 400	0.35 - 200	2 - 50	$\frac{50}{50}$	250	1		
F 54706	TO 5	OUI YES	0.2 - 350	0.35 - 300	2 - 100	$\frac{50}{200}$	250	1	- 55 + 100	- 55 + 100
F 54707	TO 5	NON NO	0.15 - 200	0.3 - 150	2 - 40	$\frac{50}{450}$	250	1		
F 54708	TO 5	OUI YES	0.3 - 120	0.7 - 80	2 - 50	$\frac{50}{800}$	250	1		
F 54710	BMH 154*	NON NO	0.015 - 600	0.02 - 400	0.05 - 200	$\frac{50}{25}$	250	0.5		
F 54711	BMH 154*	NON NO	0.15 - 400	0.35 - 200	2 - 50	$\frac{50}{50}$	250	0.5		
F 54712	BMH 154*	OUI YES	0.2 - 350	0.35 - 300	2 - 100	$\frac{50}{200}$	250	0.5	- 20 + 85	- 20 + 85
F 54713	BMH 154*	NON NO	0.15 - 200	0.3 - 150	2 - 40	$\frac{50}{450}$	250	0.5		
F 54714	BMH 154*	OUI YES	0.3 - 120	0.7 - 80	2 - 50	$\frac{50}{800}$	250	0.5		

* Boîtier plastique
* Plastic case

** Z_p impédance au primaire - primary impedance
** Z_s impédance au secondaire - secondary impedance

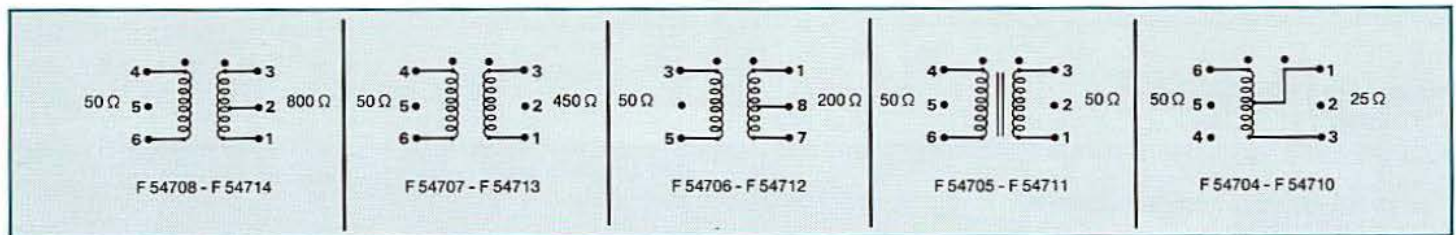

modules TO 8 TO 8 modules



oscillateurs accordables par varactor varactor tuned oscillators

CARACTÉRISTIQUES A T = 25 °C - SPECIFICATION AT 25 °C

TYPE TYPE	BOITIER CASE	GAMME DE FREQUENCE FREQUENCY RANGE		PUISSANCE DE SORTIE OUTPUT POWER	VARIATION DE LA PUISSANCE OUTPUT POWER VARIATION	DÉRIVE EN FRÉQUEN. FREQUEN. DRIFT	PULLING R.O.S PULLING V.S.W.R	PUSHING PUSHING	TAUX D'HARMO- NIQUES HARMONICS	TENSION D'ACCORD (f min → f max) TUNING VOLTAGE (f min → f max)		CAPACITÉ D'ENTRÉE INPUT CAPACITAN.	ALIMENTATION DC POWER		BRUIT FM* FM NOISE
		MHz	dBm							dB	MHz		MHz	MHz/V	
F 57534 A	TO 8-144	260 - 350	13	± 1	12	25	10	15	1	15	80	15	40	- 60	
F 57534	"	300 - 500	12	± 1	12	25	10	15	1	15	80	15	40	- 60	
F 57535	"	400 - 600	12	± 1	15	25	10	15	1	15	80	15	40	- 60	
F 57525 A	"	480 - 770	10	± 1	12	15	10	15	1.5	20	80	12	45	- 60	
F 57515 A	"	600 - 810	12	± 1	12	15	10	15	1.5	20	80	12	45	- 60	
F 57510	"	600 - 1000	12	± 1	12	15	10	15	1.5	30	80	12	45	- 60	
F 57523 A	"	780 - 1080	12	± 1	20	10	10	17	1.5	20	80	12	45	- 60	
F 57516	"	800 - 1200	12	± 1	18	15	10	15	1.5	20	80	12	45	- 60	
F 57524	"	800 - 1425	12	± 1	20	20	10	15	1.5	30	80	12	45	- 60	
F 57511	"	900 - 1600	12	± 1	15	25	10	13	1.5	40	80	12	45	- 60	
F 57527	"	960 - 1215	13	± 1	25	25	10	15	2	10	80	12	45	- 60	
F 57517	"	1100 - 1800	12	± 1	30	30	15	15	1.5	45	80	12	45	- 60	
F 57518	"	1300 - 1500	12	± 1	12	15	10	15	1.5	20	80	12	45	- 60	
F 57520	"	1500 - 2000	12	± 1	20	15	10	15	1.5	15	80	12	45	- 60	
F 57512	"	1600 - 2500	12	± 1	25	30	15	15	1.5	30	80	12	45	- 60	
F 57529	"	2100 - 2600	12	± 1	35	50	15	15	1.5	20	80	12	45	- 60	
F 57526	"	2700 - 3200	12	± 1	30	50	20	17	1.5	10	80	12	45	- 60	
F 57528	"	2800 - 3500	12	± 1	50	100	25	15	1.5	20	80	12	45	- 60	
F 57538	"	4200 - 4400	10	± 1	40	60	25	17	2	10	80	12	45	- 60	
F 57531	TO 8-155	6000 - 6500	10	± 1	1 MHz/°C	80	25	25	non accordable no tuning		80	12	45	- 60	

* dans 1 KHz de bande, à 50 KHz de la porteuse - SSB FM NOISE in 1 KHz B.W. and 50 KHz from carrier

amplificateurs cascadables cascadable amplifiers

CARACTÉRISTIQUES A T = 25 °C - SPECIFICATIONS AT T = 25 °C

TYPE TYPE	BOITIER CASE	BANDE PASSANTE BANDWIDTH	GAIN EN PUISSANCE MIN MIN POWER GAIN	ONDULATION DU GAIN GAIN FLATNESS	VARIATION DU GAIN -40+110°C GAIN VARIATION -40+110°C	FACTEUR DE BRUIT MAX MAX NOISE FIGURE		PUISSANCE DE SORTIE (-1dB COMPRES. GAIN) POWER OUTPUT (-1dB GAIN COMPRESSION)	POINT D'INTERSECTION INTERCEPT. POINT typ	R.O.S ENTRÉE/ SORTIE V.S.W.R INPUT/ OUTPUT	ALIMENTATION DC POWER	
						T=25°C	T=-40+110°C				dBm	dBm
F 56341	TO 8-144	1 - 150	13	± 0.5	± 0.5	8		+ 17		2	15	65
F 56342	"	1 - 250	14	± 1	± 1	5.5	7	+ 7	+ 21	2	15	30
F 56342 B	"	1 - 250	15	± 1	± 1	5.5	7	+ 7	+ 21	2	15	30
F 56341 B	"	1 - 800	13	± 1	± 1	8		+ 17		2	15	65
F 56334	"	5 - 500	16	± 1	± 1	5.5	7	+ 7	+ 21	2	12	24
F 56335	"	5 - 1000	8	± 1.3	±			+ 18	+ 34	2.2	15	75
F 56335 A	"	5 - 1000	10	± 1.3	± 1	8		+ 18	+ 34	2.2	15	75
F 56336 A	"	5 - 1000	14	± 1	± 1	4	5.5	+ 2	+ 15	2	12	17
F 56337 A	"	5 - 1000	13	± 1	± 1	5.5	7	+ 7	+ 21	2	12	24
F 56338 A	"	5 - 1000	13	± 1	± 1	7.5	8.5	+ 14	+ 29	2	12	36
F 56336	"	100 - 1100	14	± 1	± 1	4.5	5.5	+ 2	+ 15	2	12	17
F 56337	"	100 - 1100	13	± 1	± 1	5.5	7	+ 7	+ 21	2	12	24
F 56338	"	100 - 1100	13	± 1	± 1	7.5	8.5	+ 14	+ 29	2	12	36
F 56344	"	1000 - 1400	8	± 1	± 1		12	+ 17	+ 33	2.2	12	75
F 56345	"	1000 - 1400	12	± 1	± 1		8.5	+ 14	+ 28	2	12	42
F 56346	"	1000 - 1400	11	± 1	± 1		7	+ 7	+ 20	2	12	26
F 56347 A	"	1000 - 1400	11	± 1	± 1		6	+ 2	+ 15	2	12	17
T = -40 + 80°C												
F 56358 B	TO 8-155	1 - 600	11	± 0.3	± 0.5	2.2	3	0	+ 20	2	10	5
F 56358	"	10 - 800	10	± 0.5	± 0.5	3	3.5	+ 2	+ 20	2	12	10

modules TO 8 TO 8 modules



TH 5278

atténuateurs commandés en tension voltage controlled attenuators

CARACTÉRISTIQUES A T = 25°C - SPECIFICATIONS AT T = 25°C

TYPE TYPE	BOITIER CASE	BANDE DE FRÉQUENCE FREQUENCY RANGE	PERTES INSERTION LOSS		MIN ATTÉNUATION MIN. ATTENUATION		R.O.S V.S.W.R		TENSION/COURANT DE COMMANDE CONTROL POWER		ALIMENTATION DC POWER		VARIATION DES PERTES D'INSERTION POUR UNE ATTÉNUATION DE 15 dB INSERTION LOSSES VARIATION AT 15 dB OF ATTENUATION			
			typ	max	typ	min	typ	max	V	mA	V	mA	EN TEMPÉRATURE WITH TEMPERATURE		EN FRÉQUENCES WITH FREQUENCY	
		MHz	dB		dB								40°C		-40°C	
			typ max		typ min								+100°C		+115°C	
F 57102	TO 8-125	1 - 150	1.5	2	25	20	1.5	2	0 - 12	5	12	12	± 0.5	± 1	± 0.5	± 1
F 57101		100 - 1100	1.5	2	25	20	1.5	2	0 - 12	5	12	12	± 0.5	± 1	± 0.5	± 1
F 57104		960 - 1215	1.5	2	25	20	1.5	2	0 - 12	5	12	12	± 0.5	± 1	± 0.5	± 1

limiteurs commandés en tension voltage controlled limiters

CARACTÉRISTIQUES A T = 25°C - SPECIFICATIONS AT T = 25°C

TYPE TYPE	BOITIER CASE	BANDE DE FRÉQUENCE FREQUENCY RANGE	PUISSANCE D'ENTRÉE max MAX INPUT POWER	PUISSANCE CRÊTE (3 µs max) MAX PEAK POWER (3 µs max) dBm	PERTES POLARISATION (7 V) INSERTION LOSS BIAS (7 V)	NIVEAU DE SORTIE OUTPUT LEVEL	TEMPS DE RÉCUPÉRATION RECOVERY TIME	NIVEAU D'HARMONIQUE 2 (1 dB COMPRESSION) 2nd ORDER HARMONIC (1 dB COMPRESSION)
F 57903	TO 8 - 144	1 - 150	25	30	3.5	0 (+ 20 V) - 10 (+ 5 V)	60	30
F 57902		100 - 1100	25	30	3.5	0 (+ 20 V) - 10 (+ 5 V)	60	30

lignes à retard à onde de volume BAW delay lines

CARACTÉRISTIQUES A T = 25°C - SPECIFICATIONS AT T = 25°C

TYPE TYPE	* BOITIER CASE	FRÉQUENCE FREQUENCY MHz	BANDE PASSANTE BANDWIDTH MHz	RETARD DELAY µs	PERTES D'INSERTION INSERTION LOSS dB max	R.O.S V.S.W.R
F 5417	TO 8	1400	600	7	50	
F 527R		4300	200	0.61	50	< 2

* Nous consulter - Please refer to THOMSON-CSF

composants optiques
optical components

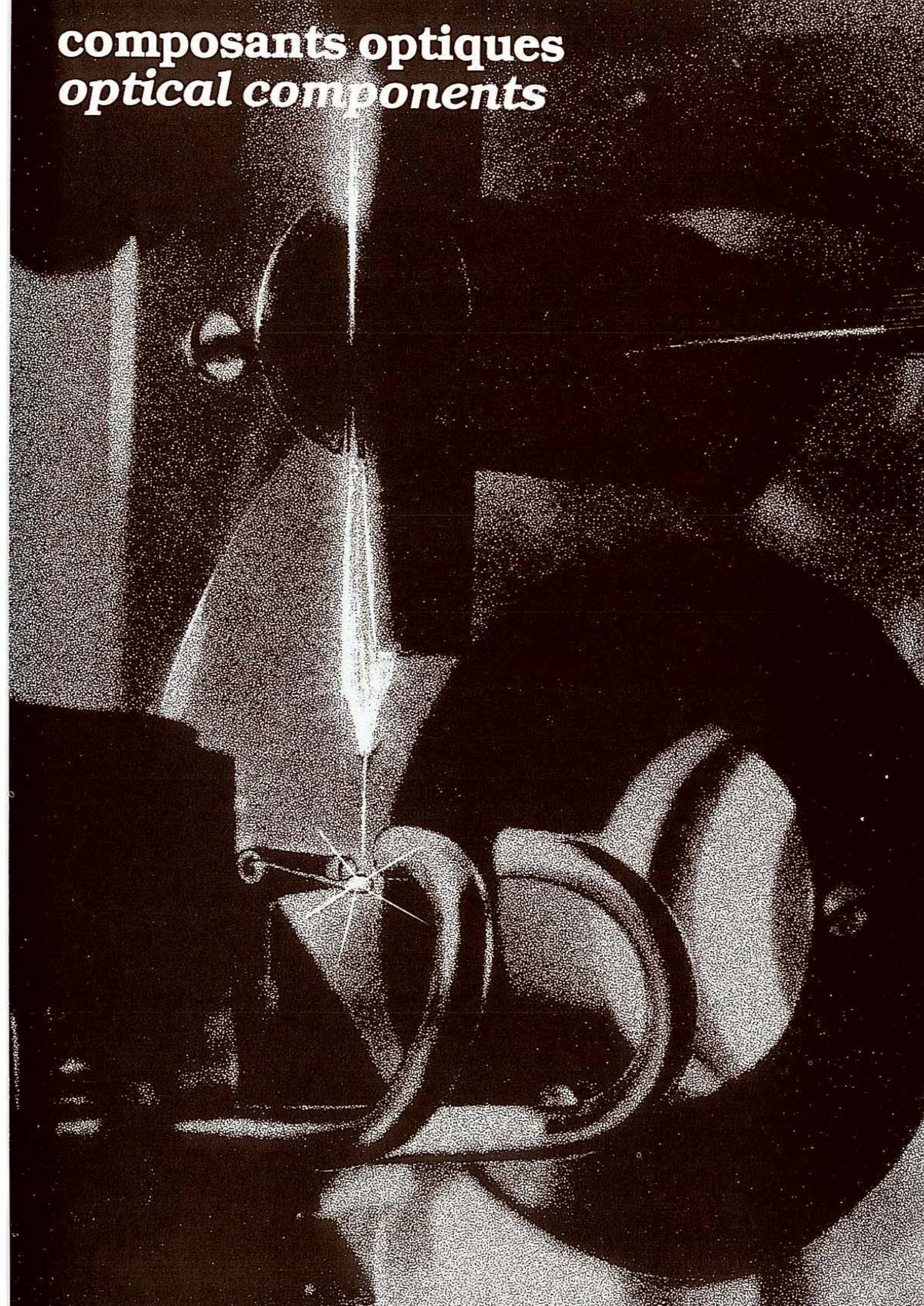

Pour répondre au développement des communications optiques, la Division Composants Microonde de THOMSON-CSF propose deux grandes familles de composants optiques :

- Les DEL et les photodiodes PIN sont disponibles sous trois types de conditionnement :
 - capots standard à fenêtre pour liaisons en espace libre ou utilisation avec divers connecteurs.
 - configurations barreau, lisse, avec connecteurs SMA ou miniature à vis, pour réalisation de connexions performantes et reproductibles.
 - boîtiers métalliques pour les émetteurs et récepteurs analogiques et numériques, avec interfaces incorporées.
 - Les dispositifs à diode laser sont disponibles sous deux types de conditionnement :
 - tête optique en configuration "connecteur" ou "fibre amorcée". Outre la diode laser, une tête optique comporte une fibre intermédiaire de couplage et des senseurs permettant de contrôler la puissance de sortie et la température.
 - émetteur à diode laser en configuration "connecteur" ou "fibre amorcée". L'émetteur est constitué d'une tête optique associée à une électronique de contrôle.
- Une grande maîtrise des technologies assure d'excellentes caractéristiques de durée de vie. Les diodes DEL dépassent en durée de vie moyenne 10^6 heures et les diodes laser 100.000 heures.

THOMSON-CSF Microwave Component Division has two large families of optical components available to meet the needs of optical communication development.

- LED's and PIN photodiodes are available with three types of cases :
 - standard window cases for free space links or for use with various connectors.
 - smooth rod type configurations with SMA or screw-fitted subminiaturized connector for high performance and reproducible connections.
 - metal case for digital and analog receivers and transmitters, (interface incorporated).
 - Laser diode devices are available in two types of cases :
 - optical head in connector or pigtail configuration. Beside the laser diode, an optical head includes sensors and intermediate coupling fiber, permitting temperature and output power control.
 - laser diode transmitter in connector or pigtail configuration. The transmitter comprises an optical head associated with an electronic control system.
- Our technology expertise ensures long life characteristics. The lifetime of LED diodes exceeds 10^6 hours, and that of laser diodes 100.000 hours.

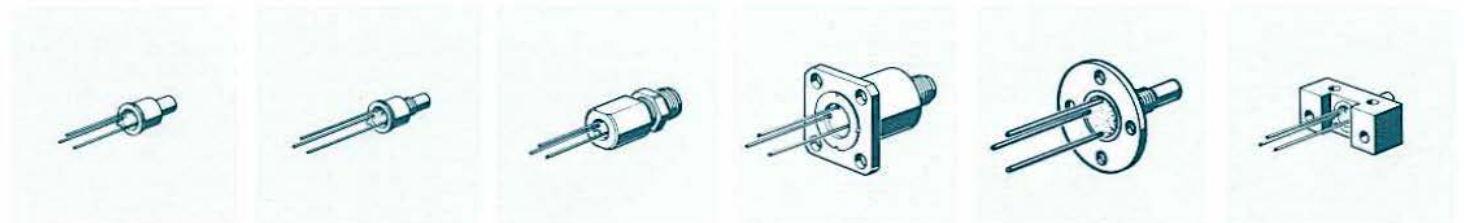

BH 107

BH 109

BH 108

BH 110

BH 111

BH 112

composants optiques optical components



BH 105 a

BH 104 a

BH 106

émetteurs à DEL. éléments discrets LED emitters, discrete devices

CARACTÉRISTIQUES A SPECIFICATIONS AT		T = 25 °C		SORTIE OPTIQUE OPTICAL OUTPUT					CONDITIONS LIMITES LIMITING CONDITIONS		
TYPE TYPE (1)	BOITIER CASE	CONNECTEUR CONNECTOR	DIAMÈTRE DE LA SURFACE ÉMISSIVE EMITTING AREA DIAMETER	OUVERTURE NUMÉRIQUE NUMERICAL APERTURE (1)	LONGUEUR D'ONDE WAVE LENGTH	PUISSANCE OPTIQUE OPTICAL POWER I _c = 50 mA		TEMPS DE MONTÉE RISETIME		COURANT CONTINU DIRECT MAX. FORWARD D.C. CURRENT	TEMPÉRATURES °C TEMPERATURES °C
						μW min	μW typ	ns min	ns typ		
SE 100	BH 105a		180		840	800	900	10	15		
SE 101	BH 104a		180		840	1000	1200	10	15		
SE 110	BH 106c		570	0.57	840	250	400	10	15		
SE 111	BH 106b		350	0.57	840	250	400	10	15		
SE 112	BH 106a		180	0.57	840	200	350	10	15		
SE 210	BH 106b		350	0.57	840	450	550	10	15		
SE 211	BH 106b		350	0.57	840	400	500	6	8		
SE 212	BH 106a		180	0.57	840	450	550	10	15		
SE 213	BH 106a		180	0.57	840	200	350	6	8		
SE 113	BH 107c		570	0.57	840	250	400	10	15		
SE 114	BH 107b		350	0.57	840	250	400	10	15		
SE 115	BH 107a		180	0.57	840	200	350	10	15		
SE 214	BH 107b		350	0.57	840	450	550	10	15		
SE 215	BH 107b		350	0.57	840	400	500	6	8		
SE 216	BH 107a		180	0.57	840	450	550	10	15		
SE 217	BH 107a		180	0.57	840	200	350	6	8		
SE 120	BH 109c		570	0.57	840	250	400	10	15		
SE 121	BH 109b		350	0.57	840	250	400	10	15		
SE 122	BH 109a	COMPATIBLE SÉRIE 7201 (SOCAPEX)	180	0.57	840	200	350	10	15		
SE 220	BH 109b		350	0.57	840	450	550	10	15		
SE 221	BH 109b		350	0.57	840	400	500	6	8		
SE 222	BH 109a		180	0.57	840	450	550	10	15		
SE 223	BH 109a		180	0.57	840	200	350	6	8		
SE 123	BH 108c		570	0.57	840	250	400	10	15		
SE 124	BH 108b		350	0.57	840	250	400	10	15		
SE 125	BH 108a	COMPATIBLE KMR-SMA (SYCEP)	180	0.57	840	200	350	10	15	110	0 + 70
SE 224	BH 108b		350	0.57	840	450	550	10	15		
SE 225	BH 108b		350	0.57	840	400	500	6	8		
SE 226	BH 108a		180	0.57	840	450	550	10	15		
SE 227	BH 108a		180	0.57	840	200	350	6	8		
SE 143	BH 110c		570	0.57	840	250	400	10	15		
SE 144	BH 110b		350	0.57	840	250	400	10	15		
SE 145	BH 110a		180	0.57	840	200	350	10	15		
SE 244	BH 110b	KMR-SMA (SYCEP)	350	0.57	840	450	550	10	15		
SE 245	BH 110b		350	0.57	840	400	500	6	8		
SE 246	BH 110a		180	0.57	840	450	550	10	15		
SE 247	BH 110a		180	0.57	840	200	350	6	8		
SE 146	BH 111b		350	0.57	840	250	400	10	15		
SE 147	BH 111a		180	0.57	840	200	350	10	15		
SE 148	BH 112b		350	0.57	840	250	400	10	15		
SE 149	BH 112a		180	0.57	840	200	350	10	15		
SE 150	BH 112c		570	0.57	840	250	400	10	15		
SE 155	BH 111c		570	0.57	840	250	400	10	15		
SE 153	BH 112a	COMPATIBLE SÉRIE 7201 (SOCAPEX)	180	0.57	840	450	550	10	15		
SE 158	BH 111a		180	0.57	840	450	550	10	15		
SE 154	BH 112a		180	0.57	840	200	350	6	8		
SE 159	BH 111a		180	0.57	840	200	350	6	8		
SE 151	BH 112b		350	0.57	840	450	550	10	15		
SE 156	BH 111b		350	0.57	840	450	550	10	15		
SE 152	BH 112b		350	0.57	840	400	500	6	8		
SE 157	BH 111b		350	0.57	840	400	500	6	8		

(1) Mesure à $\frac{P_1}{2}$ - $\frac{P_2}{2}$ Measurement.

(2) Polarité inversée : suffixe R
Reverse polarity : R suffix

Remarque :
Préfixe SE pour les dispositifs émetteurs
Préfixe SR pour les dispositifs récepteurs

NOTE :
SE prefix for transmitting devices
SR prefix for receiving devices

composants optiques optical components



BMH 125 - BMH 126



BH 105a



BH 104a

émetteurs-récepteurs analogiques analog transmitters-receivers

CARACTÉRISTIQUES A SPECIFICATIONS AT			T = 25 °C		BANDE PASSANTE (- 3 dB) BANDWIDTH (- 3 dB)	INTERFACE ELECTRIQUE ELECTRICAL INTERFACE	LONGUEUR D'ONDE WAVELENGTH	PUISSANCE (1) OPTIQUE COUPLÉE COUPLED OPTICAL POWER	TYPE DE MODULATION TYPE OF MODULATION	PUISSANCE (2) OPTIQUE RECUE RECEIVED OPTICAL POWER	RAPPORT (2) SIGNAL/ BRUIT S/N RATIO	TENSION D'ALIMEN- TATION SUPPLY VOLTAGE	TEMPÉRATURES °C TEMPERATURES °C	
TYPE TYPE	BOITIER CASE	CONNECTEUR CONNECTOR	H _z / MHz	V CRÊTE-CRÊTE PEAK TO PEAK max	nm typ	dBm typ	dBm typ	dB typ	dB typ	V typ.	FONCTION. OPERATING	STOCKAGE STORAGE		
SE 500	BMH 125	SOCAPEX 7201	30/30	0.2/50 Ω	840	- 14		AM (100 %)		+ 6/- 6	0 + 70	- 15 + 100		
SR 500	BMH 125		30/30	1.6/50 Ω	840			- 23	37	+ 6/- 6				
SE 501	BMH 126	KMR/SMA (SYCEP)	30/30	0.2/50 Ω	840	- 14		AM (100 %)		+ 6/- 6				
SR 501	BMH 126		30/30	1.6/50 Ω	840			- 23	37	+ 6/- 6				

(1) Puissance optique moyenne couplée dans une fibre à saut d'indice (φ_c = 200 μm)
Mean optical power coupled in a step index optical fiber (φ_c = 200 μm)

(2) Pour un gain global de liaison de 1.
Total link gain = 1.

émetteurs-récepteurs numériques digital transmitters-receivers

CARACTÉRISTIQUES A SPECIFICATIONS AT			T = 25 °C		DEBIT DATA RATE	INTERFACE ELECTRIQUE ELECTRICAL INTERFACE	LONGUEUR D'ONDE WAVELENGTH	PUISSANCE (1) OPTIQUE COUPLÉE COUPLED OPTICAL POWER	TYPE DE MODULATION TYPE OF MODULATION	PUISSANCE (2) OPTIQUE RECUE RECEIVED OPTICAL POWER	BANDE PASSANTE MINIMUM DU CABLE OPTIQUE MINIMUM BAND- WIDTH OF THE OPTICAL CABLE	TENSION D'ALIMEN- TATION SUPPLY VOLTAGE	TEMPÉRATURES °C TEMPERATURES °C	
TYPE TYPE	BOITIER CASE	CONNECTEUR CONNECTOR	Mbit/s	nm typ	dBm typ	dBm typ	MHz min	V typ	FONCTION. OPERATING	STOCKAGE STORAGE				
SE 554	BMH 125	SOCAPEX 7201	DC - 5	TTL	840	- 14	FSK	10	+ 5	0 + 60				
SR 554	BMH 125		DC - 5	TTL	840		FSK	- 38	10		+ 5			
SE 555	BMH 126	KMR/SMA (SYCEP)	DC - 5	TTL	840	- 14	FSK	10	+ 5					
SR 555	BMH 126		DC - 5	TTL	840		FSK	- 38	10		+ 5			

(1) Puissance optique moyenne couplée dans une fibre à saut d'indice (φ_c = 200 μm)
Mean optical power coupled in a step index optical fiber (φ_c = 200 μm)

(3) Puissance moyenne pour un taux d'erreur de 10⁻⁸
Mean optical power (error rate 10⁻⁸)

récepteurs à diodes PIN, éléments discrets PIN diodes receivers, discrete devices

CARACTÉRISTIQUES A SPECIFICATIONS AT			T = 25 °C		ENTRÉE OPTIQUE OPTICAL INPUT			CONDITIONS LIMITES LIMITING CONDITIONS		
TYPE TYPE	BOITIER CASE	CONNECTEUR CONNECTOR	DIAMÈTRE DE LA SURFACE DÉTECTRICE DETECTING AREA DIAMETER	OUVERTURE NUMÉRIQUE NUMERICAL APERTURE	COEFFICIENT DE RÉPONSE A 840 nm SENSITIVITY AT 840 nm	TEMPS DE MONTÉE RISETIME	COURANT D'OBSCURITÉ - 10 V DARK CURRENT - 10 V	CAPACITÉ - 10 V CAPACIT. - 10 V	TENSION VOLTAGE	TEMPÉRATURES °C TEMPERATURES °C
			μm		μA/μW	ns	nA max	pF max	V max	FONCTION OPERATING
SR 100	BH 105 a		900		0.4	1	5	5	50	
SR 101	BH 104 b		900		0.4	1	5	5	50	
SR 110	BH 106 c		570	0.57	0.4	1	5	5	50	
SR 111	BH 107 c		570	0.57	0.4	1	5	5	50	
SR 120	BH 109 c	COMP. 7201 (SOCAPEX)	570	0.57	0.4	1	5	5	50	
SR 121	BH 108 c	COMP. KMR-SMA (SYCEP)	570	0.57	0.4	1	5	5	50	0 + 70
SR 141	BH 110 c	KMR-SMA (SYCEP)	570	0.57	0.4	1	5	5	50	
SR 142	BH 111 c	COMP. 7201 (SOCAPEX)	570	0.57	0.4	1	5	5	50	
SR 143	BH 112 c	COMP. 7201 (SOCAPEX)	570	0.57	0.4	1	5	5	50	

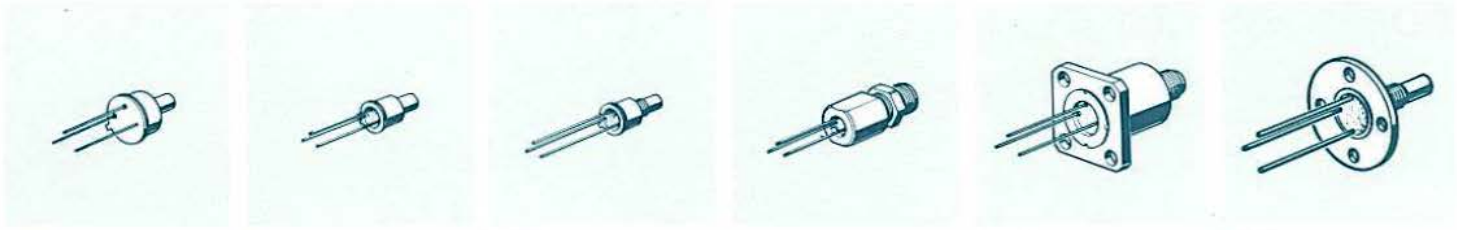

BH 106 BH 107 BH 109 BH 108 BH 110 BH 111

émetteurs à diode laser
laser diode emitters

CONDITIONS DE MESURES TEST CONDITIONS		T = + 25 °C		I _{th} + 15 mA			15° < T < 45 °C			CONDITIONS LIMITES LIMITING CONDITIONS							
CARACTÉRISTIQUES A SPECIFICATIONS AT		T = 25 °C		COURANT DE SEUIL THRESHOLD CURRENT I _{th}		PUISS. OPTIQUE EN SORTIE OPTICAL OUTPUT POWER CONNECT. PIG-TAIL CONNECT.		PUISS. OPTIQUE COUPLÉE DANS LA FIBRE OPTICAL POWER FIBER COUPLED		TEMPS DE MONTÉE DANS DE DESCENTE RISE TIME AND FALL TIME		LONGUEUR D'ONDE WAVE LENGTH	RÉGULATION PUISSANCE OPTIQUE OPTICAL POWER STABILIZATION	FRÉQUENCE DE COUPEURE CUT OFF FREQUENCY (3 dB)	IMPÉDANCE E/S IMPEDANCE I/O	TENSION D'ALIMENTATION VOLTAGE SUPPLY	TEMPÉRATURES °C TEMPERATURES °C
TYPE TYPE	BOITIER CASE	CONNECTEUR CONNECTOR	mA typ	mA max	mW	mW	mW min	mW typ	mW max	ns typ	ns max	nm typ	%	MHz	Ω	V	FONCTION. OPERATING
SE 300	BH 121	PIG-TAIL	90	100		2				0.5	1	840					0 + 60
SE 301	BH 120	SÉRIE 724 (SOCAPEX)	90	100	2		1.5	1.7	2	0.5	1	840					
SE 700	BMH 121	PIG-TAIL	90	100		2				0.5	1	840	5	200	50/50	- 5	+ 15 + 45
SE 701	BMH 120	SÉRIE 724 (SOCAPEX)	90	100	2		1.5	1.7	2	0.5	1	840	5	200	50/50		
SE 350	BH 121	PIG-TAIL	90	100		3.5				0.5	1	840					0 + 60
SE 351	BH 120	SÉRIE 724 (SOCAPEX)	90	100	3.5		2.5	3	3.5	0.5	1	840					0 + 60
SE 750	BMH 121	PIG-TAIL	90	100		3.5				0.5	1	840	5	300	50/50	- 5	+ 15 + 45
SE 751	BMH 120	SÉRIE 724 (SOCAPEX)	90	100	3.5		2.5	3	3.5	0.5	1	840	5	300	50/50	- 5	+ 15 + 45
SE 400	BH 121	PIG-TAIL	90	120		1	0.6	0.8	1		2	840					0 + 60

récepteurs pour application laser
laser application receivers

CARACTÉRISTIQUES A SPECIFICATIONS AT		T = 25 °C		DIAMÈTRE FIBRE DE COUPLAGE COUPLING FIBER DIAMETER		OUVERTURE NUMÉRIQUE NUMERICAL APERTURE		SENSIBILITÉ SENSITIVITY		GAIN		TEMPS DE RÉPONSE PULSE TIME		COURANT D'OBSCURITÉ DARK CURRENT		CAPACITÉ (- 10 V) CAPACIT. (- 10 V)		CAPACITÉ (- 120 V) CAPACIT. (- 120 V)		TENSION D'ALIMENTATION VOLTAGE SUPPLY		TEMPÉRATURES °C TEMPERATURES °C		
TYPE TYPE	BOITIER CASE	CONNECTEUR CONNECTOR	μm		A/W			ns	nA	pF	pF	V											FONCTION. OPERATING	
SR 199	BH 123		580	0.57	0.4			1	≤ 5	5		10												
SR 320	BH 123	SÉRIE 724 (SOCAPEX)	180	0.57	≥ 0.2	> 100	< 0.5	≤ 5		1		170											+ 15 + 45	
SR 321	BH 123		350	0.57	≥ 0.3	> 100	2	≤ 100		2		370												
SR 322	BH 123		350	0.57	≥ 0.2	> 100	< 0.5	≤ 1.5		1.5		220												

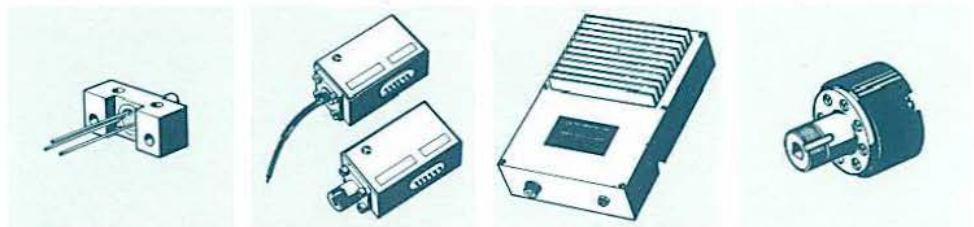

BH 112 BH 120 - BH 121 BMH 121 BH 123

lignes à retard
delay lines

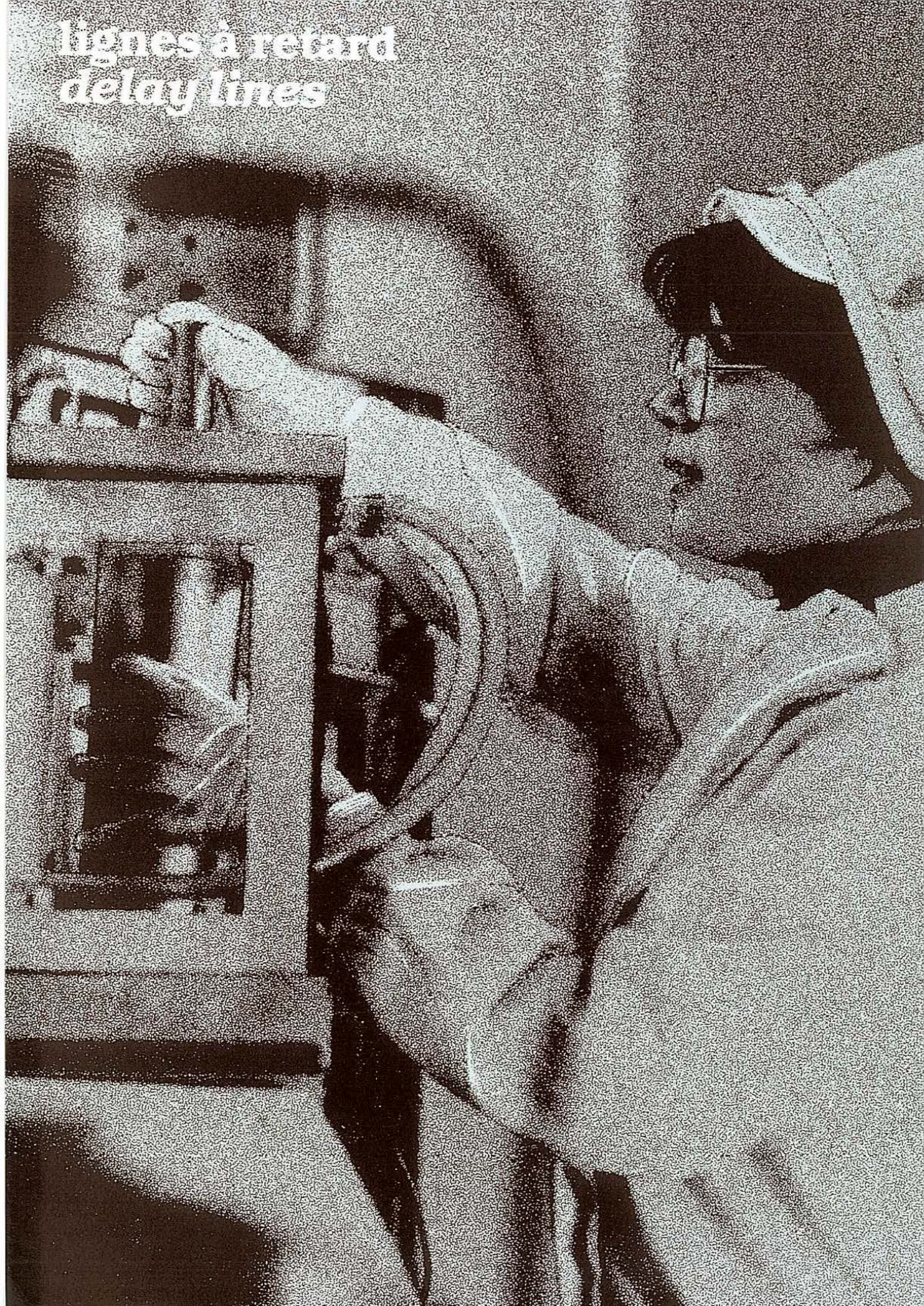

lignes à retard

La Division Composants Microonde de THOMSON-CSF a développé diverses familles de lignes à retard à ondes de volume, en transmission et en réflexion.

- Les lignes à retard conventionnelles couvrent les fréquences de 36 MHz à 10.000 MHz. Deux modèles peuvent supporter de fortes puissances en entrée. (F 5206 et TH 5219).
- Les lignes à grand retard font appel à une refocalisation de l'énergie acoustique selon un procédé de fabrication breveté pour obtenir des retards importants avec des pertes relativement faibles : on atteint ainsi 120 μ s à 1000 MHz.
- Les lignes à retard à échos multiples utilisent le même principe de refocalisation et peuvent délivrer en sortie un signal retardé et codé à partir d'un signal d'entrée : on obtient ainsi par exemple, 4 échos séparés de 20 μ s. L'ensemble de ces lignes est livré sous des encapsulations diverses. En particulier deux lignes (F 5417 et TH 5278) sont montées en boîtier TO 8 permettant de gagner un rapport 20 en poids et encombrement par rapport aux encapsulations ordinaires. Les technologies développées par la Division Composants Microonde étant très souples, les caractéristiques présentées ne sont pas limitatives. Il est ainsi possible d'étudier sur demande des lignes adaptées à des besoins particuliers. Nous consulter.

delay lines

THOMSON-CSF Microwave Component Division has developed various families of transmission and reflective bulk wave delay lines.

- *Simple fixed delay lines cover frequencies from 36 MHz to 10.000 MHz. Two models are suitable for high input powers (F 5206 and TH 5219).*
 - *Very long delay lines use acoustic energy refocalization to obtain high delays with relatively low insertion loss, using a patented manufacturing process. In this way, 120 μ s at 1000 MHz is obtained.*
 - *Multi-echo delay lines use the same refocalization principle and can supply a coded time-delayed output signal from an input signal. For instance, in this manner, four echoes at 20 μ s intervals are obtained. All these delay lines are available in different types of cases. In particular, two lines (F 5417 and TH 5278) are available in TO 8 cases providing a 1 to 20 weight gain and compactness ratio as compared to standard cases.*
- As the technologies developed by the Microwave Component Division are very flexible, the list of characteristics is not exhaustive. On request, it is possible to study delay lines meeting particular requirements. Please refer to THOMSON-CSF.*

lignes à retard à ondes de volume

BAW delay lines



F 5031

lignes à retard à onde de volume

BAW delay lines

CARACTÉRISTIQUES A T = 25°C - SPECIFICATIONS AT T = 25°C

TYPE TYPE	BOITIER CASE	FRÉQUENCE CENTRALE CENTER FREQUENCY MHz	RETARD DELAY μs	BANDE PASSANTE BANDWIDTH MHz	PERTES D'INSERTION INSERTION LOSS			R.O.S V.S.W.R max	ÉCHO TRIPLE TRIPLE TRAVEL SUPPRESSION dB typ	FUITE DIRECTE FEEDTHROUGH SUPPRESSION dB typ	MODE (1) MODE
					dB max	dB typ	dB var (2)				
TH 5281	A	36	50	9	33		3	2			T
TH 5286	B	150	12.24	25	20		3	2			R
F 5203	G 1	1060	2	60	30	23	3	5	20	20	T
TH 5208	C 2	1275	20	150	45		2	2			R
TH 5269	C 3	1300	10	130	50			2			R
TH 5285	C 4	1300	15	100	45		2	2	25	30	T
TH 5277	C 5	1310	4	120	35	33	3	2	20	60	T
F 5205 B	H 3	1325	0.45	200	35	30	3	2.5	20	20	T
F 5205 A	H 3	1325	0.56	200	35	30	3	2.5	20	20	T
F 5208	H 2	1325	1.12	200	35	30	3	2.5	20	20	T
F 5209	H 1	1325	2.45	200	35	33	3	2.5	20	20	T
F 5210	H 3	1325	4.45	200	35	33	3	2.5	20	20	T
F 5417	TO 8	1400	7	600	40	32	3	3			R
TH 5279 A	D 1	1500	0.4	900	44	40	8	3	10	25	T
TH 5206 A	C 5	1500	0.5	600	38	34	5	2	15	25	T
TH 5279 B	D 1	1500	0.8	900	44	40	8	3	12	25	T
TH 5206 B	C 5	1500	1	600	38	34.5	5	2	15	25	T
TH 5206 C	C 5	1500	1.5	600	38	35	5	2	15	25	T
TH 5279 C	D 2	1500	1.6	900	44	40	8	3	15	25	T
TH 5206 D	C 5	1500	2	600	38	35	5	2	15	25	T
TH 5207 A	C 6	1500	2.5	600	41	37	5	2	15	25	T
TH 5279 D	D 2	1500	3.2	900	44	40	8	3	15	25	T
TH 5207 B	C 6	1500	5	600	41	38	5	2	15	25	T
TH 5279 E	D 3	1500	6.4	900	44	40	8	3	15	25	T
TH 5207 D	C 6	1500	7	600	41	38	5	2	15	25	T
TH 5207 C	C 6	1500	7.5	600	41	38	5	2	15	25	T
TH 5252	C 3	1500	10	600	50	45	5	2	20	25	T
TH 5243	C 7	1730	26.6	60	70		1	2			R
TH 5227	C 2	2500	14	100	70		1	2			R
TH 5263	C 5	3000	0.5	1500	36		5	3	15	25	T
TH 5264	C 5	3000	5	1500	41		5	3	15	25	T
TH 5239	C 2	3000	10	300	60		2	2			R
F 5404 A	G 6	3050	10	500	60	55	4	5			R
F 5404 B	G 6	3050	20	500	80	70	4	5			R
TH 5228 E	C 5	3650	1.5	200	55		3	2	20	30	T
LR 501	C 8	3700	1.3	300	47	41	5	2	20	25	T
LR 502	C 8	3700	4	300	57	50	5	2	20	25	T
LR 503	C 9	3700	1.3	300	90	85	5	2	20	25	T
TH 5216 F	C 5	4300	0.5	200	40	37	3	2	15	25	T
TH 5278	TO 8	4300	0.61	200	50		3	2			R
TH 5216 G	C 5	4300	0.66	200	40	37	3	2	15	25	T
F 5039	G 4	4300	1	200	45	40	3	2.5			R
TH 5216 E	C 5	4300	1	200	50	37	3	2	15	25	T
TH 5216 J	C 5	4300	1.016	200	50	37	3	2	15	30	T
TH 5216 I	C 5	4300	1.2	200	40	37	3	2	15	25	T
LR 601	C 8	4300	1.3	300	49	45	5	2	20	25	T
TH 5213	C 5	4300	1.34	200	50		3	2	15	25	T
TH 5216 H	C 5	4300	1.805	200	40	37	3	2	20	30	T
TH 5216 D	C 5	4300	2	200	55	42	3	2	20	30	T
TH 5216 R	C 5	4300	2.032	200	55	42	3	2	20	30	T
F 5037	G 2	4300	3	200	55	50	3	2.5			R
TH 5237	F 2	4300	3.85	200	55	50	3	2	20	25	T
TH 5216 C	C 5	4300	4	200	65	50	3	2	30	30	T
LR 602	C 8	4300	4	300	59	50	5	2	20	25	T
TH 5216 L	C 5	4300	4.064	200	65	50	3	2	20	30	T
TH 5216 B	C 3	4300	6	200	75	60	3	2	30	30	T
TH 5216 M	C 5	4300	9.5	200	90	75	3	2	20	30	T
TH 5216 A	C 3	4300	10	200	95	75	3	2	30	30	T
LR 603	C 9	4300	13	300	95	90	5	2	20	25	T
TH 5221 A	D 4	10100	0.1	200	40		3	3	15	25	T
TH 5221 D	D 4	10100	0.5	200	45		3	3	15	25	T
TH 5221 G	D 4	10100	1	200	55		3	3	15	25	T

(1) T : en transmission - Transmission mode

R : en réflexion - Reflective mode

(2) Ondulation dans la bande de fréquence - Ripple in frequency range

lignes à retard à ondes de volume

BAW delay lines



TH 5216



TH 5278

lignes à retard de puissance

high power delay lines

CARACTÉRISTIQUES A $T = 25^{\circ}\text{C}$												
SPECIFICATIONS AT												
TYPE TYPE	BOITIER CASE	FRÉQUENCE CENTRALE CENTER FREQUENCY MHz	RETARD DELAY μs	BANDE PASSANTE BANDWIDTH MHz	PERTES D'INSERTIN INSERTION LOSS			R.O.S. V.S.W.R. max	ÉCHO TRIPLE TRIPLE TRAVEL SUPPRESSION dB typ	FUITE DIRECTE FEEDTHROUGH SUPPRESSION dB typ	MODE (1) MODE	
					dB max	dB typ	dB var (4)					
F 5206 (2)	(5)	1060	1	60	45	40	4	2.5	20	20	T	
TH 5219 (3)	(5)	1630	7	10	105		2	2	18	25	R	

(1) T : en transmission - *Transmission mode*

(2) Puissance 500 W crête (10 μs - 1 %) - *Power : 500 W peak (10 μs - 1 %)*

(3) Puissance 1 KW crête (10 μs - 1 %) - *Power : 1 KW peak (10 μs - 1 %)*

(4) Ondulation dans la bande de fréquence - *Ripple in frequency range*

(5) Nous consulter - *Please refer to THOMSON-CSF*

lignes à grand retard

very long delay lines

CARACTÉRISTIQUES A $T = 25^{\circ}\text{C}$							
SPECIFICATIONS AT							
TYPE TYPE	BOITIER CASE	BANDE DE FRÉQUENCE FREQUENCY RANGE MHz	RETARD DELAY μs	PERTES INSERTION LOSS dB typ	R.O.S. V.S.W.R. max	MODE (1) MODE	
F 5414	G 3	1030 - 1090	120	75	2.5	R	
F 5029	G 3	1200 - 1400	20	30	2.5	R	
F 5031	G 3	1200 - 1400	50	50	2.5	R	
F 5026	G 3	1200 - 1400	80	70	2.5	R	
F 5421	G 1	2100 - 2450	15	45	2.5	R	
F 5432	G 1	2300 - 2500	30	60	2.5	R	
F 5041	G 1	2300 - 2500	33	80	2.5	R	
F 5415	G 1	2350 - 2550	33	60	2.5	R	
F 5410	G 1	2450 - 2550	43	80	2.5	R	
F 5411 A	G 1	3200 - 3400	20	70	2.5	R	

(1) R : en réflexion - *Reflective mode* T : en transmission - *Transmission mode*

lignes à retard à échos multiples

multiecho delay lines

CARACTÉRISTIQUES A $T = 25^{\circ}\text{C}$								
SPECIFICATIONS AT								
TYPE TYPE	BOITIER CASE	BANDE DE FRÉQUENCE FREQUENCY RANGE MHz	NOMBRE D'ÉCHOS UTILES/SÉPARÉS DE : μs NUMBER OF USEFUL ECHOS/SEPARATED by : μs	RETARD 1 ^{er} ÉCHO 1 st ECHO DELAY μs	PERTES 1 ^{er} ÉCHO 1 st ECHO LOSS dB typ	PERTES ENTRE ÉCHOS LOSS BETWEEN ECHOES dB typ	R.O.S. V.S.W.R.	MODE (1) MODE
F 5420	G 5	1220 - 1340	4/20	20	35	10	2.5	R
LR 1301	G 5	1200 - 1400	10/1	1	20	0.8	2.5	R

(1) T : en transmission - *Transmission mode* R : en réflexion - *Reflective mode*

(4) : ondulation dans la bande de fréquence - *Ripple in frequency range*

composants à ferrite
ferrite components



composants à ferrite

ferrite components

THOMSON-CSF commercialise depuis plus de 25 années toute la gamme des dispositifs gyromagnétiques hyperfréquence : circulateurs, isolateurs, déphaseurs, filtres YIG... La gamme de ces produits s'étend des longueurs d'ondes métriques (50 MHz) jusqu'aux longueurs d'ondes millimétriques (100 GHz).

- La Division Composants Microonde de THOMSON-CSF a développé en particulier des dispositifs à très large bande tels que isolateurs multioctaves OSEL, circulateurs 225-400 MHz et des dispositifs à très faibles pertes pour amplificateurs paramétriques.

- Dans le domaine des puissances élevées, les duplexeurs supportent des puissances moyennes atteignant 50 kW et des puissances crêtes de 10 MW.

La Division Composants Microonde a participé également à la réalisation des dispositifs gyromagnétiques équipant les satellites ou les stations terriennes de la plupart des programmes spatiaux (OTS, Symphonie, Télécom 1...)

Les pages suivantes contiennent un large éventail des dispositifs standard fabriqués par la Division Composants Microonde. Pour toutes applications particulières nous consulter.

For more than 25 years, THOMSON-CSF has distributed a complete range of microwave gyromagnetic devices : circulators, isolators, phase shifters, YIG filters...

The range of these products covers metric wavelengths (50 MHz) to millimeter wavelengths (100 GHz).

- *In particular, THOMSON-CSF Microwave Component Division has developed very wide bandwidth devices such as OSEL multi-octave isolators, 225-400 MHz circulators and very low loss devices for parametric amplifiers.*

- *The duplexers can withstand mean power ratings of up to 50 kW and peak powers of 10 MW in the high power range.*

The Microwave Component Division has also participated in the development of the gyromagnetic devices mounted on satellites or the ground stations of most spatial programs (OTS, Symphonie, Telecom 1, etc.).

A wide range of standard devices manufactured by the Microwave Component Division is listed in the following pages. For specific applications, please refer to THOMSON-CSF.

dispositifs coaxiaux coaxial devices



TMU 09



TBK 401



TBC 281

circulateurs coaxiaux, 3 voies 3 port coaxial circulators

TYPE TYPE	BANDE DE FRÉQUENCE FREQUENCY RANGE	BANDE PASSANTE BANDWIDTH	CARACTÉRISTIQUES A SPECIFICATIONS AT			CARACTÉRISTIQUES DANS LA GAMME DE TEMPÉRATURES SPECIFICATIONS IN TEMPERATURE RANGE			GAMME DE TEMPÉ- RATURES TEMPE- RATURE RANGE	PUIS- SANCE MOYENNE MEAN POWER	PUIS- SANCE CRÊTE PEAK POWER	CONNECTEUR CONNECTOR	DIMENSIONS DIMENSIONS	POIDS WEIGHT
			T = 25°C DÉCOUPLAGE ISOLATION dB	PERTES INSERTION LOSS dB	R.O.S. V.S.W.R.	DÉCOUPLAGE ISOLATION dB	PERTES INSERTION LOSS dB	R.O.S. V.S.W.R.						
	GHz	MHz							W	KW		mm	kg	
F 30600	0.06 - 0.1	2.5	20	0.8	1.25	18	1	1.3	-10 + 60	30		SMA/N	30 x 65 x 65	0.36
F 30600 A	0.065 - 0.080	3	23	0.6	1.25	18	1	1.3	-20 + 55	20		SMA	70 x 70 x 40	0.65
F 30588	0.1 - 0.25	6	20	0.6	1.25	18	0.8	1.3	-10 + 60	30		SMA/N	25 x 52 x 52	0.250
YBU 63	0.1 - 0.15	3.5 %	20	1	1.3	20	1	1.3	-10 + 60	20		BNC	∅ 70 x 33.5	
TBU 62	0.136	1.5 %	10	1	1.3	10	1	1.3	-20 + 70	20		BNC	41 x 53 x 22	
YBU 64	0.15 - 0.3	3.5 %	20	1	1.3	20	1	1.3	-10 + 60	20		BNC	∅ 70 x 33.5	
YBA 45	0.17 - 0.20	T	21	0.3	1.25	20	0.35	1.25	0 + 50	100		N	69.8 x ∅ 86	1.8
YBA 46	0.20 - 0.23	T	21	0.3	1.25	20	0.35	1.25	0 + 50	100		N	69.8 x ∅ 86	1.8
YBU 64-1	0.225 - 0.4	3.5 %	20	0.8	1.25	20	0.8	1.25	-10 + 60	20		BNC	∅ 62 x 37	
F 30629	0.225 - 0.400	T	20	0.7	1.25	17	1.2	1.35	-40 + 70	60	0.250	SMA	65 x 52 x 29	0.37
R 2988 A	0.25 - 0.35	25	18	0.8	1.35	17	1	1.4	-10 + 60	25		SMA	25 x 45 x 42	0.115
AR 2922	0.35 - 0.45	35	18	0.8	1.35	17	1	1.4	-10 + 60	25		SMA	25 x 45 x 42	0.115
TMU 06	0.4 - 0.6	T	16	0.8	1.5	15	1	1.6	-40 + 80	40	1	SMA	102 x 84 x 42	0.91
YBU 66	0.4 - 0.6	3.5 %	20	1	1.25	20	1	1.3	-10 + 60	20		BNC	∅ 62 x 37	
TBU 45	0.406 - 0.430	T	20	0.6	1.20	18	0.8	1.25	-20 + 80			SMA	30 x 40 x 13.7	0.075
F 30576	0.406 - 0.470	T	20	0.5	1.25	18	0.7	1.35	-20 + 70	100	5	N	∅ 80 x 58	1.3
YBU 16	0.43 - 0.47	T	22	0.3	1.20	20	0.5	1.20	0 + 50	100		N	56 x ∅ 79.5	0.75
YBU 06	0.43 - 0.47	T	22	0.4	1.20	20	0.5	1.25	0 + 50	350	2	N	97 x 113 x 42	2
TBU 46	0.44 - 0.47	T	20	0.6	1.20	18	0.8	1.25	-20 + 80			SMA	30 x 40 x 13.7	0.075
AR 2923	0.45 - 0.60	45	18	0.8	1.35	17	1	1.4		25		N	25 x 30 x 30	0.085
YBU 17	0.47 - 0.57	T	22	0.3	1.20	22	0.4	1.20	0 + 50	100		N	56 x ∅ 79.5	0.75
YBU 07	0.47 - 0.57	T	22	0.4	1.20	20	0.5	1.25	0 + 50	350	2	N	97 x 113 x 42	2
F 30577	0.47 - 0.60	T	20	0.5	1.25	18	0.7	1.35	-20 + 70	100	5	N	∅ 80 x 58	1.3
TBU 47	0.54 - 0.64	T	15	0.6	1.5	15	1	1.5	-10 + 60			SMA	30 x 30.5 x 19.5	0.065
YBU 18	0.57 - 0.7	T	22	0.3	1.20	22	0.4	1.20	0 + 50	100		N	56 x ∅ 79.5	0.75
YBU 08	0.57 - 0.7	T	22	0.4	1.20	20	0.5	1.25	0 + 50	350	2	N	97 x 113 x 42	2
F 30578	0.59 - 0.72	T	20	0.5	1.25	18	0.7	1.35	-20 + 70	100	5	N	∅ 80 x 58	1.3
TMU 09	0.600 - 0.960	T	14	1	1.5	13	1.2	1.6	-40 + 80	40	1	SMA	80 x 68 x 38.5	0.7
TBU 481	0.635 - 0.660	T	20	0.5	1.25	18	0.6	1.30	-20 + 70			SMA	30 x 30.5 x 13.9	0.05
TBU 48	0.640 - 0.710	T	20	0.6	1.30	18	0.6	1.35	-10 + 70			SMA	30 x 30.5 x 13.9	0.05
F 30543	0.70 - 0.80	75	25	0.4	1.15	20	0.5	1.25	-30 + 70	10	1	SMA	38 x 35 x 19.3	0.16
YBU 19	0.70 - 0.86	T	22	0.3	1.20	22	0.4	1.20	0 + 50	100	1	N	56 x ∅ 79.5	0.75
YBU 09	0.70 - 0.86	T	22	0.4	1.20	20	0.5	1.25	0 + 50	350	2	N	97 x 113 x 42	2
F 30579	0.71 - 0.86	T	20	0.5	1.25	18	0.7	1.35	-20 + 70	100	5	N	∅ 80 x 58	1.3
F 30558	0.80 - 0.95	T	23	0.5	1.20	20	0.6	1.25	-30 + 70	10	1	SMA	30 x 30.5 x 19	0.10
TBL 30	0.80 - 1.20	10 %	20	0.4	1.25	18	0.5	1.30	-30 + 70			SMA	37 x 35.5 x 19	0.15
YBU 11	0.815 - 0.960	T	25	0.5	1.15	20	0.5	1.20	0 + 60	150		N	53 x ∅ 94.5	1.2
F 30522	0.85 - 1.1	T	20	0.5	1.25	18	0.7	1.35	-20 + 70	100	5	N	∅ 80 x 58	1.3
TBL 20	0.85 - 1.20	3 %	20	0.5	1.25	18	0.6	1.30	0 + 70			SMA	28.6 x 29 x 19.7	0.08
TBU 31	0.86 - 0.96	T	22	0.4	1.20	20	0.5	1.25	0 + 70			SMA	53.4 x 54 x 28	0.3
YBU 68	0.9 - 1.2	3.5 %					20	0.4	-10 + 60			BNC	∅ 62 x 22	
TBU 30	0.93 - 1.04	T	22	0.4	1.20	18	0.5	1.30	-40 + 70			SMA	53.4 x 54 x 28	0.3
TBL 03	0.93 - 1.04	T	22	0.4	1.20	18	0.5	1.30	-40 + 70	50	1.5	N	53.4 x 54 x 28	0.3
F 30590	0.960 - 1.215	T	20	0.4	1.25	18	0.5	1.30	-40 + 80	100	2	SMA	53 x 48 x 25.5	0.27
TBL 53	0.960 - 1.215	T	20	0.5	1.25	18	0.5	1.35	-10 + 70			SMA	53.4 x 54 x 28	0.3
F 30581	1 - 1.1	T	25	0.4	1.15	20	0.5	1.25	-40 + 70	25	2	SMA	30 x 30.5 x 19	0.10
AR 2972	1 - 1.5	200	25	0.4	1.15	20	0.5	1.25	-40 + 85	10	1	SMA	40 x 40 x 25	0.18
TBL 04	1 - 1.1	3 %	23	0.3	1.20	20	0.4	1.25	0 + 60	50	1.5	N	53.4 x 54 x 28	0.3
TBL 21	1.2 - 1.4	3 %	20	0.4	1.25	18	0.5	1.30	0 + 70			SMA	28.6 x 29 x 24.7	0.1
TBL 10	1.2 - 1.4	T	20	0.2	1.25	18	0.4	1.30	0 + 60	50		N	70 x 70 x 28	0.5
TBL 52	1.2 - 1.4	T	20	0.4	1.25	18	0.4	1.30	0 + 60			SMA	53.4 x 54 x 28	0.3
AR 2925	1.2 - 1.8	T	20	0.5	1.15	20	0.6	1.25	-10 + 60	1		SMA	29 x 26 x 22	0.07
TBL 11	1.21 - 1.32	T	23	0.3	1.20	20	0.4	1.30	-30 + 55	50	1.5	N	53.4 x 54 x 28	0.3
TBL 12	1.25 - 1.35	T	23	0.3	1.20	20	0.4	1.30	-30 + 55	50	1.5	N	53.4 x 54 x 28	0.3
TBL 51	1.3 - 1.65	T	21	0.4	1.20	20	0.5	1.20	-20 + 55			SMA	53.4 x 54 x 28	0.3
F 30556	1.35 - 1.70	T	18	0.5	1.3	17	0.7	1.35	-40 + 80	20	1	SMA	30 x 30 x 19	0.1
TBL 511	1.35 - 1.70	T	20	0.5	1.25	18	0.55	1.30	-25 + 55			SMA	53.4 x 54 x 28	0.3
TBL 41	1.35 - 2.1	T	18	0.4	1.30	14	0.4	1.5	-40 + 85	25		N	114.4 x 113.3 x 28.4	1.2
AR 2954	1.4 - 1.8	T	20	0.3	1.25	17	0.5	1.35	-10 + 50	25	0.1	SMA	56 x 53 x 18	0.16
F 30534	1.6 - 1.9	T	20	0.4	1.25	18	0.5	1.30	-40 + 70	10	1	SMA	30 x 30 x 19	0.10
TBL 54	1.65 - 1.75	T	20	0.3	1.25	20	0.3	1.25	-20 + 70			SMA	53.4 x 54 x 28	0.3

T: total T: full band

dispositifs coaxiaux coaxial devices

circulateurs coaxiaux, 3 voies 3 port coaxial circulators

TYPE TYPE	BANDE DE FRÉQUENCE FREQUENCY RANGE	BANDE PASSANTE BANDWIDTH	CARACTÉRISTIQUES A SPECIFICATIONS AT			CARACTÉRISTIQUES DANS LA GAMME DE TEMPÉRATURES SPECIFICATIONS IN TEMPERATURE RANGE			GAMME DE TEMPE- RATURES TEMPER- ATURE RANGE	PUISS- SANCE MOYENNE MEAN POWER	PUISS- SANCE CRÊTE PEAK POWER	CONNECTEUR CONNECTOR	DIMENSIONS DIMENSIONS	POIDS WEIGHT
			DÉCOUPLAGE ISOLATION	Pertes INSERTION LOSS	R.O.S. V.S.W.R.	DÉCOUPLAGE ISOLATION	Pertes INSERTION LOSS	R.O.S. V.S.W.R.						
	GHz	MHz	dB	dB		dB	dB		W	kW		mm	kg	
TBL 14	1.68 - 1.78	T	23	0.3	1.25	20	0.5	1.25	- 10 + 60	50		N	53.4 x 54 x 28	0.3
F 30567	1.7 - 2.1	T	25	0.3	1.12	18	0.5	1.30	- 30 + 80	10	0.1	SMA	49 x 50 x 15	0.14
TBS 221	1.7 - 2.1	T	22	0.3	1.20	20	0.3	1.25	- 25 + 55			SMA	63.5 x 63.6 x 25.6	0.5
TBS 22	1.7 - 2.3	T	22	0.3	1.20	20	0.4	1.25	- 30 + 70	20		N	63.5 x 63.6 x 28.6	0.5
YBS 20	1.7 - 2.7	T	20	0.4	1.25	18	0.5	1.30	0 + 55	20		N	∅ 68 x 35	0.7
TBS 60	1.8 - 2.1	T	20	0.4	1.20	17	0.5	1.35	- 20 + 60			SMA	27.6 x 26.6 x 13.7	0.05
TBS 255	1.8 - 2.1	T	25	0.3	1.15	20	0.3	1.25	- 20 + 60			SMA	44.3 x 44.5 x 15.2	0.05
F 30568	2 - 2.3	T	25	0.4	1.12	18	0.5	1.30	- 40 + 80	10	0.1	SMA	45 x 44 x 15	0.09
TBS 41	2 - 3	T	20	0.3	1.25	18	0.5	1.30	0 + 60	20		N	56.9 x 61.3 x 27.5	0.40
F 30531	2 - 2.7	T	20	0.4	1.25	18	0.5	1.30	- 10 + 60	10	0.1	SMA	45 x 44 x 15	0.09
TBS 51	2.05 - 2.85	T	25	0.3	1.15	18	0.5	1.30	- 40 + 70			SMA	56.3 x 57.6 x 22.3	0.25
TBS 25	2.1 - 2.3	T	25	0.3	1.15	20	0.3	1.20	- 20 + 60			SMA	44.3 x 44.5 x 15.2	0.15
TBS 511	2.1 - 2.7	T	22	0.3	1.20	20	0.3	1.25	- 25 + 55			SMA	63.5 x 63.6 x 25.6	0.20
TBS 61	2.15 - 2.5	T	20	0.4	1.20	17	0.5	1.35	- 20 + 60			SMA	27.6 x 26.6 x 13.7	0.20
F 30569	2.3 - 2.7	T	25	0.4	1.12	17	0.6	1.40	- 40 + 80	10	0.1	SMA	45 x 44 x 15	0.09
TBS 52	2.3 - 4.3	T	16	0.5	1.40	14	0.7	1.50	0 + 70			SMA	56.3 x 57.6 x 22.3	0.25
TMS 15	2.35 - 2.55	T	25	0.35	1.15	20	0.5	1.20	0 + 50	220	7.5	N	56.9 x 61.3 x 31.6	0.4
TBS 26	2.4 - 2.6	T	20	0.3	1.25	16	0.5	1.40	- 20 + 60			SMA	30.7 x 32.4 x 17.2	0.07
TMS 13	2.4 - 2.6	T	25	0.4	1.15	20	0.5	1.25	0 + 60	150	3	N	56.9 x 61.3 x 27.5	0.4
YBS 13	2.5 - 3.5	T	22	0.3	1.20	20	0.3	1.25	0 + 60	20		N	∅ 76.2 x 35.2	0.65
R 2916 B	2.6 - 3.4	T	23	0.3	1.15	20	0.35	1.25	- 10 + 50	10	0.1	SMA	42 x 40 x 16	0.08
TBS 13	2.9 - 3.1	T	20	0.3	1.25	16	0.5	1.40	- 20 + 60			SMA	30.7 x 32.4 x 17.2	0.09
TBS 411	2.9 - 3.2	T	30	0.4	1.15	25	0.5	1.20	0 + 50	20		N	56.9 x 61.3 x 27.5	0.4
TBC 22	3 - 3.5	T	26	0.3	1.10	20	0.5	1.20	- 40 + 70			SMA	43.7 x 44.1 x 19.2	0.15
TBC 21	3.2 - 3.7	T	30	0.3	1.10	20	0.4	1.20	- 55 + 70			SMA	43.7 x 44.1 x 19.2	0.15
TBC 23	3.5 - 4	T	25	0.25	1.15	20	0.3	1.25	- 20 + 70			SMA	32.4 x 32.7 x 15.8	0.055
TBC 281	3.7 - 4.2	T	30	0.2	1.10	25	0.2	1.10	0 + 70			SMA	25.4 x 27.7 x 17.5	0.05
TBC 29	3.7 - 4.2	T	20	0.2	1.25	18	0.3	1.30	- 40 + 70			SMA	24.6 x 22 x 17	0.05
TBC 282	3.7 - 4.2	T	27	0.3	1.10	25	0.3	1.15	+ 15 + 45		20	N	25.4 x 35.1 x 27.4	0.05
R 2943 B	3.7 - 4.2	T	30	0.25	1.10	23	0.3	1.15	- 40 + 85	10	0.1	SMA	29 x 26 x 16	0.06
AR 2988	3.7 - 4.2	T	25	0.25	1.15	20	0.3	1.20	- 20 + 60	10	0.1	SMA	28 x 25 x 18	0.06
TBC 33	3.7 - 3.9	T	23	0.2	1.15	18	0.3	1.30	- 40 + 70			SMA	24.6 x 22 x 17	0.045
R 2943 A	4 - 4.6	T	30	0.25	1.10	23	0.3	1.20	- 40 + 85	10	0.1	SMA	29 x 26 x 16	0.06
TBC 54	4 - 5	T	22	0.3	1.15	20	0.3	1.20	- 30 + 70			SMA	27.3 x 29.7 x 15.8	0.05
F 30536	4 - 5	600	30	0.26	1.10	25	0.3	1.2	- 40 + 80	10	0.1	SMA	29 x 26 x 18	0.05
F 30546	4 - 5	T	23	0.3	1.20	20	0.40	1.25	- 10 + 60	10	0.1	SMA	28 x 25.5 x 16.5	0.05
TBC 32	4.2 - 4.4	T	25	0.3	1.15	23	0.3	1.20	- 20 + 70			SMA	25.4 x 27.7 x 17.5	0.05
TBC 51	4.3 - 6.9	T	20	0.3	1.25	18	0.4	1.30	0 + 70			SMA	25.4 x 27.7 x 17.5	0.05
TBC 541	4.4 - 5	T	30	0.2	1.10	23	0.3	1.15	- 25 + 75			SMA	27.3 x 29.7 x 15.8	0.05
TBC 34	4.6 - 5.2	T	20	0.2	1.25	18	0.3	1.30	- 40 + 70			SMA	18 x 22 x 16.5	0.04
AR 2920 B	5 - 10.5	1500	30	0.3	1.10	23	0.40	1.20	- 30 + 100	5	0.03	SMA	30 x 29 x 20	0.07
R 2989 B	5 - 7.5	1200	30	0.3	1.10	25	0.40	1.20	- 50 + 90	5	0.1	SMA	22 x 20 x 13	0.070
TBC 35	5.3 - 5.9	T	20	0.2	1.25	18	0.3	1.30	- 40 + 70			SMA	18 x 22 x 16.5	0.04
TBC 60	5.4 - 5.9	T	20	0.3	1.25	18	0.3	1.30	- 40 + 70			SMA	12.7 x 12.7 x 12.7	0.04
TBC 41	5.4 - 5.9	T	25	0.4	1.20	20	0.5	1.25	- 40 + 70	20		N	27.5 x 35.1 x 27.6	0.15
R 2989 A	5.9 - 7.5	T	25	0.3	1.15	20	0.40	1.20	- 10 + 60	10	0.1	SMA	22 x 20 x 13	0.070
TBC 621	5.9 - 6.4	T	23	0.25	1.15	23	0.25	1.15	0 + 60			SMA	16 x 22.7 x 18	0.03
TBC 612	5.9 - 6.4	T	20	0.25	1.25	18	0.3	1.30	- 40 + 70			SMA	16 x 22.7 x 18	0.03
TBC 625	5.9 - 6.4	T	25	0.12	1.10	23	0.12	1.15	0 + 50			SMA	16 x 22.7 x 18	0.03
TBC 623	5.9 - 6.4	T	20	0.3	1.25	18	0.3	1.30	- 40 + 70			SMA	12.9 x 17.2 x 12.7	0.03
TBC 62	5.9 - 6.5	T	20	0.3	1.25	18	0.3	1.30	- 40 + 70			SMA	12.7 x 12.7 x 12.7	0.015
TBC 631	6.4 - 7.1	T	23	0.25	1.15	20	0.25	1.20	0 + 60			SMA	16 x 22.7 x 18	0.03
TBC 643	6.4 - 7.1	T	20	0.3	1.30	17	0.3	1.40	- 40 + 70			SMA	12.9 x 17.2 x 12.7	0.03
TBC 64	6.4 - 7.1	T	19	0.3	1.25	18	0.3	1.30	- 40 + 70			SMA	12.7 x 12.7 x 12.7	0.015
TBC 635	6.4 - 7.1	T	25	0.12	1.10	23	0.12	1.15	0 + 50			SMA	16 x 22.7 x 18	0.030
TBC 651	7.1 - 7.8	T	28	0.2	1.08	25	0.3	1.15	0 + 55			SMA	16 x 22.7 x 18	0.030
TBC 661	7.1 - 7.8	T	23	0.4	1.15	20	0.5	1.20	- 30 + 70			SMA	16 x 22.7 x 18	0.030
TBC 663	7.1 - 7.8	T	20	0.3	1.25	18	0.3	1.30	- 40 + 70			SMA	12.9 x 17.2 x 12.7	0.030
TBC 66	7.1 - 7.8	T	19	0.3	1.30	17	0.3	1.40	- 40 + 70			SMA	12.7 x 12.7 x 12.7	0.015
TBX 313	7.55 - 8.35	T	20	0.3	1.25	18	0.3	1.30	- 30 + 70			SMA	12.7 x 12.7 x 12.7	0.015
TBX 312	7.6 - 8.4	T	20	0.3	1.25	18	0.3	1.30	- 30 + 70			SMA	12.7 x 12.7 x 12.7	0.015
TBX 314	7.65 - 8.45	T	20	0.3	1.25	18	0.35	1.30	- 30 + 70			SMA	12.9 x 17.2 x 12.7	0.030



YBU 17



F 30100 A



F 30629



F 30644

circulateurs coaxiaux, 3 voies 3 port coaxial circulators

TYPE TYPE	BANDE DE FRÉQUENCE FREQUENCY RANGE	BANDE PASSANTE BANDWIDTH	CARACTERISTIQUES A SPECIFICATIONS AT			CARACTERISTIQUES DANS LA GAMME DE TEMPÉRATURES SPECIFICATIONS IN TEMPERATURE RANGE			GAMME DE TEMPÉ- RATURES TEMPÉ- RATURE RANGE	PUIS- SANCE MOYENNE MEAN POWER	PUIS- SANCE CRÊTE PEAK POWER	CONNECTEUR CONNECTOR	DIMENSIONS DIMENSIONS	POIDS WEIGHT
			T = 25°C	DÉCOUPLAGE ISOLATION	Pertes INSERTION LOSS	R.O.S. V.S.W.R.	DÉCOUPLAGE ISOLATION	Pertes INSERTION LOSS						
	GHz	MHz	dB	dB		dB	dB		W	kW		mm	kg	
TBX 302	7.8 - 8.1	T	22	0.3	1.20	20	0.3	1.30	-40 + 100			SMA	12.7 x 12.7 x 12.7	0.015
TBX 30	7.8 - 8.7	T	20	0.3	1.25	18	0.3	1.30	-40 + 70			SMA	12.7 x 12.7 x 12.7	0.015
TBX 303	7.8 - 8.7	T	20	0.3	1.25	18	0.3	1.30	-40 + 70			SMA	12.9 x 17.2 x 12.7	0.030
F 30595	8 - 13	1000	20	0.3	1.20	20	0.35	1.20	-30 + 70	10	0.05	SMA	12.7 x 12.7 x 12.7	0.018
F 30603	8 - 11	2000	23	0.5	1.20	20	0.5	1.25	-40 + 100	10	0.1	SMA	16.5 x 22.5 x 18.5	0.040
TBX 32	8.7 - 9.6	T	20	0.3	1.25	18	0.3	1.30	-40 + 70			SMA	12.7 x 12.7 x 12.7	0.015
TBX 33	8.9 - 9.9	T	20	0.3	1.25	18	0.3	1.30	-40 + 70			SMA	12.7 x 12.7 x 12.7	0.015
TBX 325	9.2 - 9.5	T	22	0.3	1.20	20	0.3	1.30	-40 + 80			SMA	12.7 x 12.7 x 12.7	0.015
TBX 34	9.6 - 10.6	T	20	0.3	1.25	18	0.3	1.30	-40 + 70			SMA	12.7 x 12.7 x 12.7	0.015
TBX 343	9.6 - 10.6	T	20	0.3	1.25	18	0.3	1.30	-40 + 70			SMA	12.9 x 17.2 x 12.7	0.030
F 30604	10 - 12	T	25	0.4	1.25	20	0.4	1.25	-40 + 100	10	0.1	SMA	16.5 x 22.5 x 18.5	0.040
TBX 353	10.125 - 10.875	T	20	0.3	1.20	20	0.4	1.25	+ 10 + 50			SMA	12.9 x 17.2 x 12.7	0.030
F 30605	10.2 - 12.4	T	25	0.3	1.15	20	0.4	1.25	-40 + 100	10	0.1	SMA	16.5 x 22.5 x 18.5	0.040
TBX 48	10.5 - 12.5	T	18	0.4	1.35	16	0.5	1.40	-40 + 90			SMA	18 x 22 x 16.5	0.035
TBX 36	10.6 - 11.7	T	20	0.3	1.25	18	0.30	1.30	-40 + 70			SMA	12.7 x 12.7 x 12.7	0.015
TBX 363	10.6 - 11.7	T	20	0.3	1.20	18	0.3	1.30	-40 + 70			SMA	12.9 x 17.2 x 12.7	0.030
TBX 481	10.7 - 11.7	T	25	0.3	1.15	25	0.3	1.15	0 + 60			SMA	18 x 22 x 16.5	0.035
TBX 38	11.3 - 12.4	T	20	0.3	1.25	18	0.3	1.30	-40 + 70			SMA	12.7 x 12.7 x 12.7	0.015
TBX 383	11.5 - 12.5	T	20	0.3	1.15	20	0.4	1.25	-30 + 60			SMA	12.9 x 17.2 x 12.7	0.030
TBK 32	12 - 13.25	T	23	0.5	1.15	20	0.5	1.25	-40 + 70			SMA	12.7 x 12.7 x 12.7	0.015
TBK 34	12.2 - 13.3	T	23	0.5	1.15	20	0.5	1.25	-40 + 70			SMA	12.7 x 12.7 x 12.7	0.015
TBK 323	12.5 - 13.5	T	20	0.3	1.15	20	0.4	1.25	-30 + 60			SMA	12.9 x 17.2 x 12.7	0.03
F 30606	12.5 - 13.5	T	20	0.5	1.25	20	0.5	1.25	-40 + 100	10	0.1	SMA	16.5 x 22.5 x 18.5	0.040
TBK 36	13.1 - 13.7	T	23	0.5	1.15	20	0.5	1.25	-40 + 70			SMA	12.7 x 12.7 x 12.7	0.015
TBK 363	13.175 - 13.675	T	20	0.4	1.20	20	0.5	1.25	+ 10 + 50			SMA	12.9 x 17.2 x 12.7	0.030
TBK 373	13.5 - 14.1	T	20	0.3	1.15	20	0.4	1.25	-30 + 60			SMA	12.9 x 17.2 x 12.7	0.030
TBK 353	14 - 14.5	T	20	0.4	1.20	20	0.5	1.25	+ 15 + 45			SMA	12.9 x 17.2 x 12.7	0.030
TBK 38	14 - 14.5	T	23	0.5	1.15	20	0.5	1.25	-40 + 70			SMA	12.7 x 12.7 x 12.7	0.015
TBK 40 M	15 - 18	T	20	0.5	1.25	18	0.6	1.30	-54 + 70			SMA	12.7 x 12.7 x 12.7	0.015
TBK 401	15.5 - 16	T	28	0.4	1.15	25	0.5	1.30	-40 + 80			SMA	12.7 x 12.7 x 12.7	0.015
TBK 402	15.6 - 16.2	T	23	0.5	1.20	20	0.6	1.30	-40 + 100			SMA	12.7 x 12.7 x 12.7	0.015

circulateurs coaxiaux, 3 voies - large bande 3 port, wideband coaxial circulators

AR 2921	1 - 2	T	20	0.5	1.25	17	0.6	1.4	0 + 50	40	0.2	SMA	∅ 120 x 32	1
AR 2959	1.5 - 3	T	20	0.5	1.25	18	0.6	1.3	0 + 50	10	0.2	SMA	72 x 70 x 26	0.6
TBL 55	1.5 - 3	T	20	0.3	1.3	18	0.4	1.3	0 + 60	20		SMA	76 x 78 x 26	0.6
F 30539	1.7 - 2.5	T	20	0.4	1.25	18	0.5	1.3	-40 + 85	10	0.1	SMA	65 x 61 x 15	0.4
AR 2902	2 - 4	T	20	0.5	1.25	18	0.6	1.3	0 + 50	10	0.2	SMA	∅ 57 x 20	0.3
F 30643	2 - 4	T	18	0.5	1.3	17	0.6	1.4	-30 + 80	10	0.03	SMA	44.4 x 44.4 x 20	0.14
TBS 40	2 - 4	T	18	0.4	1.3	14	0.7	1.5	-20 + 80	20		SMA	57 x 61 x 27	0.4
TBS 50	2 - 4	T	18	0.4	1.3	14	0.7	1.5	-20 + 80	20		SMA	56 x 57 x 22	0.25
TBC 20	3 - 6	T	18	0.4	1.3	14	0.7	1.5	-20 + 80	20		SMA	44 x 44 x 18	0.15
F 30651	3.7 - 6.4	T	20	0.5	1.25	17	0.6	1.4	-30 + 80	10	0.03	SMA	32 x 32 x 20	0.08
TBC 52	3.7 - 7.4	T	18	0.4	1.3	15	0.5	1.4	+ 15 + 45	20		SMA	25.4 x 27 x 17	0.05
F 30644	4 - 8	T	18	0.5	1.3	17	0.6	1.4	-30 + 80	10	0.03	SMA	28.6 x 27 x 19	0.09
TBC 50	4 - 8	T	18	0.4	1.3	14	0.7	1.5	-20 + 80	20		SMA	25.4 x 27 x 17	0.05
F 30617	5 - 10.5	T	18	0.5	1.3	15	0.9	1.5	-30 + 100	10	0.03	SMA	39 x 30 x 20	0.08
F 30647	6 - 13.5	T	14	0.6	1.5	14	1	1.5	-50 + 100	10	0.03	SMA	16 x 20.5 x 20.5	0.05
F 30601	7 - 11	T	20	0.5	1.25	18	0.6	1.3	-40 + 100	10	0.1	SMA	18 x 22 x 18	0.04
F 30602	7 - 12.4	T	20	0.5	1.3	18	0.6	1.3	-40 + 100	10	0.1	SMA	18 x 22 x 18	0.04
MH 713	7 - 11	T	20	0.5	1.4				-30 + 70	10		SMA	17.4 x 19 x 15	0.05
F 30647	7.5 - 15	T	14	0.6	1.5	14	0.7	1.5	-50 + 100	10	0.03	SMA	16 x 20.5 x 20.5	0.05
MH 712	8.2 - 12.4	T	20	0.5	1.4				-30 + 70	10		SMA	17.4 x 19 x 15	0.05
F 30585	8.2 - 12.4	T	20	0.5	1.25	20	0.5	1.3	-40 + 100	10	0.1	SMA	18 x 22 x 18	0.04
F 30586	8 - 18	T	15	0.5	1.4	15	0.8	1.5	-40 + 100	10	0.1	SMA	18 x 22 x 18	0.04

T : total T_i : full band

dispositifs coaxiaux coaxial devices



HBC 632

HBL 11

HBC 286

circulateurs coaxiaux, 4 voies 4 port coaxial circulators

TYPE TYPE	BANDE DE FRÉQUENCE FREQUENCY RANGE GHz	BANDE PASSANTE BAND- WIDTH MHz	CARACTÉRISTIQUES A SPECIFICATIONS AT T = 25 °C					CARACTÉRISTIQUES DANS LA GAMME DE TEMPÉRATURES SPECIFICATIONS IN TEMPERATURE RANGE					GAMME DE TEMPÉ- RATURES TEMPÉ- RATURE RANGE °C	PUI- SANCE MOYENNE MEAN POWER W	PUI- SANCE CRÊTE PEAK POWER kW	CONNEC- TEUR CONNEC- TOR	DIMENSIONS DIMENSIONS mm	POIDS WEIGHT kg
			DÉCOUPLAGE ISOLATION dB		PERTES INSERTION LOSS dB		R.O.S V.S.W.R	DÉCOUPLAGE ISOLATION dB		PERTES INSERTION LOSS dB		R.O.S V.S.W.R						
			2-1 4-3	3-2 1-4	1-2 3-4	2-3 4-1		2-1 4-3	3-2 1-4	1-2 3-4	2-3 4-1							
HBU 110	0.79 - 0.89	T	23	45	0.4	0.8	1.15	20	40	0.5	0.8	1.25	0 + 50			SMA	80 x 35 x 19	0.29
HBU 111	0.89 - 0.96	T	23	45	0.4	0.8	1.15	20	40	0.5	0.8	1.25	0 + 50			SMA	80 x 35 x 19	0.29
AR 2974A	0.9 - 1.2	100	20	40	0.6	1	1.25	20	40	0.6	1.1	1.25	-40 + 70	10	2	SMA	25 x 40 x 85	0.35
R 2981	0.96 - 1.215	T	20	40	0.35	0.7	1.25	20	40	0.35	0.7	1.25	-30 + 70	100	10	SMA	34 x 110 x 190	1.9
HBL 04	1 - 1.1	T	21	43	0.3	0.6	1.20	20	40	0.4	0.7	1.25	0 + 60	50	1.5	N	53.4 x 106.5 x 28	0.6
HBL 11	1.2 - 1.3	T	21	45	0.3	0.6	1.15	20	40	0.3	0.6	1.25	-30 + 55	50	1.5	N	53.4 x 106.5 x 28	0.6
HBL 12	1.25 - 1.35	T	25	50	0.4	0.8	1.25	20	40	0.5	1	1.25	-50 + 85	50		N	53.4 x 106.5 x 28	0.6
HBL 10	1.2 - 1.4	T	21	45	0.2	0.4	1.20	18	35	0.4	0.8	1.30	0 + 60	50		N	70 x 132 x 28	1
F 30500	1.2 - 1.8	100	20	40	0.3	0.5	1.20	20	40	0.35	0.65	1.20	0 + 50	50	0.5	SMA	26 x 61 x 108	0.4
AR 2928	1.425 - 1.575	T	20	40	0.3	0.6	1.20	25	40	0.35	0.7	1.20	0 + 50	80	0.5	SMA	30 x 65 x 110	0.7
HBL 54	1.65 - 1.75	T	21	43	0.3	0.6	1.20	20	40	0.3	0.6	1.25	-20 + 70	50	0.2	SMA	53.4 x 106.5 x 28	0.6
HBS 601	1.7 - 1.9	T	23	50	0.4	0.6	1.15	20	40	0.5	0.8	1.20	0 + 50			SMA	55.5 x 25.6 x 13.5	0.08
HBS 602	1.9 - 2.1	T	23	50	0.4	0.6	1.15	20	40	0.5	0.8	1.20	0 + 50			SMA	55.5 x 25.6 x 13.5	0.08
HBS 603	2.1 - 2.3	T	23	50	0.4	0.6	1.15	20	40	0.5	0.8	1.20	0 + 50			SMA	55.5 x 25.6 x 13.5	0.08
HBS 604	2.3 - 2.5	T	23	50	0.4	0.6	1.15	20	40	0.5	0.8	1.20	0 + 50			SMA	55.5 x 25.6 x 13.5	0.08
HMS 14	2.4 - 2.6	T	24	45	0.3	0.6	1.15	20	40	0.3	0.6	1.25	0 + 60	150	3	N	57 x 109.2 x 28.2	0.6
HBS 30	2.5 - 3.5	T	21	42	0.3	0.5	1.20	20	40	0.3	0.6	1.25	0 + 60	10		N	57 x 109.2 x 28.2	0.6
R 2987	2.7 - 3.3	T	20	40	0.3	0.5	1.25	20	40	0.35	0.6	1.25	-20 + 70	20	0.5	SMA	24 x 85 x 125	0.6
F 30548	3.7 - 4.2	T	25	40	0.3	0.5	1.15	20	40	0.4	0.8	1.20	0 + 50	20	0.5	SMA	16 x 29 x 70	0.15
AR 2915D	3.7 - 5.2	T	17	35	0.5	1	1.40	17	35	0.5	1	1.40	-40 + 85	10	0.5	SMA	15.5 x 30 x 57	0.09
HBC 27	3.7 - 5.2	T	22	40	0.3	0.6	1.20	20	40	0.3	0.6	1.25	0 + 40	5		SMA	28.5 x 52 x 17.5	0.09
HBC 28	3.8 - 4.2	T	25	45	0.3	0.6	1.15	20	40	0.3	0.6	1.25	-20 + 70	5		SMA	27.2 x 57.3 x 15	0.29
AR 2930	4.7 - 5.3	T	25	40	0.3	0.6	1.10	25	40	0.35	0.7	1.10	0 + 50	10	0.5	SMA	16 x 30 x 62	0.14
HBC 34	4.8 - 5.2	T	22	40	0.4	0.8	1.20	20	40	0.4	0.8	1.25	-40 + 90	5	1.5	SMA	17 x 42.9 x 17	0.07
HBC 61	5.3 - 5.6	T	20	40	0.3	0.5	1.20	16	35	0.4	0.6	1.40	-20 + 70	5		SMA	13.7 x 25.4 x 12.7	0.05
HBC 60	5.4 - 5.9	T	20	40	0.3	0.5	1.20	16	35	0.4	0.6	1.40	-20 + 70	5		SMA	13.7 x 25.4 x 12.7	0.05
HBC 602	5.4 - 5.9	T	16	35	0.4	0.6	1.40	16	35	0.4	0.6	1.40	-20 + 70	20		SMA	12.7 x 32.1 x 12.7	0.029
HBC 604	5.4 - 5.9	T	16	35	0.4	0.6	1.40	16	35	0.4	0.6	1.40	-40 + 70	20		SMA	12.7 x 32.1 x 12.7	0.029
AR 2909	5.9 - 7.5	T	25	40	0.35	0.7	1.20	20	40	0.4	0.8	1.20	0 + 50	10	0.1	SMA	20 x 30 x 62	0.14
HBC 631	6.4 - 7.1	T	25	50	0.25	0.4	1.10	23	45	0.25	0.4	1.15	0 + 55			SMA	22 x 41.2 x 12.7	0.07
AR 2916	7 - 11	T	20	40	0.5	0.9	1.25	20	40	0.6	1.1	1.25	-30 + 70	10	0.1	SMA	20 x 30 x 68	0.13
HBC 651	7.1 - 7.9	T	23	45	0.25	0.4	1.15	23	45	0.3	0.5	1.15	0 + 55			SMA	22 x 41.2 x 12.7	0.07
HBX 30	7.6 - 8.4	T						18	35	0.3	0.5	1.30	-40 + 70	5		SMA	13.7 x 25.4 x 12.7	0.02
AR 2916B	8.2 - 12.4	T	20	40	0.5	0.9	1.25	20	40	0.6	1.1	1.25	-30 + 70	10	0.03	SMA	20 x 30 x 68	0.13
HBX 32	8.7 - 9.6	T	22	43	0.3	0.5	1.20	16	35	0.4	0.5	1.45	-40 + 70	5		SMA	13.7 x 25.4 x 12.7	0.02
HBX 33	9.2 - 9.5	T	22	43	0.3	0.5	1.20	20	40	0.3	0.5	1.25	-40 + 70	5	0.5	SMA	13.7 x 25.4 x 12.7	0.02
F 30507	13.7 - 14.7	T	16	40	0.55	1	1.25	20	40	0.6	1.1	1.25	-40 + 70	10	0.1	SMA	13 x 18 x 33	0.1
HBK 401	15.5 - 16	T	23	48	0.4	0.7	1.20	22	45	0.5	0.8	1.30	-40 + 100			SMA	12.7 x 25.4 x 12.7	0.02
HBK 40	15.5 - 16.5	T	22	43	0.3	0.6	1.15	20	40	0.3	0.6	1.20	-40 + 100	3		SMA	12.7 x 25.4 x 12.7	0.02
HBK 41	15.8 - 16.3	T	23	48	0.4	0.7	1.20	20	40	0.5	0.8	1.30	-40 + 100			SMA	12.7 x 25.4 x 12.7	0.02
AR 2960	16 - 18	800	20	40	0.4	0.8	1.20	20	40	0.5	0.9	1.20	-40 + 70	10	0.1	SMA	13 x 20 x 34	0.09

circulateurs coaxiaux, 4 voies à faibles pertes (amplificateurs paramétriques) 4 port, low insertion loss, coaxial circulators (parametric amplifiers)

TYPE TYPE	BANDE DE FRÉQUENCE FREQUENCY RANGE GHz	BANDE PASSANTE BANDWIDTH MHz	CARACTÉRISTIQUES A SPECIFICATIONS AT T = 25 °C					GAMME DE TEMPÉRATURES TEMPERATURE RANGE °C	CONNEC- TEUR CONNECTOR	DIMENSIONS DIMENSIONS mm	POIDS WEIGHT kg
			DÉCOUPLAGE ISOLATION dB		PERTES INSERTION LOSS dB		R.O.S V.S.W.R				
			2-1 4-3	3-2 1-4	1-2 3-4	2-3 4-1					
F 30563	1.67 - 1.75	T	30	45	0.12	0.30	1.10	-10 + 60	SMA	160 x 65 x 27	0.7
F 30570	2.2 - 2.3	T	30	45	0.12	0.25	1.10	-10 + 60	SMA	122 x 52 x 27	0.55
F 32205	2.9 - 3.1	T	30	45	0.12	0.25	1.10	-10 + 60	SMA	105 x 46 x 27	0.45
HBC 288	3.6 - 4.3	T	25	40	0.12	0.25	1.10	-20 ± 5	SMA	31.8 x 60 x 21	0.14
HBC 286	3.7 - 4.2	T	33	50	0.1	0.25	1.05	+20 ± 5	SMA	31.8 x 60 x 21	0.14
HBC 287	3.7 - 4.2	T	33	50	0.1	0.25	1.05	-20 ± 5	SMA	31.8 x 60 x 21	0.14
F 30587	3.7 - 4.2	T	30	45	0.12	0.25	1.10	-10 + 60	SMA	67 x 28 x 16	0.18
F 32206	10 - 10.5	T	28	40	0.25	0.5	1.15	-10 + 60	SMA	44 x 18 x 13	0.06
HBX 485	10.85 - 11.8	T	35	50	0.12	0.25	1.05	+25 ± 5	SMA	17.2 x 42.2 x 19.1	0.1
HBX 486	10.85 - 11.8	T	25	40	0.12	0.25	1.10	+25 ± 5	SMA	17.2 x 42.2 x 19.1	0.1

isolateurs coaxiaux

Les circulateurs figurant dans les pages précédentes peuvent être transformés en isolateurs par remplacement d'une sortie par une charge adaptée.

Les charges adaptées standard sont :

1 W moyen 30 W crête 20 W moyen 500 W crête
3 W moyen 100 W crête 50 W moyen 1 kW crête
10 W moyen 100 W crête

Des charges spéciales peuvent être étudiées et installées sur demande.

La désignation commerciale des isolateurs ainsi réalisés s'obtient à partir de la référence du circulateur suivie du suffixe CHx (x indiquant le numéro de la voie portant la charge). exemple :

TBC 66-CH3 : Isolateur réalisé à partir du circulateur TBC 66 avec charge sur la voie 3.
Cependant, pour les circulateurs référencés F 00000 et AR 00000 le tableau suivant donne la liste des isolateurs correspondants.

coaxial isolators

The circulators mentioned in the previous pages can be transformed into isolators by replacing one output by a matched load.

The standard matched loads are :

1 W mean 30 W peak 20 W mean 500 W peak
3 W mean 100 W peak 50 W mean 1 kW peak
10 W mean 100 W peak

Special loads can be studied and mounted on request.

The catalog reference of isolators made up in this manner is the circulator reference followed by a CHx suffix (x being the number of the port bearing the load), e.g., TBC 66-CH3 : isolator built up using circulator TBC 66 with a load on port 3.

This code system is not used for F 00000 and AR 00000 circulators which are listed in the following table.

**tableau de correspondance (circulateurs - isolateurs)
equivalence table (circulators - isolators)**

FREQUENCE FREQUENCY GHz	CIRCULATEUR CIRCULATOR	ISOLATEUR ISOLATOR	FREQUENCE FREQUENCY GHz	CIRCULATEUR CIRCULATOR	ISOLATEUR ISOLATOR
0.065 - 0.080	F 30600 A	F 30100 A	3.7 - 6.4	F 30651	F 30151
0.55 - 1	R 2947 B	AR 2600 B	3.7 - 4.2	AR 2988	AR 2643
0.7 - 0.8	F 30543	F 30043	3.7 - 4.2	R 2943 B	R 2695 C
0.8 - 0.95	F 30558	F 30058	4 - 8	AR 2903	AR 2622
0.96 - 1.215	F 30590	F 30049	4 - 8	F 30644	F 30144
1 - 1.1	F 30581	F 30081	4 - 4.6	R 2943 A	R 2695 A
1 - 2	AR 2921	AR 2620	4 - 5	F 30536	F 30005
1.2 - 1.4	F 30533	F 30010	4 - 5	F 30546	F 30046
1.2 - 1.7	F 30572 A	F 30072	5 - 10.5	AR 2920	R 2694
1.2 - 1.8	AR 2925	AR 2600	5 - 10.5	AR 2920 B	R 2694 C
1.35 - 1.7	F 30556	F 30056	5 - 10.5	F 30617	F 30117
1.4 - 1.8	AR 2954	AR 2654	5 - 7.5	R 2989 B	AR 2604 C
1.5 - 3	AR 2959	F 30025	5.9 - 7.5	R 2989 A	F 30006
1.6 - 1.9	F 30534	F 30012	6 - 13.5	F 30645	F 30145
1.7 - 2.5	F 30539	F 30039	7 - 11	MH 713	MH 703
1.7 - 2.1	F 30567	F 30067	7.5 - 15	F 30647	F 30147
1.9 - 2.3	F 30530	R 2697 B	8.2 - 12.4	MH 712	MH 702
2 - 2.3	F 30568	F 30068	8.2 - 12.4	F 30585	F 30085
2 - 2.7	F 30531	F 30031	8 - 18	F 30586	F 30086
2.3 - 2.7	F 30569	F 30069	8 - 11	F 30603	F 30103
2 - 4	AR 2902	AR 2621	8 - 13	F 30595	F 30095
2 - 4	F 30643	F 30143	10 - 12	F 30604	F 30104
2.6 - 3.4	R 2916 B	AR 2603	10.2 - 12.4	F 30605	F 30105
3 - 6	AR 2918	AR 2623	12.5 - 13.5	F 30606	F 30106

dispositifs coaxiaux coaxial devices



F 30076 F

isolateurs multioctaves "OSEL"

L'isolateur "OSEL" est une marque déposée de THOMSON-CSF. Ces dispositifs offrent des découplages importants dans des bandes de plusieurs octaves et sont capables de répondre aux spécifications militaires en température, vibrations et chocs. Leurs performances les rendent très adaptés aux applications contre-mesures électroniques.

"OSEL" multioctave bandwidth isolators

"OSEL" is a THOMSON-CSF patented brand name for wideband isolators. These devices are suitable for high level decoupling in several octave bandwidths and are capable of meeting shock, vibration and temperature specifications for military applications. The performances of these devices make them fully satisfactory for electronic countermeasure applications.

isolateurs multioctaves "OSEL" multioctave "OSEL" isolators

TYPE TYPE	BANDE DE FRÉQUENCE FREQUENCY RANGE	BANDE PASSANTE BANDWIDTH	CARACTÉRISTIQUES A SPECIFICATIONS AT			CARACTÉRISTIQUES DANS LA GAMME DE TEMPÉRATURES SPECIFICATIONS IN TEMPERATURE RANGE			GAMME DE TEMPÉRATURES TEMPERATURE RANGE	CONNECTEUR CONNECTOR	DIMENSIONS DIMENSIONS	POIDS WEIGHT
			DÉCOUPLAGE ISOLATION	PERTES INSERTION LOSS	R.O.S. V.S.W.R.	DÉCOUPLAGE ISOLATION	PERTES INSERTION LOSS	R.O.S. V.S.W.R.				
	GHz	MHz	dB typ	dB typ	typ	dB min	dB max	max	°C	mm	kg	
F 30114	2 - 4	T	35	1.2	1.22	30	1.2	1.25	0 + 50	SMA	80 x 52 x 30	0.1
F 30022	2 - 10	T	15	1.5	1.25	13 ⁽¹⁾	2 ⁽¹⁾	1.30 ⁽¹⁾	0 + 50	SMA	80 x 52 x 30	0.1
F 30022A	2.5 - 6	T	20	0.9	1.20	20 ⁽²⁾	1 ⁽²⁾	1.20	0 + 50	SMA	67 x 33 x 30	0.1
F 30088	3 - 18	T	17	2	1.45	15	2.2	1.5	0 + 50	SMA	50 x 35 x 26	0.18
F 30079	3.2 - 11	T	20	0.6	1.25	20	0.7	1.30	0 + 50	SMA	50 x 35 x 26	0.18
F 30074	3.5 - 14	T	20	1	1.30	18	1.4	1.35	- 40 + 85	SMA	67 x 33 x 30	0.25
F 30115	4 - 8	T	30	0.7	1.25	30	0.8	1.25	0 + 50	SMA	50 x 35 x 26	0.18
F 30075	7 - 12.4	T	20	0.8	1.25	20	1	1.25	- 40 + 100	SMA	30 x 24 x 22	0.08
F 30076	7 - 18	T	20	1	1.30	18 ⁽³⁾	1.3	1.35	- 40 + 100	SMA	30 x 24 x 22	0.1
F 30116	8 - 12.4	T	35	0.8	1.25	30	0.9	1.25	- 40 + 100	SMA	30 x 24 x 22	0.08
F 30077	9 - 18.3	T	20	0.9	1.3	18	1.2 ⁽⁴⁾	1.35	- 40 + 100	SMA	22 x 19 x 19	0.05

T : total T : full band

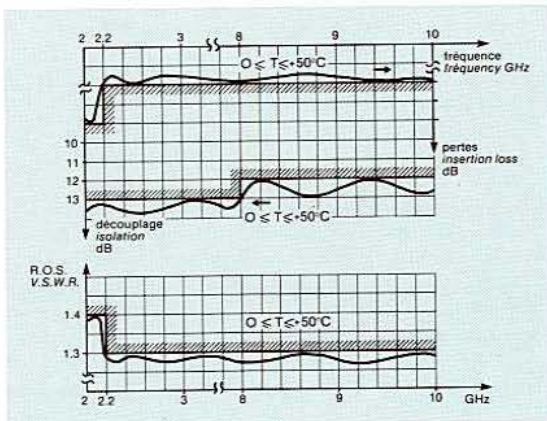

F 30022

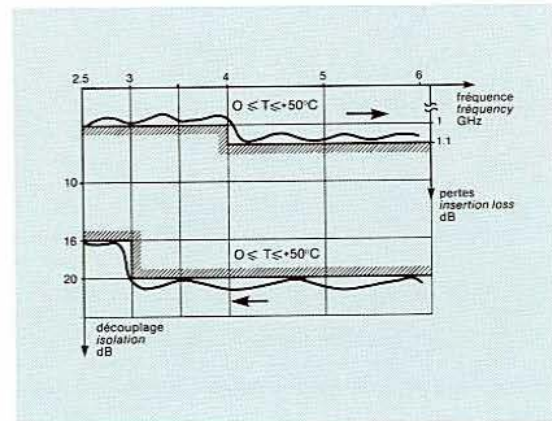

F 30022 A

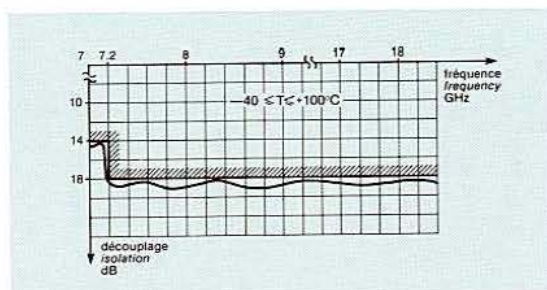

F 30076

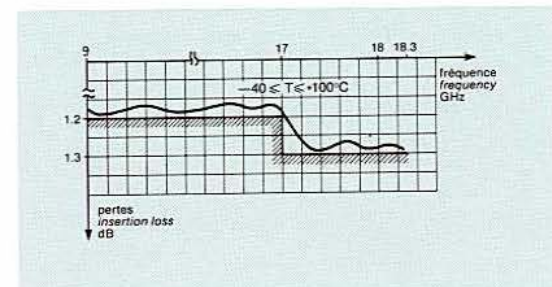

F 30077

dispositifs sur guide waveguide devices



TBC 151



TBX 01



F 10554

circulateurs sur guide, 3 voies 3 port waveguide circulators

TYPE TYPE	BANDE DE FRÉQUENCE RANGE GHz	BANDE PAS- SANTE BAND- WIDTH MHz	CARACTÉRISTIQUES A SPECIFICATIONS AT $T = 25^{\circ}\text{C}$			CARACTÉRISTIQUES DANS LA GAMME DE TEMPÉRATURES SPECIFICATIONS IN TEMPERATURE RANGE			GAMME DE TEMPÉ- RATURES TEMPÉ- RATURE RANGE $^{\circ}\text{C}$	PUI- SANCE MOYENNE MEAN POWER W	PUI- SANCE CRÊTE PEAK POWER kW	GUIDE WAVE- GUIDE	BRIDE* FLANGE	DIMENSIONS DIMENSIONS mm	POIDS WEIGHT kg
			DÉCOU- PLAGE ISOLATION dB	PERTES INSERTION LOSS dB	R.O.S. V.S.W.R.	DÉCOU- PLAGE ISOLATION dB	PERTES INSERTION LOSS dB	R.O.S. V.S.W.R.							
TBS 80	2.9 - 3.2	T	30	0.2	1.10	25	0.2	1.2	0 + 50	300	R 32	UG 584/U	180 x 175 x 135	5.2	
TBC 141	3.4 - 3.8	T	30	0.2	1.07	26	0.2	1.10	0 + 50	150	10	R 40	CMR 229	127 x 121 x 50.8	0.5
TBC 151	3.6 - 4.2	T	30	0.2	1.07	26	0.2	1.10	0 + 50	150	10	R 40	CMR 229	127 x 121 x 59.8	0.5
TBC 152	3.6 - 4.2	T	32	0.1	1.05	28	0.1	1.08	0 + 50	150	10	R 40	CMR 229	127 x 121 x 50.8	0.5
AR 2908 C	3.8 - 4.2	T	31	0.15	1.06	28	0.2	1.08	0 + 50	150	15	R 40	CMR 229	51 x 121 x 127	0.82
R 2967 B	4.2 - 5.4	500	25	0.2	1.15	20	0.3	1.2	0 + 50	20	10	R 48	UG 149A/U	92 x 100 x 115	1.5
TBC 96	4.4 - 5	T	28	0.2	1.10	25	0.2	1.15	- 15 + 45	300	R 48	UER 48	120 x 120 x 74	1.5	
R 2967 A	4.9 - 5.1	T	30	0.15	1.10	30	0.15	1.10	0 + 50	20	10	R 48	UG 149/U	92 x 100 x 115	1.5
AR 2975	5.4 - 5.9	T	20	0.3	1.2	20	0.3	1.2	0 + 50	30	60	R 48	UG 149A/U	130 x 140 x 140	4
TMC 541	5.9 - 6.4	T	32	0.1	1.05	28	0.1	1.08	+ 5 + 50	300	10	R 70	CMR 137	82.6 x 82 x 40	0.23
F 10503	5.9 - 6.4	T	20	0.3	1.2	20	0.3	1.2	- 20 + 60	30	10	R 58	CPR 159	92 x 113 x 120	0.8
R 2974 B	5.85 - 8.2	T	20	0.3	1.25	20	0.3	1.25	+ 10 + 40	10	10	R 70	UG 344 A/U	82.5 x 92.5 x 62	0.8
TBC 781	6.4 - 7.1	T	32	0.1	1.05	28	0.1	1.08	0 + 55	25	10	R 70	CMR 137	82.6 x 82 x 40	0.23
TBC 88	7.12 - 7.42	T	32	0.2	1.08	22	0.2	1.15	0 + 60	25	5	F 70	UGF 70	82.6 x 80 x 29	0.45
F 10502	7.1 - 8.2	T	30	0.15	1.08	28	0.3	1.08	0 + 60	20	10	R 84	UG 51/U	67 x 67 x 50	0.5
TBC 751	7.1 - 7.7	T	30	0.15	1.06	28	0.15	1.08	0 + 50	25	R 70	CMR 137	82.6 x 80 x 50	0.7	
TBC 87	7.42 - 7.72	T	32	0.2	1.08	22	0.2	1.15	0 + 60	25	5	F 70	UGF 70	82.6 x 80 x 29	0.45
TBC 74	7.35 - 7.85	T	32	0.2	1.05	25	0.2	1.10	0 + 55	25	10	R 70	CMR 137	82.6 x 80 x 50	0.7
TBX 01	7.5 - 8.5	T	25	0.2	1.15	20	0.3	1.20	0 + 60	25	5	R 84	UG 51/U	67 x 67 x 50	0.3
TBX 05	7.9 - 8.4	T	32	0.3	1.05	28	0.4	1.10	- 30 + 55	25	5	R 84	UER 84	57 x 65 x 57	0.26
TMX 11	8.2 - 10.5	T	21	0.3	1.20	20	0.4	1.20	- 20 + 120	25	5	R 100	UG 39/U	60 x 51.8 x 41	0.19
R 2908 D	8.2 - 10.3	200	40	0.15	1.1	40	0.15	1.1	+ 10 + 40	20	10	R 100	UG 39/U	41 x 51 x 59	0.125
R 2908 F	8.2 - 12.4	1500	23	0.2	1.15	20	0.3	1.2	- 32 + 85	20	10	R 100	UG 39/U	41 x 57 x 57	0.3
R 2908 B	8.5 - 10	T	20	0.25	1.2	20	0.25	1.2	- 30 + 85	20	10	R 100	UG 39/U	41 x 51 x 59	0.125
TMX 14	9.3 - 9.9	T	30	0.2	1.09	26	0.2	1.10	0 + 50	25	5	R 100	UG 39/U	60 x 51.8 x 41	0.19
TMX 10	10.5 - 12.2	T	25	0.3	1.15	20	0.5	1.20	+ 10 + 50	25	5	R 100	UG 39/U	60 x 51.8 x 41	0.19
TBX 231	10.7 - 11.7	T	30	0.2	1.07	26	0.2	1.12	- 20 + 60	25	5	R 120	UBR 120	44.5 x 44.5 x 38.1	0.19
F 10500	10.95 - 11.7	T	30	0.15	1.08	28	0.2	1.12	- 10 + 50	10	5	R 120	UBR 120	38 x 47.5 x 47.5	0.16
F 10501	10.95 - 11.7	T	30	0.15	1.1	27	0.15	1.15	0 + 40	50	5	R 120	UBR 120	38 x 47.5 x 47.5	0.16
F 10524	10.95 - 12	T	25	0.2	1.15	20	0.3	1.2	- 10 + 50	10	5	R 120	UBR 120	38 x 47.5 x 47.5	0.16
TBX 261	11.7 - 12.5	T	30	0.2	1.07	26	0.2	1.12	- 20 + 60	25	5	R 120	UBR 120	44.5 x 44.5 x 38.1	0.16
F 10511	12.4 - 12.6	T	25	0.25	1.15	25	0.3	1.15	0 + 50	5	5	R 140	UG 419/U	37 x 38 x 38	0.13
TBX 241	12.5 - 13.5	T	30	0.2	1.07	26	0.2	1.12	- 20 + 60	25	5	R 120	UBR 120	44.5 x 44.5 x 38.1	0.14
TBK 10	12.5 - 14	T	22	0.3	1.20	20	0.3	1.20	- 40 + 70	15	5	R 140	UG 419/U	38 x 40 x 35	0.14
F 10500 A	12.7 - 13.2	T	30	0.15	1.08	28	0.2	1.15	0 + 40	5	5	R 120	UBR 120	38 x 47.5 x 47.5	0.16
F 10525	13.5 - 14.5	T	25	0.25	1.12	20	0.3	1.2	- 10 + 50	5	5	R 120	UBR 120	38 x 47.5 x 47.5	0.16
R 2969 A	12.7 - 17	2000	20	0.4	1.2	20	0.4	1.2	- 40 + 70	5	5	R 140	UG 419/U	38 x 38 x 38	0.15
TBX 251	14 - 14.5	T	30	0.2	1.07	26	0.2	1.12	- 20 + 60	25	5	R 120	UBR 120	44.5 x 44.5 x 38.1	0.15
TBK 23	15 - 15.25	T	26	0.3	1.10	23	0.3	1.15	0 + 60	15	5	R 140	UG 419/U	38 x 40 x 35	0.14
TBK 21	15.5 - 17	T	22	0.3	1.20	20	0.3	1.20	0 + 60	15	5	R 140	UG 419/U	38 x 40 x 35	0.14
TBK 22	15.5 - 17	T	22	0.3	1.20	20	0.3	1.20	0 + 60	15	5	R 140	Haut. réduite	38 x 28 x 27	0.07
TBK 53	18 - 21	T	23	0.4	1.15	20	0.5	1.20	- 40 + 70	15	R 220	UG 597/U	32 x 32 x 25	0.08	
F 10558	18 - 22	T	23	0.4	1.2	20	0.5	1.25	- 10 + 50	2	2	R 220	UBR 220	38 x 47.5 x 47.5	0.16
F 10537	27 - 32	T	20	0.4	1.25	20	0.5	1.25	- 10 + 60	2	2	R 320	UG 381/U	40 x 36 x 36	0.205
F 10539	27 - 32	T	20	0.4	1.25	20	0.5	1.25	- 10 + 60	2	2	R 320	UG 599/U	30 x 31 x 24	0.08
F 10542	30 - 35	T	20	0.4	1.25	20	0.5	1.25	- 10 + 60	2	2	R 320	UG 381/U	40 x 36 x 36	0.205
F 10544	30 - 35	T	20	0.4	1.25	20	0.5	1.25	- 10 + 60	2	2	R 320	UG 599/U	30 x 31 x 24	0.08
F 10529	30 - 37	T	20	0.4	1.25	19	0.5	1.25	- 10 + 60	2	2	R 320	UG 381/U	40 x 36 x 36	0.405
F 10546	32 - 38	T	20	0.4	1.25	19	0.5	1.25	- 10 + 60	2	2	R 320	UG 381/U	40 x 36 x 36	0.405
R 2971 B	33 - 37	T	20	0.4	1.20	20	0.5	1.25	- 10 + 60	2	2	R 320	UG 599/U	30 x 31 x 24	0.080
F 10548	33 - 39	T	20	0.4	1.25	19	0.5	1.25	- 10 + 60	1	1	R 320	UG 381/U	40 x 36 x 36	0.405
TBK 71	33.8 - 34.3	T	20	0.4	1.15	20	0.5	1.20	- 40 + 70	15	R 220	UG 597/U	32 x 32 x 25	0.06	
F 10550	35 - 40	T	20	0.4	1.25	20	0.5	1.25	- 10 + 60	1	1	R 320	UG 381/U	40 x 36 x 36	0.205
TBK 70	35 - 38	T	20	0.4	1.20	20	0.5	1.20	0 + 50	15	R 320	UG 599/U	25 x 25 x 20	0.06	
F 10551	35 - 40	T	20	0.4	1.25	20	0.5	1.25	- 10 + 60	1	1	R 320	UG 599/U	40 x 36 x 36	0.205
F 10552	35 - 40	T	20	0.4	1.25	20	0.5	1.25	- 10 + 60	1	1	R 320	UG 599/U	30 x 31 x 24	0.08
F 10553	35 - 40	T	20	0.4	1.25	20	0.5	1.25	- 10 + 60	1	1	R 400	UG 383/U	40 x 36 x 36	0.205
F 10554	40 - 45	T	20	0.4	1.25	20	0.5	1.25	- 10 + 60	1	1	R 400	UG 383/U	40 x 36 x 36	0.205
F 10521	45 - 50	T	20	0.4	1.25	20	0.5	1.25	- 10 + 60	1	1	R 400	UG 383/U	40 x 36 x 36	0.405

T: Total T: full band

* Autres brides sur demande
Other flanges: please refer to THOMSON-CSF

f = 94 GHz: produits en développement, nous consulter.

f = 94 GHz: products in development, please refer to THOMSON-CSF

dispositifs sur guide waveguide devices

circulateurs sur guide, 4 voies 4 port waveguide circulators

TYPE TYPE	BANDE DE FRÉQUENCE FREQUENCY RANGE	BANDE PASSANTE BAND- WIDTH	CARACTÉRISTIQUES A SPECIFICATIONS AT				CARACTÉRISTIQUES DANS LA GAMME DE TEMPÉRATURES SPECIFICATIONS IN TEMPERATURE RANGE					GAMME DE TEMPE- RATURES TEMPE- RATURE RANGE	PUIS- SANCE MOYENNE MEAN POWER	PUIS- SANCE CRÊTE PEAK POWER	GUIDE WAVE- GUIDE	BRIDE FLANGE	DIMENSIONS DIMENSIONS	POIDS WEIGHT				
			T = 25 °C								°C								W	kW	mm	kg
			DÉCOU- PLAGE ISOLATION	PERTES INSERTION LOSS	R.O.S V.S.W.R	2-1 4-3	3-2 1-4	1-2 3-4	2-3 4-1	2-1 4-3												
HBC 141	3.4 - 3.8	T	25	50	0.2	0.4	1.07	22	45	0.2	0.4	1.10	0 + 50	150	10	R 40	CMR 229	254.2 x 121 x 50.8	1			
HBC 151	3.6 - 4.2	T	25	50	0.2	0.4	1.07	22	45	0.2	0.4	1.10	0 + 50	150	10	R 40	CMR 229	254.2 x 121 x 50.8	1			
HBC 31	4.4 - 4.8	T	22	45	0.3	0.6	1.20	18	40	0.4	0.8	1.20	+ 10 + 65	10	10	R 48	UG 49/U	120 x 230 x 92.5	4.5			
HBC 32	4.6 - 5	T	22	45	0.3	0.6	1.20	18	40	0.4	0.8	1.20	+ 10 + 65	10	10	R 48	UG 49/U	120 x 230 x 92.5	4.5			
AR 2971	5.85 - 8.2	T	20	40	0.3	0.6	1.25	20	40	0.3	0.6	1.25	0 + 40	10	10	R 70	UG 344/U	96 x 120 x 226	1.6			
HBX 01	7.5 - 8.5	T	23	40	0.2	0.4	1.15	18	35	0.3	0.5	1.20	0 + 60	25	5	R 84	UG 51/U	67 x 120 x 50	0.6			
R 2986	8.5 - 10	T	20	40	0.3	0.5	1.25	20	40	0.35	0.5	1.25	- 35 + 85	20	10	R 100	UG 39/U	41 x 59 x 90.3	0.32			
R 2986 A	10 - 12.2	900	20	40	0.3	0.6	1.20	20	40	0.3	0.6	1.25	- 35 + 85	20	10	R 100	UG 39/U	41 x 59 x 103	0.56			
HBX 20	10.7 - 11.7	T	20	35	0.3	0.5	1.15	18	35	0.3	0.5	1.20	- 20 + 90	5	5	R 120	UBR 120	38.1 x 87 x 44.5	0.32			
HBX 23	10.7 - 11.7	T	30	50	0.15	0.3	1.05	25	45	0.15	0.3	1.10	- 20 + 60	25	5	R 120	UBR 120	89 x 44.5 x 38.1	0.32			
F 10555	10.8 - 11.8	T	30	50	0.1	0.2	1.07	28	50	0.1	0.2	1.10	+ 10 + 50	1	1	R 120	UBR 120	47.5 x 38 x 95	0.32			
F 10513	12.4 - 14.4	T	20	40	0.25	0.5	1.20	20	40	0.25	0.5	1.25	0 + 50	10	5	R 120	UBR 120	38 x 47.5 x 95	0.32			
HBK 10	12.5 - 12.9	T	22	38	0.2	0.4	1.15	18	25	0.3	0.5	1.20	- 45 + 100	5	5	R 140	UG 419/U	38 x 73 x 33.5	0.29			
HBK 11	12.7 - 13.3	T	20	35	0.3	0.5	1.15	18	25	0.3	0.5	1.20	- 40 + 70	5	5	R 140	UG 419/U	38 x 73 x 33.5	0.29			
R 2996	14 - 16	1000	20	40	0.3	0.6	1.20	20	40	0.4	0.7	1.25	- 40 + 70	15	10	R 140	UG 419/U	35 x 45 x 78	0.26			
HBK 12	14.4 - 15.15	T	22	40	0.2	0.4	1.15	20	35	0.3	0.6	1.20	0 + 40	5	5	R 140	UG 419/U	38 x 73 x 33.5	0.26			
HBK 21	15.5 - 17	T	22	40	0.2	0.4	1.15	20	35	0.3	0.6	1.20	0 + 60	5	5	R 140	UG 419/U	38 x 73 x 33.5	0.26			

isolateurs à résonance resonance isolators

TYPE TYPE	BANDE DE FRÉQUENCE FREQUENCY RANGE	BANDE PAS- SANTE BAND- WIDTH	CARACTÉRISTIQUES A SPECIFICATIONS AT			CARACTÉRISTIQUES DANS LA GAMME DE TEMPÉRATURES SPECIFICATIONS IN TEMPERATURE RANGE					GAMME DE TEMPE- RATURES TEMPE- RATURE RANGE	PUIS- SANCE CRÊTE PEAK POWER	PUIS- SANCE MOYENNE MEAN POWER	GUIDE WAVE- GUIDE	BRIDE FLANGE	DIMENSIONS DIMENSIONS	POIDS WEIGHT						
			T = 25 °C															°C	W	kW	mm	kg	
			DÉCOU- PLAGE ISOLATION	PERTES INSERTION LOSS	R.O.S V.S.W.R	2-1 4-3	3-2 1-4	1-2 3-4	2-1 4-3	3-2 1-4													1-2 3-4
IBC 15	3.8 - 4.2	T	21	0.4	1.05	20	0.5	1.05	0 + 60	10	1	R 40	CMR 229	180 x 81 x 87	1.9								
R 2663	3.95 - 5.9	T	20	1	1.20	20	1	1.20	0 + 50	10	10	R 48	UG 149A/U	92 x 96 x 220	3								
R 2663A	4 - 5.9	1000	25	0.5	1.15	25	0.5	1.15	0 + 50	50	50	R 48	UG 149A/U	92 x 96 x 180	2.1								
IBC 31	4.4 - 4.8	T	22	0.5	1.10	20	0.6	1.12	+ 10 + 65	10		R 48	UG 149A/U	141 x 92 x 92	1.4								
IBC 32	4.6 - 5	T	22	0.5	1.10	20	0.6	1.12	+ 10 + 65	10		R 48	UG 149A/U	141 x 92 x 92	1.4								
R 2663 B	5.1 - 5.8	T	17	0.4	1.20	15	0.5	1.20	- 30 + 70	50	50	R 48	UG 149A/U	92 x 96 x 150	2								
R 2664	5.9 - 8.2	T	25	1	1.15	25	1	1.15	0 + 50	10	10	R 70	UG 344/U	80 x 90 x 220	2.2								
IBC 92	5.92 - 6.17	T	14	0.2	1.03	12	0.3	1.04	- 40 + 60	50		R 70	CPR 137	190 x 97 x 88	2.5								
IBC 93	6.17 - 6.42	T	14	0.2	1.03	12	0.3	1.04	- 40 + 60	50		R 70	CPR 137	190 x 97 x 88	2.5								
IBC 54	5.92 - 6.42	T	32	0.4	1.05	30	0.5	1.05	0 + 60	70		R 70	CMR 137	82.6 x 60 x 53.3	0.64								
IBC 87	6.4 - 6.76	T	14	0.2	1.03	12	0.3	1.04	- 40 + 60	70		R 70	CPR 137	190 x 97 x 88	2.5								
IBC 88	6.76 - 7.1	T	14	0.2	1.03	12	0.3	1.04	- 40 + 60	1		R 70	CPR 137	190 x 97 x 88	2.5								
IBC 76	6.5 - 7	T	28	0.4	1.05	25	0.6	1.10	0 + 55	1		R 70	CMR 137	100 x 60 x 70	1.10								
IBC 75	7.12 - 7.62	T	28	0.3	1.05	25	0.5	1.10	0 + 55	1		R 70	CMR 137	100 x 60 x 48	1								
IBC 95	7.13 - 7.62	T	28	0.3	1.05	25	0.5	1.10	0 + 55	1		R 84	UG 51/U	80 x 48 x 48	0.55								
IBC 74	7.35 - 7.85	T	28	0.4	1.05	25	0.5	1.10	0 + 55	1		R 70	CMR 137	100 x 60 x 48	1								
IBC 94	7.35 - 7.85	T	28	0.4	1.05	25	0.5	1.10	0 + 55	1		R 84	UG 51/U	80 x 48 x 48	0.55								
R 2652 A	7.5 - 9.6	T	18	0.9	1.15	15	1	1.15	- 30 + 70	10	10	R 84	UG 51/U	55 x 55 x 75	0.77								
R 2665 A	8.2 - 12.4	T	30	1	1.15	30	1	1.15	0 + 50	10	10	R 100	UG 39/U	88 x 70 x 180	3.4								
R 2605 A	8.2 - 12.4	1000	20	0.8	1.10	18	1	1.15	- 30 + 70	10	10	R 100	UG 39/U	50 x 50 x 75	0.72								
IBX 13	8.4 - 9	T				40	1.2	1.20	- 40 + 100	0.1		R 100	UG 39/U	77 x 48 x 44	0.5								
R 2606 A	8.5 - 9.6	T	40	0.8	1.15	40	0.8	1.15	+ 10 + 40	10	10	R 100	UG 39/U	68 x 70 x 150	2.8								
IBX 20	8.6 - 9.2	T	35	0.6	1.05	30	0.75	1.10	0 + 80	0.1		R 100	UG 39/U	96 x 48 x 44	0.5								
IBX 10	8.6 - 9.6	T	22	0.6	1.05	13	0.7	1.15	- 20 + 70	0.1		R 100	UG 39/U	77 x 48 x 44	0.5								
IBX 11	9 - 9.6	T	41	0.8	1.08	40	1.2	1.20	- 40 + 100	0.1		R 100	UG 39/U	77 x 48 x 44	0.5								
IBX 12	9.6 - 10.4	T	32	0.5	1.10	30	0.8	1.15	- 20 + 65	0.1		R 100	UG 39/U	77 x 48 x 44	0.5								
R 2673 B	12 - 18	1500	20	0.8	1.15	18	1	1.15	- 30 + 70	5	5	R 140	UG 419/U	52 x 60 x 66	0.55								
AR 2637	12.4 - 18	T	30	1	1.15	30	1	1.15	0 + 50	5	5	R 140	UG 419/U	80 x 80 x 120	1.3								
R 2673 A	16 - 18	T	17	0.9	1.15	15	1	1.15	- 55 + 125	5	5	R 140	UG 419/U	52 x 56.5 x 60	0.75								

T : total T : full band



HBC 141



R 2664



IBM 60



R 2690 K



IBX 55

isolateurs "cale" slimline isolators

TYPE TYPE	BANDE DE FREQUENCE RANGE GHz	BANDE PASSANTE BAND- WIDTH MHz	CARACTERISTIQUES A SPECIFICATIONS AT			CARACTERISTIQUES DANS LA GAMME DE TEMPERATURES SPECIFICATIONS IN TEMPERATURE RANGE			GAMME DE TEMPE- RATURES TEMPE- RATURE RANGE °C	PUISSANCE MOYENNE MEAN POWER W	PUISSANCE CRETE PEAK POWER kW	GUIDE WAVE- GUIDE	BRIDE FLANGE	DIMENSIONS DIMENSIONS mm	POIDS WEIGHT kg
			T = 25°C	DÉCOUPLAGE ISOLATION dB	Pertes INSERTION LOSS dB	R.O.S V.S.W.R	DÉCOUPLAGE ISOLATION dB	Pertes INSERTION LOSS dB							
IBC 57	5.9 - 6.4	200	20	0.5	1.2	18	0.5	1.4	-25+60	10	1	R 70	UG 344/U	25.4 x 89 x 80	0.3
IBC 60	6.4 - 7.1	2%	26	0.25	1.15	25	0.25	1.2	-20+50	10	1	R 70	UER 70	24.9 x 66.3 x 39.4	0.15
IBC 59	7.1 - 7.7	2%	26	0.25	1.15	25	0.25	1.2	-20+50	10	1	R 70	UER 70	24.9 x 66.3 x 39.4	0.15
IBX 50	8.2 - 10.5	2%	25	0.3	1.12	22	0.4	1.2	-25+65	10	1	R 100	UG 39/U	12.7 x 41 x 48	0.08
IBX 50	8.2 - 10.5	3%	20	0.4	1.25	18	0.4	1.3	-25+65	10	1	R 100	UG 39/U	12.7 x 41 x 48	0.08
R 2639	9 - 10	400	25	0.3	1.25	20	0.4	1.3	-32+85	2	7	R 100	UG 39/U	12 x 41 x 48	0.07
R 2666	10 - 12	400	25	0.3	1.25	20	0.4	1.3	-32+85	2	2	R 100	UG 39/U	12 x 41 x 48	0.07
IBX 55	10.4 - 11	3%	20	0.4	1.25	15	0.6	1.4	-25+65	10	1	R 100	UG 39/U	12.7 x 41 x 48	0.08
IBX 60	10 - 15	3%	20	0.3	1.20	18	0.4	1.3	-20+90	10	1	R 120	UBR 120	12.7 x 44.5 x 38	0.07
AR 2672	11 - 14	300	28	0.25	1.20	25	0.3	1.25	-10+60	1	1	R 120	UBR 120	11 x 38 x 46.5	0.07
IBK 50	12.4 - 13.3	3%	20	0.4	1.3	18	0.5	1.35	-45+90	10	1	R 140	UG 419/U	9.5 x 38 x 33.4	0.04
IBK 51	12.7 - 13.3	T	18	0.4	1.4	15	0.5	1.5	-40+70	10	1	R 140	UG 419/U	9.5 x 38 x 33.4	0.04
R 2690	12.7 - 17	500	25	0.4	1.3	20	0.5	1.35	0 + 50	1	5	R 140	UG 419/U	8 x 33.5 x 41	0.04
R 2690D	12.7 - 14.7	100	30	0.3	1.2	30	0.3	1.25	-40+85	1	5	R 140	UG 419/U	10 x 33.5 x 41	0.04
IBK 55	15.5 - 17	200	25	0.4	1.25	20	0.4	1.30	-45+90	10	1	R 140	UG 419/U	9.5 x 38 x 33.4	0.03
IBK 56	15.5 - 17	200	25	0.4	1.25	20	0.4	1.30	-45+90	10	1	R 140	UG 419/U	9.5 x 34.5 x 27	0.06
IBK 591	15.5 - 16.5	T	23	0.3	1.15	20	0.3	1.20	-40+85	10	1	R 140	UG 419/U	12.7 x 40 x 33.4	0.06
IBK 592	15.75 - 16.75	T	23	0.3	1.15	20	0.3	1.20	-40+85	10	1	R 140	UG 419/U	12.7 x 40 x 33.4	0.03
F 10001	19.5 - 24.5	500	30	0.3	1.20	25	0.4	1.25	-40+85	1	5	R 220	UG 595/U	12.5 x 25.5 x 25	0.04
IBK 65	21 - 24	200	25	0.4	1.10	20	0.5	1.20	-40+85	5	1	R 220	UG 595/U	12.7 x 22.2 x 22.2	0.04
F 10057A	30.8 - 32.8	2000	23	0.5	1.20	20	0.5	1.25	-10+60	1	1	WR 28	UG 599/U	15 x 36 x 31	0.06
IBK 70	32 - 40	1%	23	0.5	1.25	20	0.5	1.25	0 + 50	5	1	R 320	UG 599/U	12.7 x 32 x 19	0.03
F 10057	32.5 - 34.5	2000	23	0.5	1.20	20	0.5	1.25	-10+60	1	1	WR 28	UG 599/U	15 x 36 x 31	0.06
F 10057B	35 - 37	2000	23	0.5	1.20	20	0.5	1.25	-10+60	1	1	WR 28	UG 599/U	15 x 36 x 31	0.06
IBO 71	40 - 42	T	15	0.5	1.25	15	0.5	1.25	0 + 50	5	1	R 400	UG 383/U	12.7 x 19 x 25	0.03
F 10058	40 - 42	2000	23	0.5	1.20	20	0.5	1.25	-10+60	1	1	WR 22	UG 599/U modif.	15 x 36 x 31	0.06
F 10056A	49.5 - 50.5	1000	23	0.5	1.20	20	0.5	1.25	-10+60	1	1	WR 19	UG 599/U modif.	18 x 31.5 x 27	0.06
IBM 60	59 - 60	1000	23	0.6	1.20	20	0.6	1.25	-10+60	1	1	WR 15	UG 599/U modif.	18 x 31.5 x 27	0.06

T : total T : full band

isolateurs sur guide

Les circulateurs figurant dans les pages 63-64 peuvent être transformés en isolateurs par remplacement d'une sortie par une charge adaptée.

waveguide isolators

The circulators listed on pages 63-64 can be transformed into isolators by replacing on port by a matched load.

dispositifs de puissance high power devices

circulateurs coaxiaux, 3 voies 3 port coaxial circulators

TYPE TYPE	BANDE DE FRÉQUENCE RANGE GHz	BANDE PASSANTE BAND- WIDTH MHz	CARACTÉRISTIQUES A SPECIFICATIONS AT			CARACTÉRISTIQUES DANS LA GAMME DE TEMPÉRATURES SPECIFICATIONS IN TEMPERATURE			GAMME DE TEMPÉ- RATURES TEMPÉ- RATURE RANGE °C	PUISSANCE MOYENNE MEAN POWER W	PUISSANCE CRÊTE PEAK POWER KW	CONNEX- TEUR CONNEX- TOR	DIMENSIONS DIMENSIONS mm	POIDS WEIGHT kg
			DÉCOUPLAGE ISOLATION dB	Pertes INSERTION LOSS dB	R.O.S V.S.W.R	DÉCOUPLAGE ISOLATION dB	Pertes INSERTION LOSS dB	R.O.S V.S.W.R						
YHA 44	0.14 - 0.15	T	20	0.6	1.25	20	0.8	1.25	0 + 50	500	2	N	194 x 225 x 56	4.8
YHA 42	0.16 - 0.19	T	20	0.5	1.25	20	0.5	1.25	0 + 50	500	2	N	194 x 225 x 56	4.8
YMA 45	0.17 - 0.20	T	22	0.3	1.20	20	0.35	1.25	0 + 50	500	0.85	N	∅ 105 x 70	2
YHA 45	0.17 - 0.20	T	22	0.3	1.20	20	0.35	1.25	0 + 50	1000	1.8	HN	105 x 133.5 x 70	2
YHA 43	0.18 - 0.21	T	22	0.4	1.20	20	0.5	1.25	0 + 50	500	2	N	194 x 225 x 56	4.8
YHA 41	0.2 - 0.23	T	22	0.3	1.20	20	0.5	1.25	0 + 50	500	2	N	194 x 225 x 56	4.8
YMA 46	0.2 - 0.23	T	22	0.3	1.20	20	0.35	1.25	0 + 50	500	0.85	N	∅ 105 x 70	2
YHA 46	0.2 - 0.23	T	22	0.3	1.20	20	0.35	1.25	0 + 50	1000	1.8	HN	105 x 133.5 x 70	2
YHA 40	0.225 - 0.30	T	20	0.6	1.25	18	0.8	1.30	- 25 + 50	500	2	N	194 x 225 x 56	4.8
YHB 40	0.3 - 0.4	T	20	0.6	1.25	18	0.8	1.30	- 25 + 50	500	2	N	194 x 225 x 56	4.8
YBU 26	0.43 - 0.47	T	22	0.4	1.20	20	0.5	1.25	0 + 50	600	2	N	97 x 113 x 42	2.8
YBU 27	0.47 - 0.57	T	22	0.4	1.20	20	0.5	1.25	0 + 50	600	2	N	97 x 113 x 42	2.8
YHU 07	0.47 - 0.57	T	22	0.5	1.20	20	0.5	1.25	0 + 50	2000	4	1 5/8"	∅ 160 x 72	2.8
YBU 28	0.57 - 0.70	T	22	0.4	1.20	20	0.5	1.25	0 + 50	600	2	N	97 x 113 x 42	2.8
YHU 08	0.57 - 0.70	T	22	0.5	1.20	20	0.5	1.25	0 + 50	2000	4	1 5/8"	∅ 160 x 72	2.8
YBU 29	0.7 - 0.86	T	22	0.4	1.20	20	0.5	1.25	0 + 50	600	2	N	97 x 113 x 42	2.8
YHU 09	0.7 - 0.86	T	22	0.5	1.20	20	0.5	1.25	0 + 50	2000	4	N	∅ 160 x 72	2.8
R 2980	0.96 - 1.215	T	20	0.45	1.25	20	0.45	1.25	- 15 + 65	100	10	N	∅ 89 x 32	0.7
R 2921A	1.2 - 1.4	100	20	0.5	1.25	20	0.5	1.25	0 + 50	1000	40	1 5/8"	∅ 170 x 100	6
R 2921B	1.2 - 1.4	100	20	0.4	1.25	20	0.4	1.25	- 45 + 70	150	40	7/8"	106 x 92 x 65	2.5
F 30532	2.3 - 2.5	T	25	0.4	1.20	20	0.4	1.25	0 + 60	150	5	N	50 x 51 x 69	0.8
F 30511	2.4 - 2.5	T	20	0.3	1.25	20	0.3	1.25	- 10 + 40	2500	2.5	1 5/8"	106 x 70 x 83	3.8
F 30525	4.8 - 5.3	T	20	0.4	1.25	20	0.4	1.25	0 + 40	20	3	N	35 x 35 x 20	0.16

circulateurs sur guide, 3 voies 3 port, waveguide circulators

TYPE TYPE	BANDE DE FRÉQUENCE RANGE GHz	BANDE PASSANTE BAND- WIDTH MHz	CARACTÉRISTIQUES A SPECIFICATIONS AT			CARACTÉRISTIQUES DANS LA GAMME DE TEMPÉRATURES SPECIFICATIONS IN TEMPERATURE			GAMME DE TEMPÉ- RATURES TEMPÉ- RATURE RANGE °C	PUISSANCE MOYENNE MEAN POWER W	PUISSANCE CRÊTE PEAK POWER KW	GUIDE WAVE- GUIDE	BRIDE*** FLANGE	DIMENSIONS DIMENSIONS mm	POIDS WEIGHT kg
			DÉCOUPLAGE ISOLATION dB	Pertes INSERTION LOSS dB	R.O.S V.S.W.R	DÉCOUPLAGE ISOLATION dB	Pertes INSERTION LOSS dB	R.O.S V.S.W.R							
F 10573	2.45	50	25	0.08	1.15	20	0.15	1.20	+ 5 + 40	6000*	7	R 26	UG 553/U	191 x 180 x 134	6
F 10573A	2.45	50	25	0.08	1.15	20	0.15	1.20	0 + 30	3000*	3	R 26	UG 553/U	191 x 180 x 94	6
AR 2941C	2.7 - 2.9	T	20	0.4	1.20	20	0.4	1.20	- 20 + 60	700	700	R 32	CMR 284	145 x 163 x 190	4.1
AR 2941	2.7 - 3.3	200	20	0.3	1.15	20	0.3	1.20	- 10 + 60	1000	100	R 32	UG 584/U	145 x 163 x 190	4.1
TMS 361	2.85 - 3.30	T	20	0.3	1.20	20	0.3	1.20	- 10 + 65	1500	120	R 32	Spécial	180 x 170 x 102	4.5
AR 2941D	2.9 - 3.1	T	20	0.4	1.20	20	0.4	1.20	- 20 + 60	700	700	R 32	CMR 284	145 x 163 x 190	4.1
TMS 35	2.9 - 3.15	T	20	0.3	1.20	20	0.3	1.20	- 10 + 65	1500	120	R 32	Spécial	180 x 170 x 102	4.5
TMS 36	3.2 - 3.45	T	20	0.3	1.20	20	0.3	1.20	- 10 + 65	1500	120	R 32	Spécial	180 x 170 x 102	4.5
THC 34	4.4 - 5	T	25	0.2	1.15	20	0.3	1.15	- 10 + 50	1500	1.5	R 48	UER 48	120 x 120 x 74	1.9
AR 2953	5.35 - 5.85	T	20	0.3	1.25	20	0.3	1.25	0 + 55	400	400	R 48	UG 149 A/U	130 x 140 x 175	6.6
AR 2953A	5.35 - 5.85	T	20	0.25	1.20	18	0.3	1.30	0 + 55	1000	200	R 48	UG 149 A/U	130 x 140 x 175	7
AR 2985	5.9 - 6.4	T	25	0.3	1.10	20	0.3	1.20	- 20 + 60	300	30	R 70	CMR 137	80 x 82.6 x 50	0.5
THX 35	8.5 - 9.6	T	22	0.4	1.20	18	0.5	1.30	- 40 + 85	110	110	R 100	UG 39/U	60 x 51.8 x 41	0.19
F 10500C	14 - 14.5	T	25	0.1	1.15	20	0.2	1.20	- 10 + 50	200**	0.5	R 120	UG 419/U	80 x 47.5 x 38	0.3
F 10580	14 - 14.5	T	25	0.1	1.15	25	0.2	1.20	- 10 + 50	600**	1.5	R 120	UDR 120	61 x 90 x 63	0.7
F 10582	14 - 14.5	T	30	0.1	1.1	25	0.15	1.15	- 10 + 55	200*	0.2	R 120	UDR 120	61 x 55 x 55	0.35
THK 35	15.5 - 17	T	22	0.4	1.20	18	0.5	1.30	- 40 + 90	55	55	R 140	UG 419/U	38 x 40 x 35	0.14

T : total - T : full band

*Cl circuit - short circuited

**R.O.S = 3 - **V.S.W.R. = 3

*** Autres brides sur demande - Other flanges : please refer to THOMSON-CSF



YHU 09

F 10580

F 10573 A

HHK 36

DHX 23

F 10535 A

**circulateurs sur guide, 4 voies
4 port, waveguide circulators**

TYPE TYPE	BANDE DE FRÉQUENCE RANGE GHz	BANDE PASSANTE BAND- WIDTH MHz	CARACTÉRISTIQUES DANS LA GAMME DE TEMPÉRATURES SPECIFICATIONS IN TEMPERATURE RANGE					GAMME DE TEMPÉ- RATURES TEMPE- RATURE RANGE °C	PUISSANCE MOYENNE MEAN POWER W	PUISSANCE CRÊTE PEAK POWER kW	GUIDE WAVE- GUIDE	BRIDE** FLANGE	DIMENSIONS DIMENSIONS mm	POIDS WEIGHT kg
			DÉCOUPLAGE ISOLATION		PERTES INSERTION LOSS		R.O.S V.S.W.R							
			2-1 4-3	3-2 1-4	1-2 3-4	2-3 4-1								
HHK 35	8.5 - 9.6	T	18	35	0.3	0.6	1.3	-40 + 85	110	110	R 100	UG 39/U	60 x 106 x 41	0.45
HHK 35	15.5 - 17	T	18	35	0.5	1	1.3	-40 + 80	55	55	R 140	UG 419/U	38 x 80 x 35	0.3
HHK 35	15.6 - 16.3	T	20	40	0.3	0.6	1.2	-40 + 100	20	10	R 140	UG 419/U	38 x 75.8 x 35	0.3

T : total T : full band

**circulateurs à déphasage différentiel, sur guide, 4 voies
4 port, phase shift waveguide circulators**

TYPE TYPE	BANDE DE FRÉQUENCE RANGE GHz	BANDE PASSANTE BAND- WIDTH MHz	CARACTÉRISTIQUES A SPECIFICATIONS AT				T = 25°C	CARACTÉRISTIQUES DANS LA GAMME DE TEMPÉRATURES SPECIFICATIONS IN TEMPERATURE RANGE					GAMME DE TEMPÉ- RATURES TEMPE- RATURE RANGE °C	PUISSANCE MOYENNE MEAN POWER W	PUISSANCE CRÊTE PEAK POWER kW	GUIDE WAVE- GUIDE	BRIDE** FLANGE	DIMENSIONS DIMENSIONS mm	POIDS WEIGHT kg	
			DÉCOUPLAGE ISOLATION		PERTES INSERTION LOSS			R.O.S V.S.W.R	DÉCOUPLAGE ISOLATION		PERTES INSERTION LOSS									R.O.S V.S.W.R
			dB Em/Rec	Ant/Em	dB	dB			dB Em/Rec	Ant/Em	dB	dB								
F 10570	2.45	50	25	23	0.2	1.15	20	20	0.25	1.20	10 + 30	50,000*	50*	R 26	UG 553/U	1125x230x235	43			
(2)DHS32	2.9 - 3.2	T	25	25	0.4	1.2	25	25	0.4	1.2	0 + 50	3000	1000	R 32	Spécial	916x197x271	27			
(2)DHS331	2.9 - 3.1	T	25	25	0.4	1.2	25	25	0.4	1.20	0 + 50	10,000	660	R 32	Spécial	964.5x197x112	19			
R 2992	5.4 - 5.9	T	25	20	0.4	1.2	25	20	0.4	1.2	0 + 55	400	400	R 48	UG 149A/U	130x210x500	11			
R 2998	5.45 - 5.83	T	30	23	0.3	1.2	25	20	0.3	1.2	0 + 50	600	600	R 48	UG 149A/U	113x210x600	13			
R 2998C	5.45 - 5.83	T	25	20	0.3	1.2	25	17	0.3	1.2	0 + 50	5000	600	R 48	CPR 137 G	118x190x600	15			
R 2998A	5.45 - 5.83	T	25	20	0.4	1.2	25	17	0.4	1.2	0 + 50	2200	1100	R 48	CPR 137 G	118x190x600	13			
(4)DHC31	5.925 - 6.425	T	22	22	0.15	1.07	20	20	0.2	1.15	-10+65	1500		R 70	CPR 137 G	417.7x139x158	4.8			
DHC 32	5.925 - 6.425	T	22	22	0.15	1.07	20	20	0.2	1.15	-10 + 65	3000		R 70	CPR 137 G	417.7x139x158	4.8			
R 2997	5.92 - 6.42	T	30	25	0.25	1.15	25	20	0.3	1.2	0 + 60	3000	750	R 70	UG 344/U	105x160x540	12			
R 2997A	5.92 - 6.42	T	30	25	0.25	1.15	25	20	0.3	1.15	-20 + 60	2000	800	R 70	CMR 137/G	105x160x540	8			
R 2997D	5.92 - 6.42	T	30	25	0.25	1.15	25	20	0.3	1.15	-20 + 60	2000	300	R 70	CPR 137 F	100x160x540	8			
R 2997B	5.92 - 6.42	T	30	20	0.25	1.15	25	20	0.3	1.15	0 + 50	5000	200	R 70	CPR 137 G	105x138x540	12			
DHX 10	8.5 - 9.6	T	23	23	0.5	1.20	23	23	0.5	1.20	-40 + 70	300	250	R 84	UG 51/U	328x100x61	1.6			
DHX 20	8.5 - 9.6	T	22	22	0.4	1.20	20	20	0.5	1.20	-40 + 70	300	250	R 100	UG 39/U	152.5x60x54	0.52			
R 2900A	8.5 - 10.3	1000	25	20	0.4	1.2	25	20	0.5	1.2	-40 + 70	300	250	R 100	UG 39/U	61x75x240	0.52			
(2)R 2976	8.5 - 10.3	1000	25	20	0.35	1.2	25	20	0.35	1.15	0 + 50	2500	100	R 100	UG 39/U	61x75x240	2.1			
F 10559	8.5 - 9.6	200	25	25	0.4	1.15	25	25	0.4	1.15	0 + 60	250	250***	R 84	UG 138/U	250x60x70	0.7			
DHX 22	9 - 9.6	T	22	22	0.4	1.20	20	20	0.5	1.20	-40 + 70	540	180	R 100	UG 39/U	152.5x60x53.8	0.52			
R 2960	9.8 - 10.4	T	30	20	0.5	1.20	25	20	0.5	1.20	-40 + 70	300	250	R 100	UG 39/U	60x74x190	0.8			
DHX 23	9.9 - 10.5	T	22	22	0.3	1.20	20	20	0.5	1.20	-30 + 60	500		R 100	UG 39/U	207.5x108x105.8	1			
(2)DHX301	9.9 - 10.5	T					20	20	0.5	1.20	0 + 70	7000	7	R 100	UG 39/U	280x163x110	5.1			
F 10536	11.7 - 12.5	T	30	25	0.25	1.15	25	20	0.3	1.20	0 + 60	1000	2	R 120	UBR 120	56x70x257	2.2			
F 10535	14 - 14.5	T	30	28	0.25	1.15	30	25	0.3	1.15	0 + 80	2500	2.5	R 140	UG 419/U	90x120x230	3.2			
R 2968	16 - 18	1000	25	20	0.4	1.15	25	20	0.4	1.15	-50 + 125	150	150	R 140	UG 541/U	52x52x171	0.55			
AR 2939	16 - 18	1000	25	20	0.35	1.15	25	20	0.35	1.15	0 + 50	2000	75	R 140	UG 541/U	60x62x210	1.8			
(1)AR 2983	34.5 - 35.5	1000	25	20	0.5	1.20	25	20	0.5	1.20	-40 + 70	50	70	R 320	UG 599/U	50x45x140	0.46			
F 10576	29 - 31	T	25	20	0.6	1.20	25	20	0.5	1.20	-10 + 60	50	5	R 320	UG 599/U	150x60x50	0.38			
(1)AR 2983D	34.5 - 35.5	T	25	20	0.6	1.20	25	20	0.5	1.20	-10 + 85	50	50	R 320	UG 599/U UG 600/U	127x44x35	0.32			
F 10562	69.5 - 70.5	T	25	20	0.7	1.25	25	20	0.7	1.25	0 + 50	10	10	R 620	UG 385/U	88x50x55	0.3			

T : total T : full band *ct circuit - short circuited - *** R.O.S = 1.6 - *** V.S.W.R = 1.6 ** Autres brides sur demande - Other flanges : please refer to THOMSON-CSF

- (1) Pressurisé - Pressurized
- (2) Refroidi par eau - Liquid cooled
- (4) Refroidi par air - Air cooled

dispositifs de puissance high power devices



AR 2613



AR 2631

isolateurs à résonance resonance isolators

TYPE TYPE	BANDE DE FRÉQUENCE FREQUENCY RANGE	BANDE PASSANTE BAND- WIDTH	CARACTÉRISTIQUES A SPECIFICATIONS AT			CARACTÉRISTIQUES DANS LA GAMME DE TEMPÉRATURES SPECIFICATIONS IN TEMPERATURE RANGE			GAMME DE TEMPE- RATURES TEMPE- RATURE RANGE	PUIS- SANCE MOYENNE MEAN POWER	PUIS- SANCE CRÊTE PEAK POWER	GUIDE WAVE- GUIDE	SORTIES OUTPUTS	DIMENSIONS DIMENSIONS	POIDS WEIGHT
			T = 25 °C												
			DÉCOU- PLAGE ISOLATION dB	PERTES INSERTION LOSS dB	R.O.S V.S.W.R	DÉCOU- PLAGE ISOLATION dB	PERTES INSERTION LOSS dB	R.O.S V.S.W.R							
F 10007	1.215 - 1.37	T	10	0.7	1.20	10	0.7	1.20	0 + 50	1000	1000	R 14	UG 418 A/U	210 x 260 x 325	25
AR 2613 C	1.215 - 1.385	T	10	0.65	1.20	10	0.65	1.20	0 + 50	5000	4000	R 14	UG 417 1/U	210 x 250 x 591	45
AR 2613	1.215 - 1.385	T	10	0.65	1.20	10	0.65	1.20	0 + 50	5000	3000	R 14	UG 417 A/U	210 x 250 x 591	41
R 2668 B	2.6 - 3.4	T	19	0.4	1.20	17	0.7	1.20	- 30 + 70	50	100	R 32	CMR 284	92 x 132 x 220	3.7
IHS 60	2.9 - 3.1	T	8	0.6	1.15	8	0.6	1.15	- 20 + 40	1200	1200	R 32	CCTU n°7	200 x 180 x 135	10
F 10008	2.9 - 3.1	T	12	0.4	1.10	10	0.5	1.20	0 + 50	2000	1	R 32	CMR 284	320 x 250 x 220	19
AR 2631 B	2.9 - 3.1	100	25	0.35	1.10	20	0.5	1.10	0 + 50	2000	2000	R 32	CMR 284	135 x 160 x 250	15
AR 2631	2.9 - 3.1	100	15	0.35	1.10	10	0.5	1.10	0 + 50	2000	2000	R 32	UG 53/U	135 x 160 x 200	11.5
AR 2631 A	2.9 - 3.1	T	13	0.4	1.10	10	0.5	1.10	- 40 + 70	400	1200	R 32	UG 53/U	135 x 160 x 220	14
AR 2610	3.7 - 4.2	T	20	1	1.15	20	1	1.15	0 + 50	20	50	R 40	CMR 229	92 x 100 x 180	3.1
R 2648 A	4.8 - 6	T	17	0.5	1.10	10	0.5	1.10	- 50 + 100	550	50	R 48	UG 149 A/U	68 x 83 x 200	2.3
IHC 30	5.25 - 5.85	T				10	0.5	1.10	0 + 70	300	300	R 48	UG 149 A/U	224 x 104 x 92	4.6
R 2643 A	5.4 - 5.9	T	10	0.5	1.10	10	0.5	1.15	0 + 50	1500	1500	R 70	UG 344/U	92 x 100 x 150	3.5
R 2649	5.9 - 7.3	T	15	0.5	1.10	10	0.5	1.10	- 50 + 110	500	30	R 70	UG 344/U	80 x 9 x 170	1.9
R 2681	8.5 - 9.6	T	18	0.6	1.10	18	0.6	1.10	- 40 + 70	250	250	R 100	U 39/U	65 x 64 x 69	1.1
IMX 10	8.6 - 9.6	T	10	0.7	1.10	10	0.7	1.10	- 40 + 85	100	100	R 100	UG 39/U	40 x 62 x 53	0.60
IHX 40	8.5 - 10.5	T	10	0.5	1.20	10	0.5	1.20	- 10 + 100	300		R 100	UG 39/U	103 x 72 x 50	1.4
IHX 32	8.6 - 9.6	T	10	0.5	1.10	10	0.5	1.10	- 40 + 100	300	300	R 84	UG 51/U	63.5 x 50 x 60	1.14
IHX 30	8.6 - 9.6	T	10	0.65	1.10	10	0.65	1.10	- 40 + 85	300	300	R 84	UG 51/U	90 x 76 x 74	1.65
F 10004	9.27 - 9.47	T	20	0.35	1.10	20	0.4	1.10	- 32 + 85	80	80	R 84	UG 51/U	66 x 79 x 80	1.5
R 2681 A	9.8 - 10.8	T	20	0.6	1.05	20	0.6	1.05	- 40 + 70	300	250	R 100	UG 39/U	68 x 80 x 100	1.5
IHX 28	9.8 - 10.8	T	20	0.5	1.15	20	0.5	1.15	- 40 + 100	250	250	R 100	UG 39/U	82.6 x 65 x 50	1.25
R 2673	16 - 17	T	20	0.5	1.15	20	0.5	1.15	- 50 + 110	150	150	R 140	UG 419/U	58.5 x 63.5 x 64	0.9

T : total T : full band

dispositifs divers miscellaneous devices



F 52200

MI 002

jonctions non réciproques

Une jonction non réciproque est un dispositif à ferrite qui, en ajoutant des éléments d'adaptation, peut fonctionner en circulateur ou isolateur. Les éléments d'adaptation sont constitués des éléments répartis de la ligne (capacités parasites, capacités d'entrée ou de sortie des transistors) et des éléments localisés (capacités variables d'adaptation).

● Avantages

- réduction d'encombrement et de poids,
- montage sur le circuit sans fiches de raccordement,
- réduction de prix par rapport à un circulateur ou isolateur du type classique.

● Caractéristiques

Chaque type de jonction peut couvrir une octave entre 60 et 1200 MHz avec une bande passante instantanée de 3,5 % à 10 %.

Il existe des jonctions pouvant fonctionner dans une plus grande plage de température et supporter une puissance moyenne allant jusqu'à 100 W.

non-reciprocal junctions

A non-reciprocal junction is a ferrite device which can function as a circulator or an isolator when provided with matching network components. The matching network components are made up of line-distributed components (parasitic capacitances, transistor output or input capacitances) and local components (variable matching network capacitance).

● Advantages

- reduced weight and size,
- circuit assembly without connecting pins,
- low cost in relation to standard type isolator or circulator.

● Characteristics

Each type of junction can cover an octave bandwidth ranging between 60 and 1200 MHz with an instantaneous bandwidth of 3.5% to 10%. Some junctions can operate in a wider temperature range and withstand mean powers of up to 100 W.

jonctions non réciproques non reciprocal junctions

TYPE TYPE	BANDE DE FRÉQUENCE FREQUENCY RANGE GHz	BANDE PASSANTE BANDWIDTH %	CARACTÉRISTIQUES A SPECIFICATIONS AT T = 25°C			GAMME DE TEMPÉRATURES TEMPERATURE RANGE °C	PUISSANCE MOYENNE MEAN POWER W	CAPACITÉS TUNING CAPACITORS		DIMENSIONS DIMENSIONS mm
			DÉCOUPLAGE ISOLATION dB	PERTES INSERTION LOSS dB	R.O.S V.S.W.R			SÉRIE SERIE pF	PARALLÈLE PARALLEL pF	
F 52204	0.05 - 0.1	3.5	20	0.5	1.25	-20 + 70	50	8 - 40	10 - 50	40 x 40 x 15
JNR 03	0.1 - 0.15	3.5	20	1	1.25	-10 + 60	20	0 - 60	0 - 60	12.7 x Ø 25.4
F 52205	0.1 - 0.2	3.5	20	0.5	1.25	-20 + 70	30	5 - 20	5 - 30	40 x 40 x 15
F 52205 A	0.1 - 0.2	3.5	20	0.5	1.25	-20 + 70	20	5 - 20	5 - 30	31 x 31 x 4.5
JNR 04	0.15 - 0.3	3.5	20	1	1.25	-10 + 60	20	0 - 35	0 - 35	12.7 x Ø 25.4
F 52200 R	0.15 - 0.3	3.5	20	1	1.25	-20 + 70	20	5 - 20	5 - 30	28 x 28 x 16
F 52201 R	0.2 - 0.4	3.5	20	1	1.25	-20 + 70	20	5 - 20	5 - 30	28 x 28 x 16
JNR 041	0.225 - 0.4	3.5	20	1	1.25	-10 + 60	20	0 - 35	0 - 35	12.7 x Ø 25.4
F 52202 R	0.3 - 0.6	3.5	20	1	1.25	-20 + 70	20	5 - 20	5 - 30	28 x 28 x 16
JNR 06	0.4 - 0.6	3.5	20	0.8	1.25	-10 + 60	20	0 - 35	0 - 35	12.7 x Ø 25.4
JNR 07	0.6 - 0.96	3.5	20	0.6	1.25	-10 + 60	20	0 - 10	0 - 10	12.7 x Ø 25.4
JNR 08	0.96 - 1.2	3.5	20	0.4	1.25	-10 + 60	20	0 - 5	0 - 5	12.7 x Ø 25.4

isolateurs intégrables en microélectronique integrable microelectronic isolators

TYPE TYPE	BANDE DE FRÉQUENCE FREQUENCY RANGE GHz	DÉCOUPLAGE ISOLATION dB	PERTES INSERTION LOSS dB	R.O.S V.S.W.R	GAMME DE TEMPÉRATURES TEMPERATURE RANGE °C	DIMENSIONS DIMENSIONS mm
MI 005	3.15 - 3.9	17	0.5	1.4	0 + 50	17 x 17 x 6
MI 002	3.6 - 4.2	18	0.4	1.4	0 + 60	17 x 17 x 6
MI 006	5.85 - 6.45	18	0.5	1.4	0 + 60	17 x 17 x 6
MI 001	6.35 - 7.1	20	0.5	1.3	0 + 60	17 x 17 x 6
MI 007	7 - 7.9	18	0.5	1.4	0 + 60	17 x 17 x 6
MI 012	7.6 - 8.5	18	0.5	1.4	0 + 60	17 x 17 x 6

dispositifs divers miscellaneous devices

commutateurs à ferrites (circulateurs + commande) ferrite switches (circulators + control)

TYPE TYPE	BANDE DE FREQUENCE RANGE GHz	BANDE PASSANTE BAND- WIDTH MHz	DÉCOUPLAGE ISOLATION dB min	Pertes D'INSERTION LOSS dB max	R.O.S V.S.W.R	COURANT DE COMMANDE CONTROL CURRENT mA max	TEMPS DE COMMUTATION SWITCHING TIME ms	GAMME DE TEMPÉRATURES TEMPERATURE RANGE °C	PUISSANCE MOYENNE MEAN POWER W max	PUISSANCE CRÊTE PEAK POWER kW max	BRIDE FLANGE CONNECTEUR CONNECTOR	GUIDE WAVEGUIDE	DIMENSIONS DIMENSIONS mm	POIDS WEIGHT kg
R 2922 A	2.7 - 3.4	T	20	0.4	1.2	200	1.5	0 + 50	10	10	UG 53/U	R 32	165 x 175 x 135	
F 11005	2.425 - 2.475	T	20	0.25	1.15	2000	1000	+ 10 + 30	20 kW (2)	50	UG 553/U	R 26	1000 x 235 x 260	60
F 11003	2.95 - 3.05	T	20	0.3	1.15	1000	1000	+ 10 + 40	6 kW	6 MW (1)	CPR 284 F	R 32	635 x 273 x 194	45
R 2978 B	4 - 4.6	T	23	0.25	1.1	150	0.25	- 55 + 85	1	1	Coaxial		∅ 37 x 36	0.15
F 11000	8.5 - 9.6	T	20	0.5	1.25	1400	30	- 40 + 70	200	200	UG 39/U	R 100	81 x 93 x 176	1.6
R 2763	8.5 - 10	T	20	0.3	1.2	200	3	- 40 + 70	10	1	UG 39/U	R 100	51 x 59 x 60	0.25
F 11002	8.5 - 9.6	300	20	0.5	1.2	800	0.5	- 40 + 70	80	40 (2)	UG 39/U	R 100	225.4 x 90 x 80	1.4
F 11001	9 - 9.2	T	30	0.4	1.15	1400	30	- 10 + 60	250	250	UG 51/U	R 84	80 x 90 x 242	1.7
R 2764	12.7 - 17	1000	20	0.4	1.15	100	0.3	- 40 + 70	5	1	UG 419/U	R 140	∅ 60 x 60	0.4
F 11004 A	15 - 17	300	20	0.2	1.20	200	1	- 40 + 70	100	2	UG 419/U	R 140	40 x 46 x 50	0.22
R 2761	34.7 - 35.2	T	23	0.6	1.25	45	3	0 + 50	1	1	UG 599/U	R 320	52 x 65 x 90	0.5

T : total T : full band

(1) pressurisation = 2 kg SF6

(2) court-circuit short circuited

(3) R.O.S V.S.W.R = 3

filtres à grenat d'yttrium YIG filters

TYPE TYPE	FREQUENCE FREQUENCY GHz	BANDE PASSANTE BANDWIDTH MHz	Pertes D'INSERTION LOSS dB	DÉCOUPLAGE HORS RÉSON. OFF RESON. ISOLATION dB min	RÉJECTION DES PARASITES OFF RESON. SPURIOUS REJECTION dB min	LINÉARITÉ LINEARITY MHz	HYSTÉRÉSIS HYSTERESIS MHz	SENSIBILITÉ D'ACCORD TUNING SENSITIVITY MHz/mA	DIMENSIONS DIMENSIONS mm	POIDS WEIGHT kg
FILTRES 2 ÉTAGES - 2 STAGES FILTERS										
F 31800	0.5 - 1	20 - 35	3	50	30	± 2	3	17	35.5 x 35.5 x 35.5	0.240
F 31801	1 - 2	20 - 35	3	50	30	± 2	4	17	35.5 x 35.5 x 35.5	0.240
F 31802	2 - 4	20 - 40	3	50	25	± 3	6	17	35.5 x 35.5 x 35.5	0.240
F 31803	4 - 8	25 - 45	3	50	25	± 5	10	17	35.5 x 35.5 x 35.5	0.240
F 31804	8 - 12.4	25 - 50	3	50	25	± 7	14	17	35.5 x 35.5 x 35.5	0.240
F 31805	12.4 - 18	30 - 60	3	45	25	± 10	18	22	41 x 41 x 46	0.450
FILTRES 2 ÉTAGES LARGE BANDE - 2 STAGES WIDEBAND FILTERS										
F 31840	0.5 - 2	18 - 40	4	50	30	± 4	8	17	35.5 x 35.5 x 35.5	0.240
F 31841	1.8 - 12.4	20 - 55	4	50	25	± 8	16	25	35.5 x 35.5 x 35.5	0.240
F 31842	8 - 18	30 - 75	4	50	25	± 12	20	22	41 x 41 x 46	0.450
FILTRES DOUBLES 2 ÉTAGES - DUAL 2 STAGES FILTERS										
F 31830	0.5 - 1	20 - 35	3	50	30	± 2	3	17	35.5 x 35.5 x 35.5	0.240
F 31831	1 - 2	20 - 35	3	50	30	± 2	4	17	35.5 x 35.5 x 35.5	0.240
F 31832	2 - 4	20 - 40	3	50	25	± 3	6	17	35.5 x 35.5 x 35.5	0.240
F 31833	4 - 8	25 - 45	3	50	25	± 5	10	17	35.5 x 35.5 x 35.5	0.240
F 31834	8 - 12.4	25 - 50	3	50	25	± 7	14	17	35.5 x 35.5 x 35.5	0.240
F 31835	12.4 - 18	30 - 60	3	45	25	± 10	18	22	41 x 41 x 46	0.450
FILTRES 4 ÉTAGES - 4 STAGES FILTERS										
F 31820	0.5 - 1	15 - 30	6	70	60	± 2	3	17	35.5 x 35.5 x 35.5	0.240
F 31821	1 - 2	18 - 36	6	70	60	± 2	4	17	35.5 x 35.5 x 35.5	0.240
F 31822	2 - 4	20 - 40	5	70	50	± 3	6	17	35.5 x 35.5 x 35.5	0.240
F 31823	4 - 8	25 - 50	5	70	50	± 5	10	17	35.5 x 35.5 x 35.5	0.240
F 31824	8 - 12.4	25 - 50	5	70	50	± 7	14	17	35.5 x 35.5 x 35.5	0.240
F 31825	12.4 - 18	30 - 60	5	70	50	± 10	18	22	41 x 41 x 46	0.450
F 31850	12 - 18	150 - 300	5	70	50	± 10	18	22	41 x 41 x 46	0.450

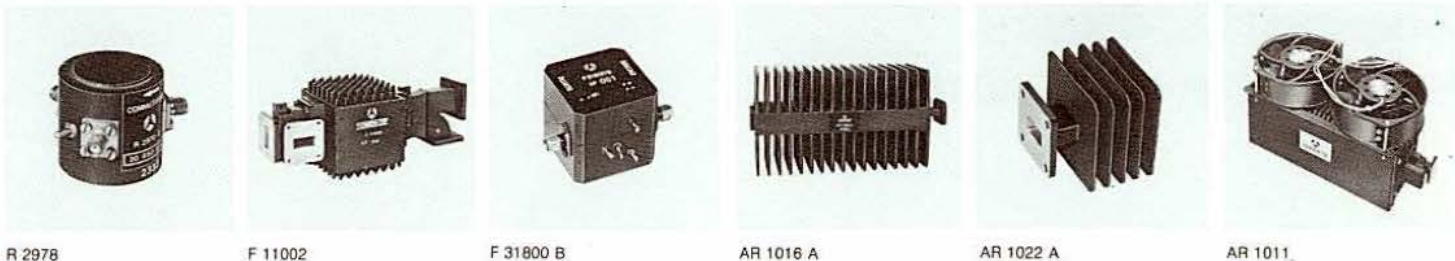

R 2978

F 11002

F 31800 B

AR 1016 A

AR 1022 A

AR 1011

charges de puissance - absorbant céramique high power loads - dissipating material : ceramic

TYPE TYPE	BANDE DE FRÉQUENCE FREQUENCY RANGE GHz	R.O.S. V.S.W.R. max	PUISSANCE POWER		GUIDE WAVEGUIDE	BRIDE FLANGE	DIMENSIONS DIMENSIONS mm	POIDS WEIGHT kg
			CW W max	CRÊTE PEAK KW max				
AR 2876	2.4 - 2.5	1.10	2000	1000	R 26	UG 554/U	592 x 203 x 160	10
AR 2869	2.6 - 3.3	1.15	250	750	R 32	UG 584/U	250 x 135 x 135	2.5
AR 2869 A	2.6 - 3.3	1.15	250	750	R 32	CMR 284	250 x 135 x 135	2.5
AR 2877	5.3 - 6	1.10	1000	500	R 48	UG 149 A/U	440 x 120 x 120	8
AR 2854	5.4 - 5.9	1.10	250	500	R 48	UG 149 A/U	250 x 140 x 110	1.5
AR 2853 C	5.8 - 6.7	1.10	50	50	R 70	UG 344/U	180 x 80 x 80	0.8
AR 1001	5.8 - 6.7	1.07	200	200	R 70	CMR 137	180 x 80 x 80	0.8
AR 2853 B	5.8 - 6.7	1.07	200	200	R 70	UG 344/U	220 x 80 x 80	1.2
AR 1009	5.8 - 6.45	1.07	200	200	R 70	CMR 137	220 x 80 x 80	1.2
AR 2853 E	5.8 - 6.45	1.07	200	200	R 70	CPR 137 F	220 x 80 x 80	1.2
AR 1000	5.9 - 8.2	1.10	1000	400	R 70	CPR 137 G	440 x 120 x 120	8
AR 1000 A	5.9 - 8.2	1.10	1000	400	R 70	UG 344/U	440 x 120 x 120	8
AR 1000 B	5.9 - 8.2	1.10	1000	400	R 70	CPR 137 F	440 x 120 x 120	8
AR 1000 C	5.9 - 8.2	1.10	1000	400	R 70	CMR 137	440 x 120 x 120	8

charges de puissance high power loads

TYPE TYPE	BANDE DE FRÉQUENCE FREQUENCY RANGE GHz	R.O.S. V.S.W.R. max	PUISSANCE POWER		GUIDE WAVEGUIDE	BRIDE FLANGE	DIMENSIONS DIMENSIONS mm	POIDS WEIGHT kg
			CW W max	CRÊTE PEAK KW max				
AR 1028	7.9 - 8.4	1.10	1000	300	R 84 WR 112	UG 51/U	286 x 161 x 128	6.5
AR 2879	7 - 10.5	1.10	300	300	R 84	UG 51/U	350 x 80 x 80	1.5
R 2862	8.2 - 12.4	1.10	10	10	R 100	UG 39/U	120 x 41 x 41	0.32
R 2863	8.2 - 12.4	1.10	50	50	R 100	UG 39/U	120 x 60 x 60	0.55
R 2864	8.2 - 12.4	1.10	250	250	R 100	UG 39/U	292 x 60 x 102	2.3
AR 1024	10 - 15	1.10	150	120	R 120	UDR 120	170 x 70 x 70	0.4
AR 1016 A	10 - 15	1.10	800	120	R 120	UDR 120	326 x 128 x 161	6.5
AR 1016	10 - 15	1.10	800	120	R 120	UBR 120	326 x 128 x 161	6.5
R 2865	12.4 - 18	1.10	100	100	R 149	UG 419/U	125 x 70 x 70	0.3
R 2865 A	12.4 - 18	1.10	150	100	R 140	UG 419/U	180 x 70 x 70	0.4
AR 1012	12.4 - 18	1.10	500	100	R 140	UG 419/U	285 x 104 x 128	6
AR 1011 (2)	14 - 14.5	1.10	3000	50	R 140	UG 419/U	329 x 150 x 200	7.5
AR 1011 B (2)	14 - 14.5	1.10	3000	60	R 120	UDR 120	337 x 150 x 200	7.5
AR 1011 A (2)	14 - 14.5	1.10	3000	60	R 120	UDR 120	337 x 150 x 200	7.5
AR 1022 A	16 - 17	1.10	10	10	R 140 WR 62	UG 419/U	50 x 40 x 40	0.1
AR 1026 (1)	34 - 36	1.10	10	10	RG 96/U		50 x 40 x 40	0.08

(1) pressurizable 2.5 Kg/cm²
pressurizable 2.5 Kg/cm²

(2) ventilateur incorporé
fan incorporated

charges de puissance refroidies par eau water cooled high power loads

TYPE TYPE	BANDE DE FRÉQUENCE FREQUENCY RANGE GHz	R.O.S. V.S.W.R. max	PUISSANCE POWER		GUIDE WAVEGUIDE	BRIDE FLANGE	DIMENSIONS DIMENSIONS mm	POIDS WEIGHT kg
			CW W max	CRÊTE PEAK KW max				
AR 1025 (2)	2.44 - 2.46	1.20	5000	1000	R 26	UG 553/U	140 x 125 x 103	1.35
AR 1010 (2)(2)	2.93 - 3.01	1.10	8000	8000	R 32	CPR 284 G	179 x 462 x 77	6.2
AR 1008 (2)	2.90 - 3.10	1.15	5000	1000	R 32	CPR 284 F	115 x 125 x 94	1.2
AR 2853 (1)	5.9 - 8.2	1.10	3000	400	R 70	UG 344/U	440 x 80 x 80	7
AR 2879 A (1)(2)	7 - 11	1.10	2000	300	R 84	UG 51/U	300 x 70 x 48	7
R 2864 A (1)	8.2 - 12.4	1.10	3000	250	R 100	UG 39/U	310 x 60 x 60	3.5

(1) absorbant céramique
dissipating material : ceramic

(2) absorbant eau
dissipating material : water

(3) pressurizable
pressurizable AR 1010 2 Kg/cm² SF6

dispositifs divers

miscellaneous devices

charges bas niveau

low power loads

TYPE TYPE	BANDE DE FRÉQUENCE FREQUENCY RANGE GHz	R.O.S V.S.W.R. max	PUISSANCE POWER		GUIDE WAVEGUIDE	BRIDE FLANGE	DIMENSIONS DIMENSIONS mm	POIDS WEIGHT kg
			CW W max	CRÊTE PEAK KW max				
AR 2868	2.2 - 3.3	1.02	12	12	R 26	UG 553	520	4.5
R 2856	2.6 - 3.95	1.02	10	10	R 32	UG 53/U	425	3.2
CBC 14	3.4 - 3.9	1.10	1	0.1	R 40	CMR 229	11 x 82 x 50.8	0.2
CBC 15	3.6 - 4.2	1.10	1	0.1	R 40	CMR 229	100 x 80.2 x 50.8	0.55
CBC 16	3.8 - 4.2	1.05	1	0.1	R 40	CMR 229	11 x 82 x 50.8	0.20
R 2853	3.95 - 5.85	1.02	5	5	R 48	UG 149 A/U	275	1.1
R 2857	4.9 - 7.05	1.02	4	4	R 58	CMR 159	250	0.85
R 2857 A	4.9 - 7.05	1.02	4	4	R 58	CPR 159	250	0.85
R 2861	5.4 - 8.2	1.02	2.5	2.5	R 70	UG 344/U	200	0.65
R 2861 A	5.4 - 8.2	1.02	2.5	2.5	R 70	CPR 137 F	200	0.65
CBC 54	5.9 - 6.4	1.06	1	0.1	R 70	CMR 137	58 x 40 x 10	0.06
CBC 78	6.4 - 7.1	1.06	1	0.1	R 70	CMR 137	58 x 40 x 10	0.06
R 2851	7 - 10	1.02	1.5	1.5	R 84	UG 51/U	150	0.32
CBC 74	7.35 - 7.85	1.10	1	0.1	R 70	CMR 137	70 x 60 x 40	0.20
CBX 02	7.75 - 8.5	1.05	1	0.1	R 84	UG 51/U	95 x 47.6 x 47.6	0.06
R 2850	8.2 - 12.4	1.02	1	1	R 100	UG 39/U	130	0.18
CBX 13	9 - 9.6	1.05	1	0.1	R 100	UG 39/U	41 x 41 x 7.6	0.03
CBX 10	10.5 - 12.2	1.05	1	0.1	R 100	UG 39/U	41 x 41 x 40	0.09
CBX 26	11.7 - 12.5	1.07	1	0.1	R 120	UBR 120	44.5 x 38.1 x 12.7	0.05
CBX 24	12.5 - 13.25	1.07	1	0.1	R 120	UBR 120	44.5 x 38.1 x 12.7	0.05
AR 2850	12.4 - 18	1.02	0.5	0.5	R 140	UG 419/U	95	0.12
CBK 11	12.7 - 13.3	1.05	1	0.1	R 140	UG 419/U	33.3 x 33.3 x 30	0.06
CBK 21	15.5 - 17	1.05	1	0.1	R 140	UG 419/U	33.3 x 33.3 x 30	0.05
AR 1002 A	26.5 - 40	1.05	0.3	0.3	R 320	UG 599	40	0.05
AR 1003 A	26.5 - 40	1.08	0.3	0.3	R 320	UG 599	20	0.04
AR 1007	26.5 - 40	1.08	0.3	0.3	R 320	UG 381/U	20	0.04
AR 1004	33 - 50	1.05	0.2	0.2	R 400	UG 383/U	40	0.05
AR 1005	33 - 50	1.06	0.2	0.2	R 400	UG 383/U	20	0.04
AR 1014	40 - 60	1.05	0.1	0.1	R 500	UG 383/U	40	0.05
AR 1015	60 - 90	1.08	0.1	0.1	R 740	UG 387/U	35	0.04

matériaux céramique hyperfréquence

microwave ceramic materials

THOMSON-CSF, produit et commercialise l'une des gammes les plus complètes de matériaux ferrite performants destinés aux dispositifs hyperfréquence fonctionnant dans la bande de 100 MHz à 50 GHz. Cette gamme comprend :

- des ferrites de manganèse magnésium et de nickel;
- des grenats d'yttrium aluminium gadolinium;
- des grenats pour puissances crêtes élevées;
- des grenats à faible largeur de raie de gyrorésonance;
- des ferrites de lithium.

Les céramiques hyperfréquence proposées sont largement employées dans les systèmes électroniques de THOMSON-CSF (faisceaux hertziens, réseaux de télécommunications, radars embarqués et de surface, etc...) vendus et installés dans plus de 80 pays. Leur production se fait en étroite collaboration avec les Ingénieurs et Techniciens du LABORATOIRE CENTRAL de RECHERCHES (L.C.R.) de THOMSON-CSF et à l'aide des équipements de tests et de mesures du L.C.R. Cette activité de THOMSON-CSF a été placée dans un environnement scientifique et industriel tel que les équipes chargées du développement et de la production des matériaux céramiques hyperfréquence sont capables d'étudier les applications les plus innovatrices et de mettre en œuvre les méthodes de fabrication, d'essais et de mesures les plus efficaces.

THOMSON-CSF manufactures and markets one of the most complete ranges of high performance ferrite materials for microwave devices functioning in the 100 MHz to 50 GHz bandwidth. This range includes :

- *nickel and magnesium manganese ferrites*
- *yttrium gadolinium aluminium garnets*
- *high peak power garnets*
- *narrow gyromagnetic resonance linewidth garnets*
- *lithium ferrites.*

The microwave ceramic materials presented are widely used in THOMSON-CSF electronic systems (radio links, telecommunication networks, ground and on-board radars, etc.) sold and installed in more than 80 countries. Production is done in close collaboration with the engineers and technicians of THOMSON-CSF Central Research Laboratory (L.C.R.) and is carried out with test and measurement equipment developed by L.C.R.

This activity of THOMSON-CSF has been placed in an industrial and scientific environment so that the teams entrusted with the development and production of microwave ceramic materials may study the most modern applications, using the most efficient measurement, testing and manufacturing procedures.

symboles

M_s	AIMANTATION A SATURATION
T_c	POINT DE CURIE
G_{eff}	FACTEUR GYROMAGNÉTIQUE EFFICACE
ΔH	LARGEUR DE RAIE DE RÉSONANCE
ΔH_{eff}	LARGEUR DE RAIE EFFECTIVE
ΔH_k	LARGEUR DE RAIE D'ONDE DE SPIN
ϵ'	PERMITTIVITÉ
$tg \delta$	PERTE DIÉLECTRIQUE
α	CŒFFICIENT MOYEN DE STABILITÉ DE L'AIMANTATION (- 20 °C + 60 °C)

symbols

SATURATION MAGNETIZATION
CURIE POINT
EFFECTIVE LANDÉ FACTOR
GYROMAGNETIC RESONANCE LINEWIDTH
EFFECTIVE RESONANCE LINEWIDTH
SPINWAVE RESONANCE LINEWIDTH
PERMITTIVITY
DIELECTRIC LOSS
MAIN MAGNETIZATION TEMPERATURE CŒFFICIENT (- 20 °C + 60 °C)

matériaux céramique hyperfréquence microwave ceramic materials

grenats garnets

TYPE TYPE	$4 \pi J_s$ (gauss)	M_s (kA/m)	T_c (°C)	g_{eff}	ΔH (Oe)	ΔH (kA/m)	ΔH_{eff} (Oe)	ΔH_{eff} (kA/m)	ΔH_k (Oe)	ΔH_k (kA/m)	c	10^4 $tg \delta_c$	$10^3 \alpha$ (°C ⁻¹)
YTTRIUM-ALUMINIUM													
Y 10	1790	142.5	280	2.00	45	3.6	4	0.3	2	0.15	15.4	<2	2.2
Y 35	1200	95.5	225	2.01	40	3.2	4	0.3	2	0.15	15.0	<2	2.6
Y 34	1000	79.6	210	2.01	40	3.2	4	0.3	2	0.15	14.9	<2	2.7
Y 39	800	63.7	195	2.01	40	3.2	4	0.3	2	0.15	14.7	<2	3.1
Y 38	760	60.5	190	2.01	40	3.2	4	0.3	2	0.15	14.6	<2	2.9
Y 37	680	54.1	180	2.01	40	3.2	4	0.3	2	0.15	14.6	<2	2.9
Y 33	615	49.0	175	2.01	40	3.2	4	0.3	2	0.15	14.6	<2	3.2
Y 30	565	45.0	160	2.01	35	2.8	4	0.3	2	0.15	14.5	<2	3.2
Y 32	420	33.4	135	2.01	35	2.8	4	0.3	2	0.15	14.5	<2	3.2
Y 31	370	29.5	125	2.01	35	2.8	4	0.3	2	0.15	14.2	<2	4.1
Y 36	290	23.1	115	2.01	30	2.4	4	0.3	2	0.15	14.1	<2	4.6
YTTRIUM-GADOLINIUM													
Y 11	1600	127.4	280	2.00	60	4.8	5	0.4	3	0.2	15.4	<2	1.8
Y 12	1420	112.9	280	2.01	65	5.2	6	0.5	6	0.5	15.4	<2	1.5
Y 13	1250	99.5	280	2.01	75	6.0	8	0.6	8	0.6	15.4	<2	1.0
Y 14	1100	87.5	280	2.02	95	7.6	12	1.0	9	0.7	15.5	<2	0.5
Y 15	900	71.6	280	2.03	140	11.1	18	1.4	11	0.9	15.5	<2	0.7
YTTRIUM-GADOLINIUM-ALUMINIUM													
Y 71	1020	81.2	235	2.01	60	4.8	7	0.6	5	0.4	15.1	<2	2.2
Y 710	1020	81.2	240	2.02	75	6.0	9	0.7	7	0.6	15.1	<2	1.7
Y 77	950	75.6	230	2.01	60	4.8	6	0.5	5	0.4	15.0	<2	2
Y 78	800	63.7	220	2.00	80	6.4	8	0.6	8	0.6	15.1	<2	1.3
Y 708	800	63.7	260	2.04	140	11.1	15	1.2	15	1.2	15.3	<2	0.5
Y 74	670	53.3	190	2.01	60	4.8	6	0.5	6	0.5	15.0	<2	2.3
Y 72	540	43.0	175	2.01	60	4.8	6	0.5	6	0.5	14.7	<2	2.3
Y 705	470	37.4	170	2.2	65	5.2	6	0.5	6	0.5	14.4	<2	2.8
Y 75	400	31.8	160	2.03	65	5.2	6	0.5	6	0.5	14.4	<2	2.7
Y 76	390	31.0	160	2.02	50	4.0	6	0.5	6	0.5	14.3	<2	3.4
FORTES PUISSANCES - HIGH POWER													
D 1	1400	111.4	270	2.00	110	8.8	34	2.7	16	1.3	15.5	<2	1.4
D 5	1070	85.2	270	2.02	150	11.9	36	2.9	23	1.8	15.5	<2	0.5
Y 91	1020	81.2	240	2.02	60	4.8	17	1.3	14	1.1	15.2	<2	1.3
D 2	900	71.6	270	2.01	185	14.7	25	2.0	24	1.9	15.5	<2	0.8
Y 86	830	66.1	270	2.03	95	7.6	34	2.7	25	2.0	15.5	<2	1.2
Y 94	780	62.1	250	2.02	75	6.0	14	1.1	23	1.8	15.3	<2	0.3
Y 908	780	62.1	250	2.02	85	6.8	14	1.1	29	2.3	15.3	<2	0.3
D 3	590	47.0	175	2.00	85	6.8	16	1.3	19	1.5	14.5	<2	3.5
D 4	580	46.2	170	2.00	140	11.1	34	2.7	33	2.6	14.4	<2	3.0
FAIBLE LARGEUR DE RAIE - NARROW LINEWIDTH													
Y 220	1950	155.2	205	2.01	*10	*0.8	2	0.2	1	0.1	15.5	<2	3.1
Y 219	1900	151.2	240	2.02	*25	*2	4	0.3	2	0.15	15.2	<2	2.6
Y 101	1800	144.9	280	2.00	*20	*1.6	4	0.3	2	0.15	15.4	<2	2.2
Y 215	1450	115.4	240	2.01	*10	*0.8	2	0.2	1	0.1	14.8	<2	2.7
Y 209	900	71.6	180	2.01	*10	*0.8	2	0.2	1	0.1	14.2	<2	3.5

*mesuré sur une sphère à polissage optique

*measured on an optically polished sphere

ferrite
ferrite

TYPE TYPE	$4 \pi J_s$ (gauss)	M_s (kA/m)	T_c (°C)	g_{eff}	ΔH (Oe)	ΔH (kA/m)	ΔH_{eff} (Oe)	ΔH_{eff} (kA/m)	ΔH_k (Oe)	ΔH_k (kA/m)	ϵ'	10^{-4} $\lg \delta_\epsilon$	$10^{-3} \alpha$ (°C ⁻¹)
MAGNÉSIUM													
U 21	2400	191.0	275	2.03	290	23.1	6	0.5	4	0.3	13.0	<3	2.7
U 20	2100	167.2	300	2.01	360	28.7	6	0.5	4	0.3	13.0	<3	2.3
U 33	1600	127.4	230	2.02	290	23.1	8	0.6	4	0.3	12.4	<3	3.3
U 32	1400	111.4	210	2.01	260	20.7	8	0.6	4	0.3	12.1	<3	3.7
U 30	1130	89.9	175	2.00	180	14.3	9	0.7	5	0.4	12.0	<3	4.5
NICKEL													
N 25	3200	254.7	560	2.30	250	19.9	100	8.0	26	2.1	12.7	<6	1
N 40	3100	246.8	560	2.30	370	29.5	130	10.3	34	2.7	12.5	<6	0.8
N 28	2750	218.9	550	2.30	330	26.3	100	8.0	24	1.9	12.4	<6	0.8
N 41	2500	199.0	530	2.30	370	29.5	130	10.3	35	2.8	12.3	<6	0.7
N 24	2500	199.0	530	2.30	400	31.8	15	1.2	12	1.0	13.0	<6	0.7
N 26	2350	187.1	520	2.30	300	23.9	100	8.0	35	2.8	12.2	<6	0.7
N 27	2200	175.1	500	2.30	330	26.3	100	8.0	25	2.0	11.8	<6	0.9
N 21	2100	167.1	500	2.40	400	31.8	15	1.2	12	1.0	12.6	<6	1.0
N 42	1900	151.2	480	2.30	350	27.9	130	10.3	36	2.9	11.4	<6	1.0
N 29	1400	111.4	450	2.40	380	30.2	100	8.0	40	3.2	11.2	<6	0.8
LITHIUM													
A 50	5000	398.0	450	2.06	170	13.5	4	0.3	3	0.25	15.3	<5	1.6
A 37	3700	294.5	565	2.08	400	31.8	4	0.3	3	0.25	16.0	<5	1.0
A 370	3700	294.5	565	2.07	400	31.8	7	0.55	6	0.50	15.9	<5	1.0
A 30	3000	238.8	555	2.08	450	35.8	4	0.3	3	0.25	16.4	<5	0.8
A 28	2800	222.9	540	2.08	450	35.8	4	0.3	3	0.25	16.6	<5	0.9
A 23	2300	183.1	505	2.08	450	35.8	4	0.3	3	0.25	16.8	<5	1.2
A 230	2300	183.1	505	2.08	450	35.8	9	0.70	8	0.60	16.6	<5	1.2

NOTA : Courant 1981, il est prévu de commercialiser de nouveaux matériaux diélectriques stables en température ($\epsilon' = 36$).
NOTE : New dielectric materials will be available during 1981 (high stability with temperature, $\epsilon' = 36$).

réflecteurs et lentilles de luneberg
luneberg reflectors and lenses

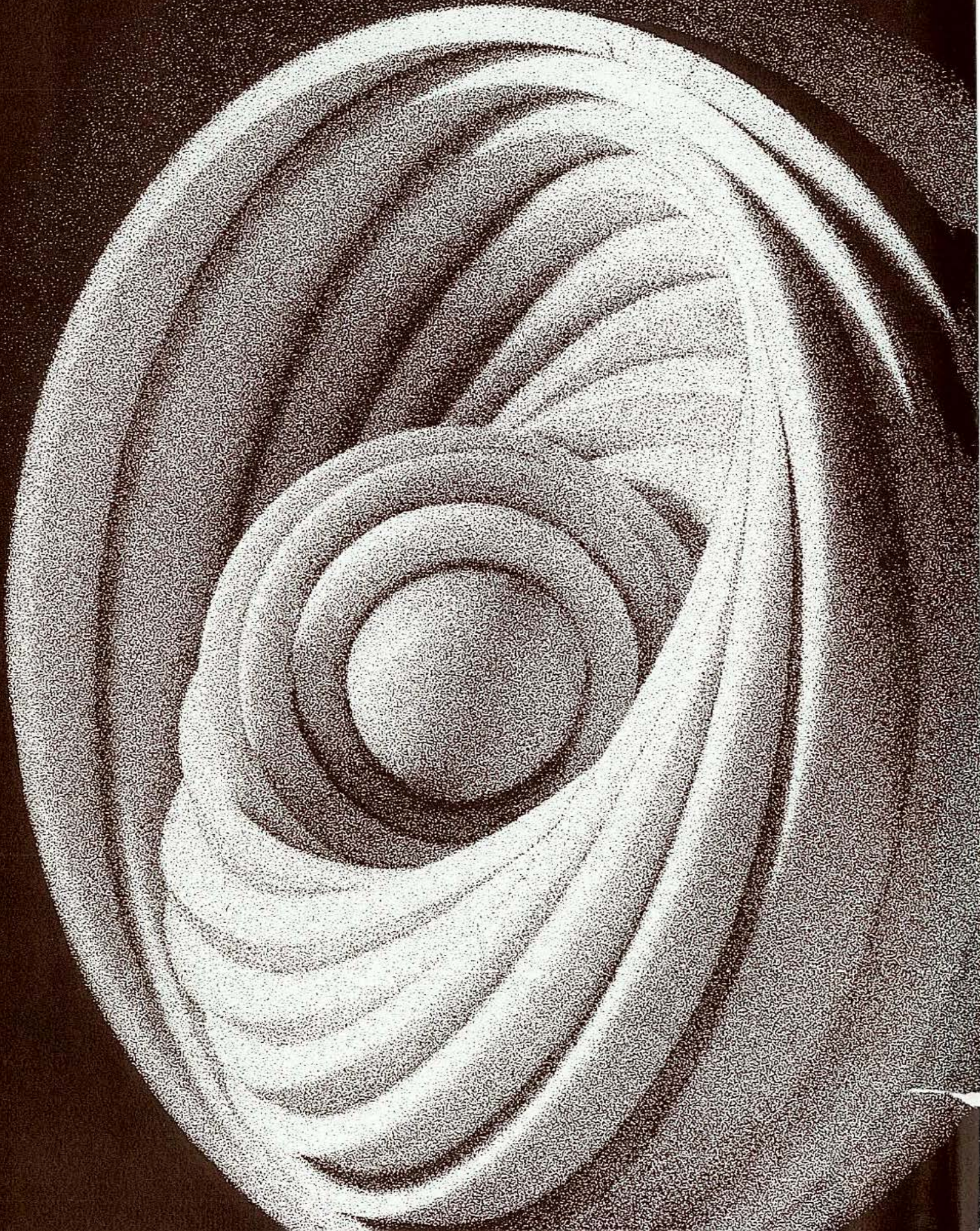

réflecteurs et lentilles de luneberg

luneberg reflectors and lenses

Les réflecteurs de Luneberg permettent d'augmenter de façon sensible la surface d'écho radar d'une cible.

A titre d'exemple, une sphère métallisée de 18 cm de diamètre présente une surface d'écho de 0,25 m²; à 9 GHz un réflecteur de Luneberg, de diamètre identique présente une surface équivalente de 5,5 m²; l'écho reçu est multiplié par 20.

La surface d'écho radar σ d'un réflecteur de Luneberg varie suivant la formule approchée.

$$\sigma \simeq 5.6 \frac{\phi^4}{\lambda^2} \quad (1)$$

Les graphiques en annexe (cf. compléments techniques) résument les réponses des différents types de réflecteurs.

) ϕ diamètre du réflecteur
 λ longueur d'onde

Luneberg reflectors make it possible to increase the target radar echo surface considerably. For example, a 18 cm diameter metal sphere has a 0.25 m² echo surface. At 9 GHz, a Luneberg reflector of identical diameter offers an equivalent surface of 5.5 m²; the echo received is multiplied by 20. The σ radar echo surface of a Luneberg reflector varies according to the following approximate formula :

$$\sigma \simeq 5.6 \frac{\phi^4}{\lambda^2} \quad (1)$$

Appended graphs (see design aid) summarize the response of the various types of reflectors.

(1) reflector diameter
 λ wavelength

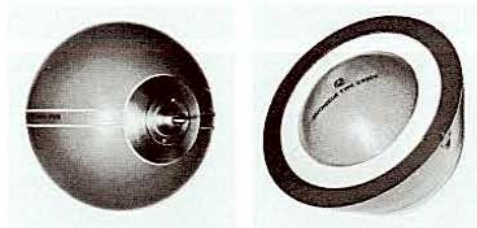

D 6210

D 6306

réflecteurs et lentilles de luneberg

luneberg reflectors and lenses



D 6363

réflecteurs de luneberg

luneberg reflectors

TYPE TYPE	DIAMÈTRE MAX. DU RÉFLECTEUR SANS FIXATION MAX. DIAMETER OF REFLECTOR WITHOUT FIXING DEVICE (cm)	SURFACE D'ÉCHO TYPIQUE DANS L'AXE TYPICAL SCATTERING CROSS SECTION ALONG THE AXIS AT 9375 MHz (m ²)	TYPE DE RÉPONSE TYPE OF RESPONSE	ZONE DE RÉPONSE ZONE OF RESPONSE	POLARISATION POLARIZATION	TYPE DE FIXATION FIXING DEVICE	POIDS WEIGHT kg
D 6372	10	0.65	monostatique <i>monostatic</i>	cône ± 70°	rectiligne <i>rectilinear</i>		0.25
D 6360	12.5	1.2	monostatique <i>monostatic</i>	cône ± 70°	rectiligne <i>rectilinear</i>		0.4
D 6358	18	5.5	monostatique <i>monostatic</i>	cône ± 70°	rectiligne <i>rectilinear</i>		1.3
D 6316 A	18	5.5	monostatique <i>monostatic</i>	cône ± 70°	rectiligne <i>rectilinear</i>	2	1.4
D 6327 A	18	5.5	monostatique <i>monostatic</i>	cône ± 70°	rectiligne <i>rectilinear</i>	3	2.4
D 6376	18	1.7 : plan équatorial <i>equatorial plane</i> 0.5 : 18°	mono à ceinture <i>monostatic belt type</i>	équat. zone ± 20°	rectiligne <i>rectilinear</i>		1.3
D 6376 A	18	1.7 : plan équatorial <i>equatorial plane</i> 0.5 : 18°	mono à ceinture <i>monostatic belt type</i>	équat. zone ± 20°	rectiligne <i>rectilinear</i>		2
D 6374	18	2.2 : 0° 0.7 : 10°	bistatique <i>bistatic</i>	cône ± 70°	rectiligne <i>rectilinear</i>		1.3
D 6374 A	18	2.2 : 0° 0.7 : 10°	bistatique <i>bistatic</i>	cône ± 70°	rectiligne <i>rectilinear</i>	2	1.4
D 6392 A	18	2.2	monostatique <i>monostatic</i>	cône ± 50°	circulaire <i>circular</i>	2	1.4
D 6338	23.5	16	monostatique <i>monostatic</i>	cône ± 70°	rectiligne <i>rectilinear</i>		2.9
D 6380	23.5	4 : plan équatorial <i>equatorial plane</i> 1.5 : 18°	mono à ceinture <i>monostatic belt type</i>	équat. zone ± 20°	rectiligne <i>rectilinear</i>		2.9
D 6339	23.5	7 : 0° 2 : 10°	bistatique <i>bistatic</i>	cône ± 70°	rectiligne <i>rectilinear</i>		2.9
D 6342	26	23	monostatique <i>monostatic</i>	cône ± 70°	rectiligne <i>rectilinear</i>		3.8
D 6352	26	23	monostatique <i>monostatic</i>	cône ± 60°	rectiligne <i>rectilinear</i>		3.8
D 6306	26	20	monostatique <i>monostatic</i>	cône ± 70°	rectiligne <i>rectilinear</i>	1	5.2
D 6310 A	26	23	monostatique <i>monostatic</i>	cône ± 70°	rectiligne <i>rectilinear</i>	2	3.9
D 6351	26	7 : plan équatorial <i>equatorial plane</i> 2.5 : 18°	mono à ceinture <i>monostatic belt type</i>	équat. zone ± 20°	rectiligne <i>rectilinear</i>		3.8
D 6351 A	26	7 : plan équatorial <i>equatorial plane</i> 2.5 : 18°	mono à ceinture <i>monostatic belt type</i>	équat. zone ± 20°	rectiligne <i>rectilinear</i>		3.8
D 6357	26	10 : 0° 3 : 10°	bistatique <i>bistatic</i>	cône ± 70°	rectiligne <i>rectilinear</i>		3.6
D 6334	26	10 : 0° 3 : 10°	bistatique <i>bistatic</i>	cône ± 60°	rectiligne <i>rectilinear</i>		3.6
D 6319 A	26	10 : 0° 3 : 10°	bistatique <i>bistatic</i>	cône ± 70°	rectiligne <i>rectilinear</i>	2	3.7
D 6348	32	45	monostatique <i>monostatic</i>	cône ± 60°	rectiligne <i>rectilinear</i>		7.5
D 6382	32	45	monostatique <i>monostatic</i>	cône ± 70°	rectiligne <i>rectilinear</i>		7.5
D 6377	32	15 : plan équatorial <i>equatorial plane</i> 5 : 18°	mono à ceinture <i>monostatic belt type</i>	équat. zone ± 20°	rectiligne <i>rectilinear</i>		7.5
D 6377 A	32	15 : plan équatorial <i>equatorial plane</i> 5 : 18°	mono à ceinture <i>monostatic belt type</i>	équat. zone ± 10°	rectiligne <i>rectilinear</i>	2	7.8
D 6375	32	20 : 0° 6 : 10°	bistatique <i>bistatic</i>	cône ± 70°	rectiligne <i>rectilinear</i>		7.5
D 6368	44.5	100	monostatique <i>monostatic</i>	cône ± 70°	rectiligne <i>rectilinear</i>		20
D 6369	44.5	30 : plan équatorial <i>equatorial plane</i> 10 : 18°	mono à ceinture <i>monostatic belt type</i>	équat. zone ± 20°	rectiligne <i>rectilinear</i>		20
D 6378	44.5	35 : 0° 10 : 10°	bistatique <i>bistatic</i>	cône ± 20°	rectiligne <i>rectilinear</i>		20
D 6363	61	250	monostatique <i>monostatic</i>	cône ± 70°	rectiligne <i>rectilinear</i>		50
D 6363 A	61	250	monostatique <i>monostatic</i>	cône ± 70°	rectiligne <i>rectilinear</i>	4	57

réflecteurs et lentilles de luneberg

luneberg reflectors and lenses



D 6209

lentilles de luneberg

luneberg lenses

TYPE TYPE	DIAMÈTRE MAXIMUM MAXIMUM DIAMETER cm	GAIN A 9375 MHz GAIN AT 9375 MHz dB	POIDS WEIGHT kg	SYSTÈME DE FIXATION FIXING DEVICE
D 6215	10	18	0.25	RG 52/U
D 6209	18	23.5	1.3	
D 6214	23.5	25.5	2.9	
D 6205 A	26	26.5	3.9	
D 6206	26	26.5	3.8	
D 6210	32	28.5	7.5	
D 6213	44.5	30.5	20	

types de fixation

fixing devices

unités : mm
units : mm

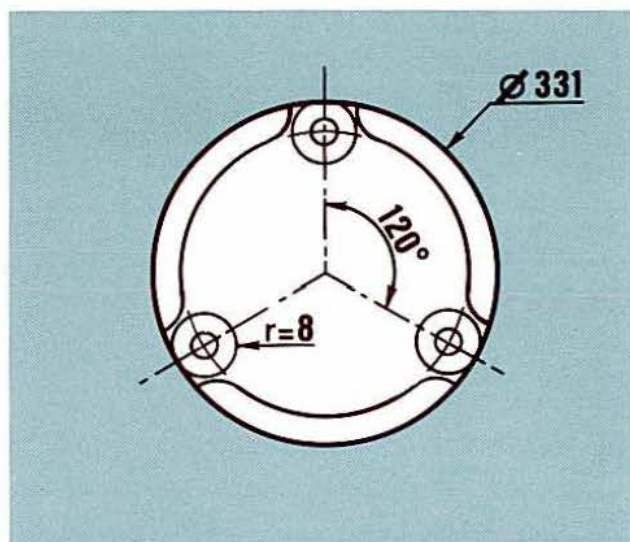

1
3 trous Ø 6,2 sur Ø 319
matière : céloron 2T
3 holes Ø 6,2 on Ø 319
material : céloron 2T

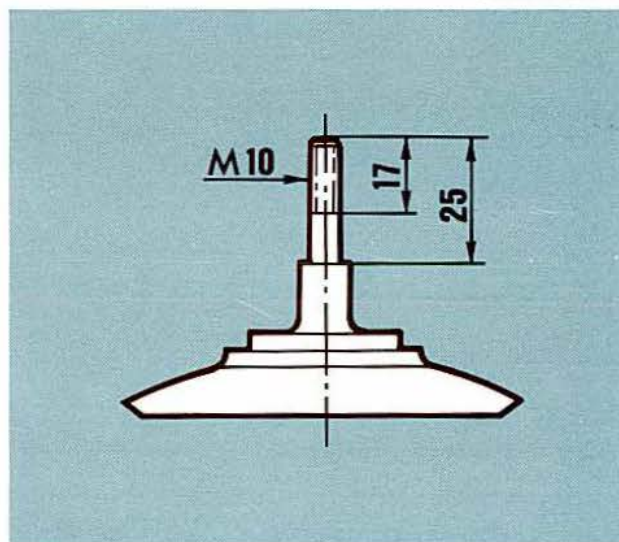

2
matière : AU 4G
material : AU 4G

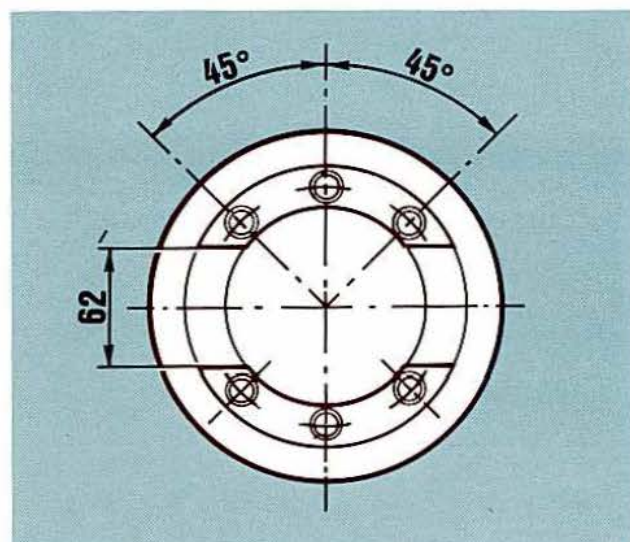

3
6 trous M6 sur Ø 110
matière : AU 4G
6 holes M6 on Ø 110
material : AU 4G

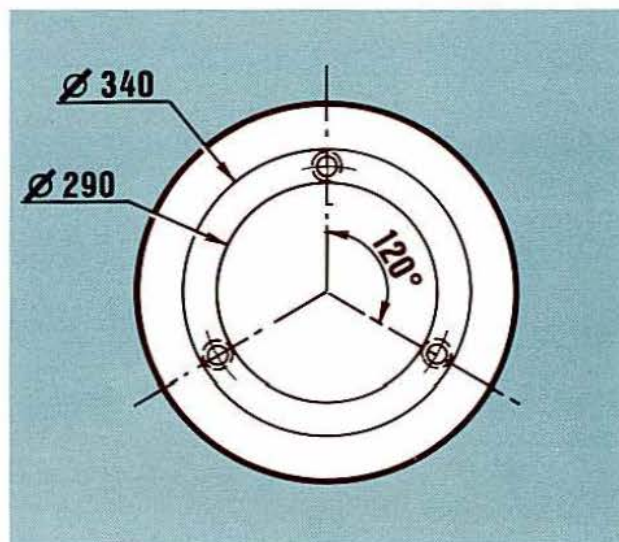

4
3 trous M10 sur Ø 315,32
matière : fonderie
3 holes M 10 on Ø 315,32
material : casting

compléments techniques design aid

influence d'un isolateur sur le R.O.S.
effect of an isolator on V.S.W.R.

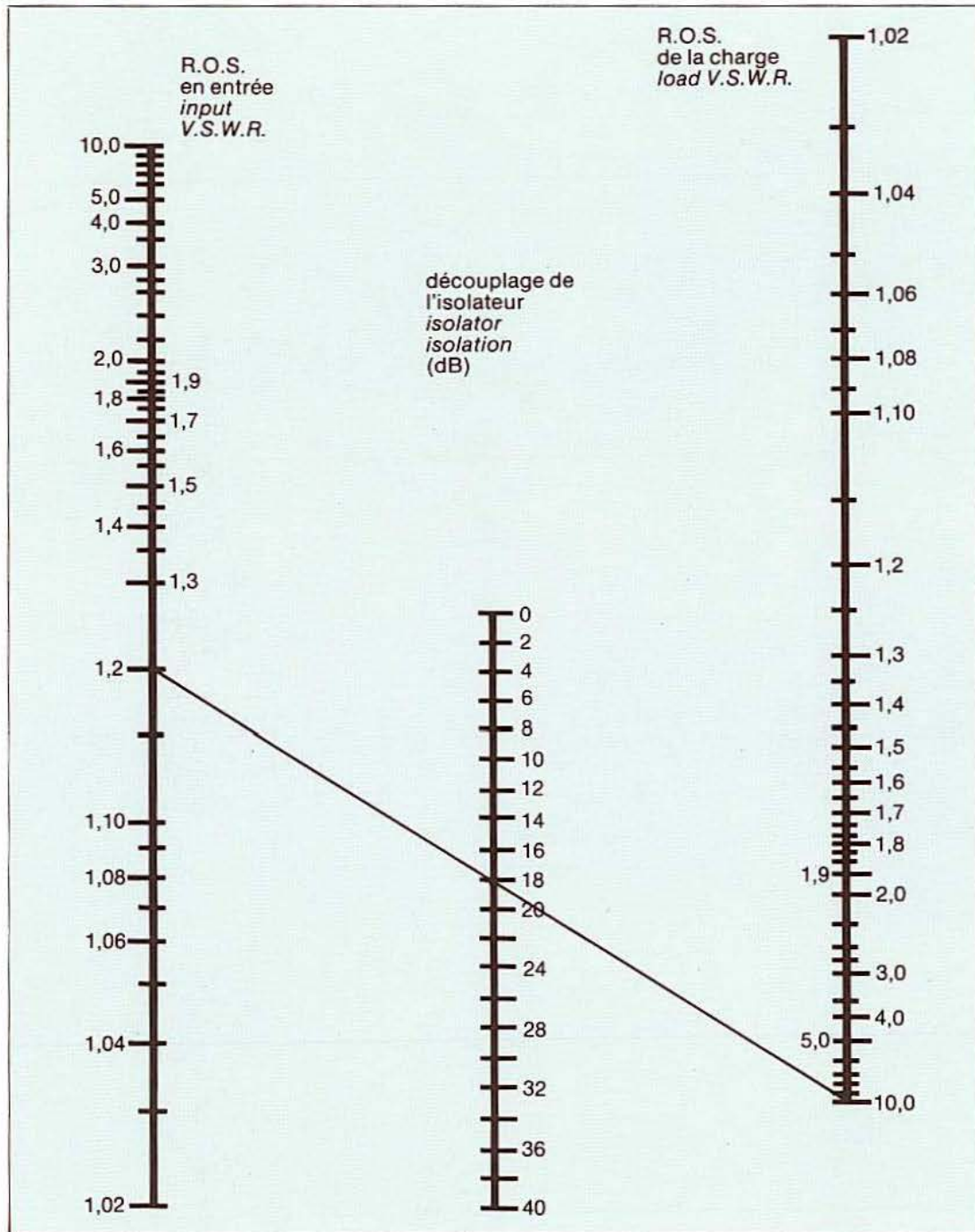

R.O.S. à l'entrée
input V.S.W.R.



ex : R.O.S. de la charge : 10
load V.S.W.R.

Découplage isolateur : 18 dB
Isolator isolation

Sur l'abaque on lit le R.O.S. à l'entrée : 1.2
By means of this nomograph we read the input V.S.W.R. : 1.2

compléments techniques

design aid

influence du R.O.S. sur la puissance transmise
effect of V.S.W.R. on transmitted power

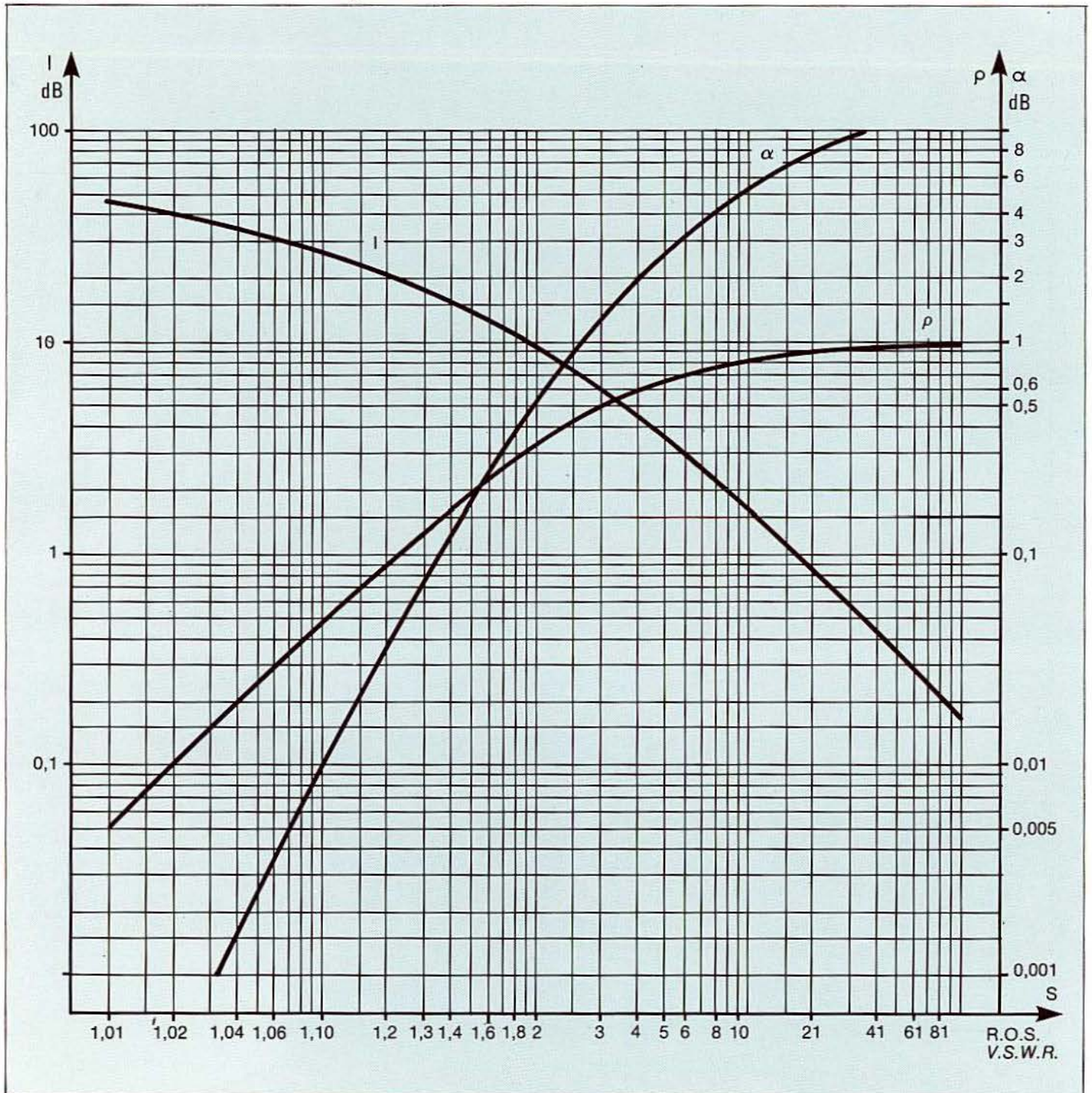

S : R.O.S.
 V.S.W.R.

ρ : coefficient de réflexion en tension
 voltage reflection coefficient

I : pertes à la réflexion
 return loss

α : pertes à la transmission
 transmission loss

$$\rho = \frac{S-1}{S+1} \quad S = \frac{1+\rho}{1-\rho} \quad I = 20 \log \frac{S+1}{S-1} \quad \alpha = 10 \log \frac{(1+S)^2}{4S}$$

compléments techniques design aid

réflecteurs de luneberg luneberg reflectors

réponse type d'un réflecteur monostatique classique (Ø 26 cm) en fonction de la largeur 2α du cône de réponse à 9375 MHz

typical response of a monostatic reflector (Ø 26 cm) in terms of the angle 2α of the response cone at 9375 MHz

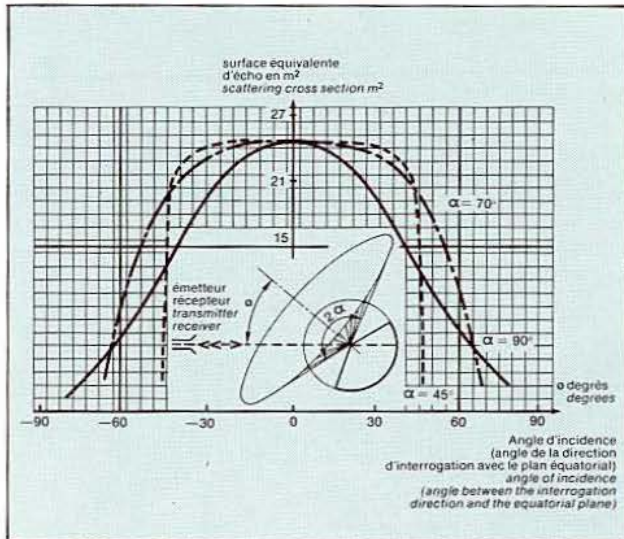

réponses types à 9375 MHz d'un réflecteur monostatique (D 6342) et d'un réflecteur bistatique (D 6357) - secteur d'espace couvert = cône $\pm 70^\circ$

typical responses at 9375 MHz of
- a monostatic reflector D 6342 - a bistatic reflector D 6357 - zone of covered space = cone $\pm 70^\circ$

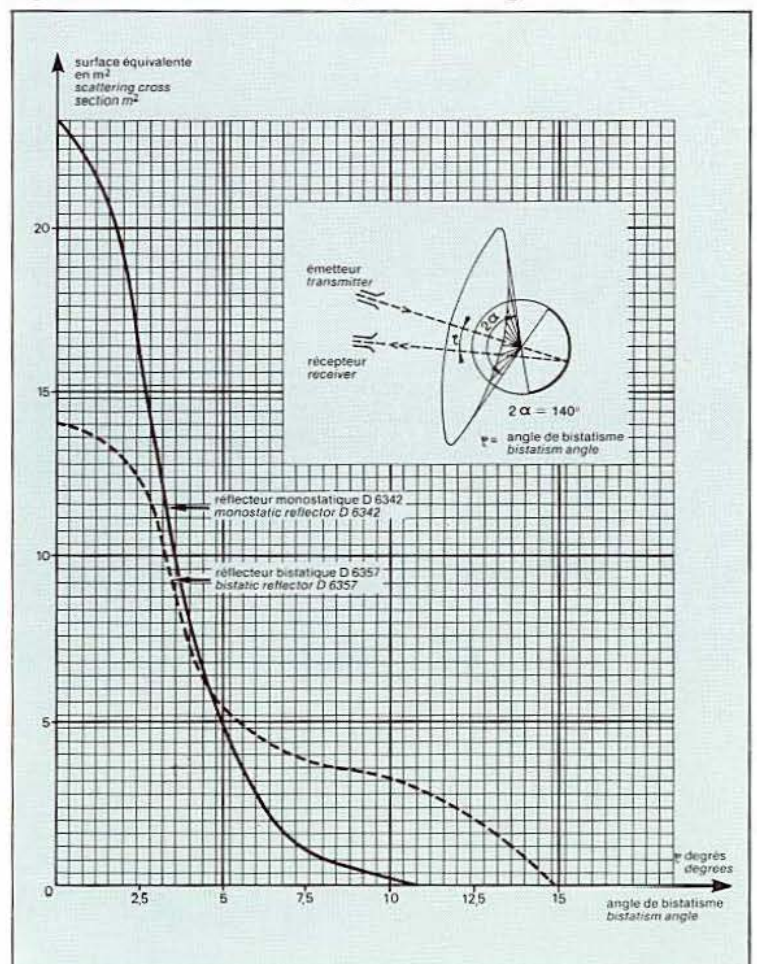

réponse type d'un réflecteur monostatique "à ceinture" (D 6351) à 9375 MHz

typical response of a belt type monostatic reflector (D 6351) at 9375 MHz

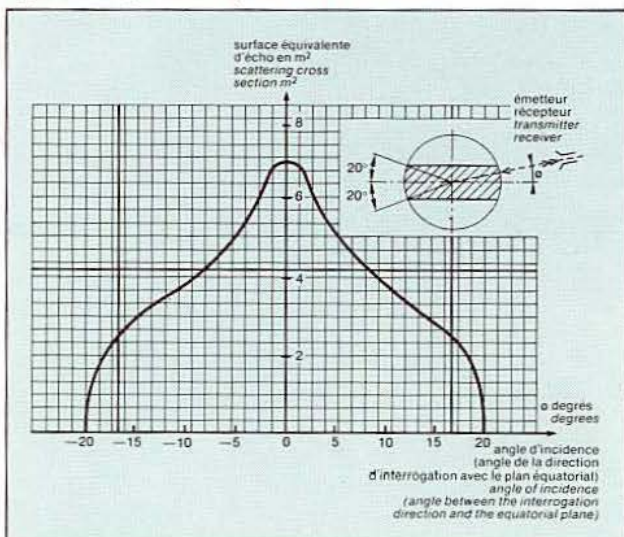

compléments techniques design aid

références internationales des guides rectangulaires standards standard rectangular waveguide international designations

BANDE DE FRÉQUENCE (MODE TE ₀₁) FREQUENCY RANGE (TE ₀₁ MODE) GHz	DIMENSIONS DES GUIDES WAVEGUIDE SIZE						NORME : MIL - W - 85 (USA) NORM :				NORME : OTAN NORM : NATO		
	DIMENSIONS EXTERIEURES OUTER DIMENSIONS mm		DIMENSIONS INTERIEURES INNER DIMENSIONS mm		TOLERANCES TOLERANCES ± mm	ÉPAISSEURS PARDI WALL THICKNESS mm	RÉFÉRENCE : DESIGNATION : M-85-()				RÉFÉRENCE : DESIGNATION : NGW-()		
	LARGEUR WIDTH (a)	HAUTEUR HEIGHT (b)	LARGEUR WIDTH (a)	HAUTEUR HEIGHT (b)			Ag	Cu	LAITON OU (Cu + Ag)* BRASS OR (Cu + Ag)*	ALLIAGE D'ALUMINIUM ALUMINIUM ALLOY 1100 6061 6063	Al	Ag	LAITON BRASS
1	0.320 - 0.490	593.8	301.7	584.2	292.1				1-001 1-002 1-161				
2	0.340 - 0.535	543.00	276.3	533.4	266.7				1-003 1-004 1-162				
3	0.410 - 0.620	463.6	235.00	457.2	228.6				1-005 1-006 1-163	1 - A01			
4	0.490 - 0.750	387.6	196.9	381.00	190.5				1-007 1-008 1-164	1 - A02			
5	0.640 - 0.975	298.5	152.4	292.1	146.05				1-009 1-010 1-165	1 - A03			
6	0.755 - 1.150	254.00	130.2	247.65	123.82				1-011 1-012 1-166	1 - A04			
7	0.960 - 1.46	195.6	97.8	195.58	97.79				1-013 1-014 1-167	1 - A05			
8	1.13 - 1.73	169.2	86.6	165.10	82.55	0.33		1-015 1-017	1-018 1-019 1-168	1 - A06		3 A06	
9	1.45 - 2.20	133.6	68.8	129.54	64.77	0.26		1-021 1-023	1-025 1-026 1-169				
10	1.72 - 2.61	113.3	58.7	109.22	54.61	0.22		1-027 1-031	1-029 1-030 1-170	1 - A08		3 A08	
11	2.12 - 3.20			88.9	44.45	0.17							
12	2.17 - 3.30	90.42	47.24	86.36	43.18	0.17		1-033 1-037	1-035 1-036 1-171	1 - A09		3 A09	
13	2.60 - 3.95	76.20	38.10	72.14	34.04	0.14		1-039 1-043	1-041 1-042 1-172	1 A10		3 A10	
14	3.22 - 4.90	61.42	32.33	58.17	29.08	0.12		1-045 1-049	1-047 1-048 1-173				
15	3.95 - 6.00	50.80	25.40	47.55	22.15	0.095		1-051 1-055	1-053 1-054 1-174	1 - A12		3 A12	
16	4.65 - 7.05	43.64	23.44	40.39	20.19	0.081		1-057 1-061	1-059 1-060 1-175				
17	5.4 - 8.2	38.10	19.05	34.85	15.80	0.070		1-063 1-067	1-065 1-066 1-176	1 - A14		3 A14	
18	6.55 - 10.0	31.75	15.88	28.50	12.62	0.06		1-069 1-073	1-071 1-072 1-177	1 - A15		3 A15	
19	8.2 - 12.5	25.40	12.70	22.86	10.16	0.05		1-075 1-079	1-077 1-078 1-178	1 - A16		3 A16	
20	9.8 - 15.0	21.59	12.06	19.05	9.52	0.04		1-081 1-085	1-083 1-084 1-179				
21	11.9 - 18.0	17.83	9.93	15.80	7.90	0.03		1-093 1-087	1-089 1-090 1-091 1-180	1 - A18	6 - A18	3 A18	
22	14.5 - 22.0	14.99	8.51	12.95	6.48	0.026		1-094 1-096	1-097 1-098 1-181				
23	18.0 - 26.5	12.70	6.35	10.67	4.32	0.022		1-106 1-100	1-102 1-103 1-104 1-182	1 - A20	6 - A20	3 A20	
24	22.0 - 35.0	10.67	6.35	8.64	4.32	0.020		1-113 1-107	1-109 1-110 1-111 1-183				
25	26.5 - 40.0	9.14	5.59	7.11	3.56	0.020		3-006 3-007	3-008* 3-009			6 - A22	
26	33.0 - 50.0	7.72	4.88	5.69	2.845	0.020		3-010 3-012	3-013* 3-013			6 - A23	
27	40.0 - 60.0	6.81	4.42	4.78	2.39	0.020		3-014 3 - 015	3-016*				
28	50.0 - 75.0	5.79	3.91	3.79	1.88	0.020		3-017 3-018	3-019*			6 - A25	
29	60.0 - 90.0	5.13	3.58	3.10	1.55	0.015		3-020 3-021	3-022*			6 - A26	
30	75.0 - 110.0	4.57	3.30	2.54	1.27	0.010		3-023 3-024	3-025*				
31	90.0 - 140.0	3.56	2.54	2.032	1.016	0.008		3-026 3-027	3-028*				
32	110.0 - 170.0	3.175	2.35	1.651	0.826	0.0064		3-029 3-030	3-031*				
33	140.0 - 220.0	2.819	2.172	1.296	0.648	0.0064		3-032 3-033	3-034*				
34	170.0 - 260.0	2.616	2.070	1.092	0.546	0.0051		3-035 3-036	3-037*				
35	220.0 - 325.0	2.388	1.956	0.864	0.432	0.0051		3-038 3-039	3-040*				
GUIDES SPÉCIAUX SPECIAL WAVEGUIDES													
36	2.85 - 4.3			66.37	29.4		2						
37	3.3 - 5.0			57.0	25.33		2						
38	6.4 - 9.8			29.16	16.21		1.63	1-156 1-155	1-157 1-158 1-160				

(1) A = ALUMINIUM C = CUIVRE S = ARGENT
A = ALUMINIUM C = COPPER S = SILVER

(2) Durée d'impulsion : 1 µs - Tension de claquage (air sec) : 15 KV/cm - P = 1 Bar
Pulse length : 1 µs - Breakdown strength (dry air) : 15 KV/cm - P = 1 Bar

NORME : UK NORM :		NORME : JAN (USA) NORM :		NORME : EIA (USA) NORM :		NORME OFFICIELLE C.E.I. I.E.C. OFFICIAL NORM				GUIDE EN CUIVRE COPPER GUIDE ($\Delta T = 110^\circ C$) PUISSANCE MOYENNE MAX.					
RÉFÉRENCE : DESIGNATION :		RÉFÉRENCE : DESIGNATION :		RÉFÉRENCE : DESIGNATION :		RÉFÉRENCE OFFICIELLE : OFFICIAL DESIGNATION :		FRÉQUENCE DE COUPURE DU MODE TE ₁₀ TE ₁₀ MODE CUT-OFF FREQUENCY		PUISSANCE (P) CRÊTE THÉORIQUE A : A : THEORETICAL MAX. PEAK POWER AT : AT :					
WG-()		RG-()/U		WR-()		R-()		dB/100 m		MW					
		Ag LAITON AI BRASS * Cu-Ag ** Cu						GHz		1.25 f _{c10} 1.9 f _{c10}					
										1.25 f _{c10} 1.9 f _{c10}					
										1.25 f _{c10} 1.9 f _{c10}					
1	00		290	2300		3		0.256	0.164	0.099	A	153	212	5900	8500
2	0		291	2100		4		0.281	0.173	0.109	A	120	173	4500	6800
3	1		201	1800		5		0.328	0.180	0.122	A	93.4	132	3200	4900
4	2		202	1500		6		0.393	0.220	0.160	A	67.6	93.3	2100	3100
5	3		203	1150		8		0.513	0.336	0.240	A	35	53.8	1150	1700
6	4		204	975		9		0.605	0.440	0.305	A	27	38.5	760	1200
7	5		205	770		12		0.766	0.635	0.436	A	17.2	24.1	450	700
8	6	69	103	650		14		0.908	0.88	0.58	A	11.8	17.1	300	480
9	7	337	338	510		18		1.157	1.23	0.84	A	7.5	10.6	180	270
10	8	104	105	430		22		1.373	1.63	1.08	A	5.2	7.5	115	190
11	9							1.686							
12	9A	112	113	340		26		1.737	2.21	1.54	A	3.4	4.7	72	110
13	10	48	75	284		32		2.078	2.40	1.64	C	2.18	3.1	45	67
14	11 A	340	341	229		40		2.579	3.92	2.78	A	1.56	2.14	30	46
15	12	49	95	187		48		3.155	5.78	4.00	A	0.94	1.32	18	24
16	13	343	344	159		58		3.714	6.62	5.00	A	0.754	0.983	12	19
17	14	50	106	137		70		4.285	8.19	6.47	A	0.554	0.696	8	12
18	15	51	68	112		84		5.260	11.5	8.91	A	0.355	0.454	5.1	7.6
19	16	52	67	90		100		6.560	17.9	12.4	A	0.206	0.296	3.2	4.5
20	17	346	347	75		120		7.873	21.2	14.8	A	0.166	0.229	2.4	3.4
21	18	107	91	349	62	140		9.490	26.7	19.6	A	0.119	0.157	1.6	2.2
22	19	353	** 352	351	51	180		11.578	36.5	26.4	A	0.079	0.106	1.00	1.4
23	20	66	53	121	42	220		14.080	57.1	42	A	0.043	0.058	0.53	0.8
24	21	*	357		34	260		17.368	53	36.8	S	0.034	0.047	0.4	0.6
25	22	96	* 271		28	320		21.100	72	49.2	S	0.023	0.032	0.28	0.4
26	23	97	** 272		22	400		26.350	101	68	S	0.014	0.020	0.17	0.26
27	24	*	358		19	500		31.410	127	89	S	0.010	0.014	0.14	0.20
28	25	98	* 273		15	620		39.900	188	128	S	0.0063	0.0090		
29	26	99	* 274		12	740		48.400	257	172	S	0.0042	0.0060		
30	27	*	359		10	900		59.050	330	232	S	0.0028	0.0040		
31	28	138	* 278		8	1200		73.840	500	325	S	0.0018	0.0026		
32	29	136	* 276		7	1400		90.485	715	449	S	0.0012	0.0017		
33	30	135	* 275		5	1800		115.75	1010	633	S	0.00071	0.00107		
34	31	137	* 277		4	2200		137.52	1260	833	S	0.00052	0.00075		
35	32	139		3	2600			173.29	1680	1140	S	0.00035	0.00047		
36				CNET 7		35		2.260							
37				CNET 6		41		2.630							
38		320		WR 102				5.142	14.9	9.34	A				

compléments techniques design aid

références internationales des brides flanges international designations

BRIDES FLANGES											GUIDES D'ONDE WAVEGUIDES		BRIDES RONDES A BROCHES CIRCULAR PIN FLANGES									
REFERENCE OFFICIELLE : NORME CEI OFFICIAL DESIGNATIONS : IEC NORM											NORME : EIA NORM : EIA	NORME : CEI NORM : IEC	NORME : JAN NORM : JAN	NORME : MIL 3922 NORM : MIL 3922								
<table border="1"> <tr> <th>BRIDE FLANGE</th> <th>GUIDE WAVEGUIDE</th> </tr> <tr> <td>C (1) A B C D E F</td> <td>R - ()</td> </tr> <tr> <td>IEC - P (2)</td> <td></td> </tr> <tr> <td>U (3)</td> <td></td> </tr> </table>											BRIDE FLANGE	GUIDE WAVEGUIDE	C (1) A B C D E F	R - ()	IEC - P (2)		U (3)		WR-()	R-()	LAITON BRASS	
BRIDE FLANGE	GUIDE WAVEGUIDE																					
C (1) A B C D E F	R - ()																					
IEC - P (2)																						
U (3)																						
CA-R()	CB-R()	PA-R()	PB-R()	PC-R()	PD-R()	PF-R()	UA-R()	UB-R()	UD-R()	UE-R()												
1					X				X		2300	3										
2					X				X		2100	4										
3					X				X		1800	5										
4					X				X		1500	6										
5					X				X		1150	8										
6					X				X		975	9										
7					X				X		770	12										
8					X				X		650	14										
9					X				X		510	18										
10					X				X		430	22										
11					X				X		340	26										
12	X		X		X		X		X	X	284	32										
13					X				X	X	229	40										
14	X		X		X		X		X	X	187	48										
15	X		X		X		X		X	X	159	58										
16	X		X		X		X		X	X	137	70										
17		X		X	X			X	X	X	112	84										
18		X		X	X			X	X	X	90	100										
19			X		X			X	X		75	120										
20		X		X	X			X	X		62	140										
21					X				X		51	180										
22		X		X	X			X			42	220										
23					X						34	260										
24		X		X	X			X			28	320	381	67B005								
25					X						22	400	383	67B006								
26					X						19	500	383 N	67B007								
27						X					15	620	385	67B008								
28						X					12	740	387	67B009								
29						X					10	900	387 M	67B010								
30						X					8	1200	387 M	74 - 001								
31											7	1400	387 M	74 - 002								
32											5	1800	387 M	74 - 003								
33											4	2200										
34											3	2600										
35								UH-R														
36								X						35								
37								X						41								

(1) Pressurisable + "piège"
Pressurizable + "choke flange"

(2) Pressurisable
Pressurizable

(3) non pressurisable
no pressurizable

EQUIVALENCES :
EQUIVALENCES : CPR()-G ≈ PD-R() CPR()-F ≈ UD-R()

BRIDES FLANGES												
NORME JAN NORM : JAN UG-()/U										NORME : EIA NORM : EIA CPR-()	NORME : EIA NORM : EIA CMR-()	
"NORMALE" "STANDARD"								"A PIEGE" "CHOKE FLANGE"		F : lisse flat G : à gorge groove	F : lisse flat	
LAIION BRASS				ALLIAGE D'ALUMINIUM ALUMINIUM ALLOY				LAIION BRASS	ALLIAGE D'ALUMINIUM ALUMINIUM ALLOY			
"FLAT"	≈CMR	≈CPR-F	≈CPR-G	"FLAT"	≈CMR	≈CPR-F	≈CPR-G					
1										2300		
2										2100		
3										1800		
4										1500		
5										1150		
6										975		
7										770		
8	417 B		1714	1362	418 B		1720	1343		650		
9			1715	1718			1717	1719		510		
10	435 A B		1716	1344	437 A		1711	1345		430		
11	553 A		1712	1346	554 A		1713	1347		340		
12	53	1479	1724	1348	584	1484	1725	1349	54 A B	585 A	284	284
13			1726	1350			1727	1351			229	229
14	149 A	1475	1728	1352	407	1480	1729	1353	148 B C	406 A R	187	187
15			1730	1354			1731	1355			159	159
16	344	1476	1732	1356	441	1481	1733	1357	343 A B	440 A B	137	137
17	51	1477	1734	1358	138	1482	1735	1359	52 A B	137 A	112	112
18	39	1478	1736	1360	135	1483	1737	1361	40 A	136 A	90	90
19												
20	419				1665				541 A	1666		
21												
22	595				597				596 A	598 A		
23												
24	599								600 A B			
25	599 N	1521										
26	599 N											
27	599 M	1523										
28	599 M	1522										
29												
30												
31												
32												
33												
34												
35												
36												
37												

La plupart des brides IEC ont une bride équivalente EIA ou JAN.
Most IEC flanges have equivalent flanges within EIA or JAN standard.

X normalisation existante
norms available

boîtiers case outlines

unités: mm
units: mm

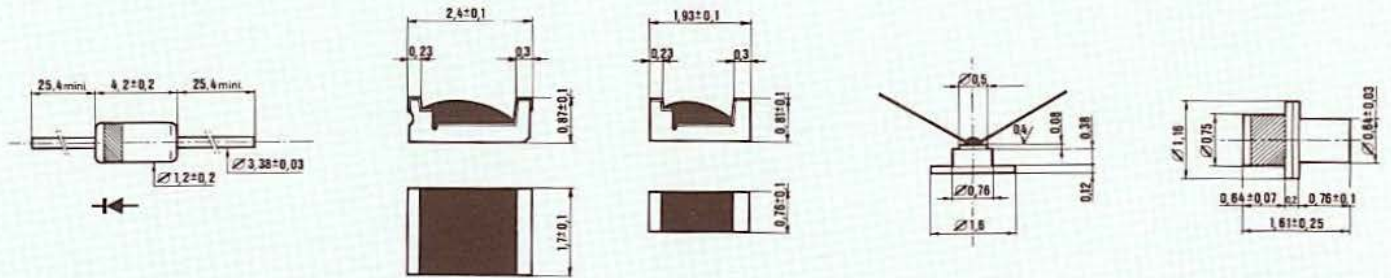

A 22 e

BH 1

BH 4

BH 5

BH 10

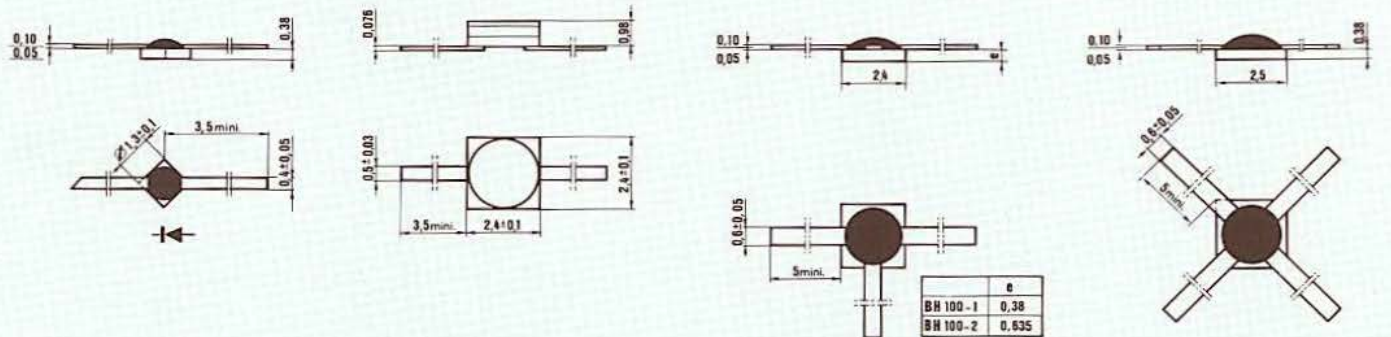

BH 15

BH 16

BH 100

BH 101

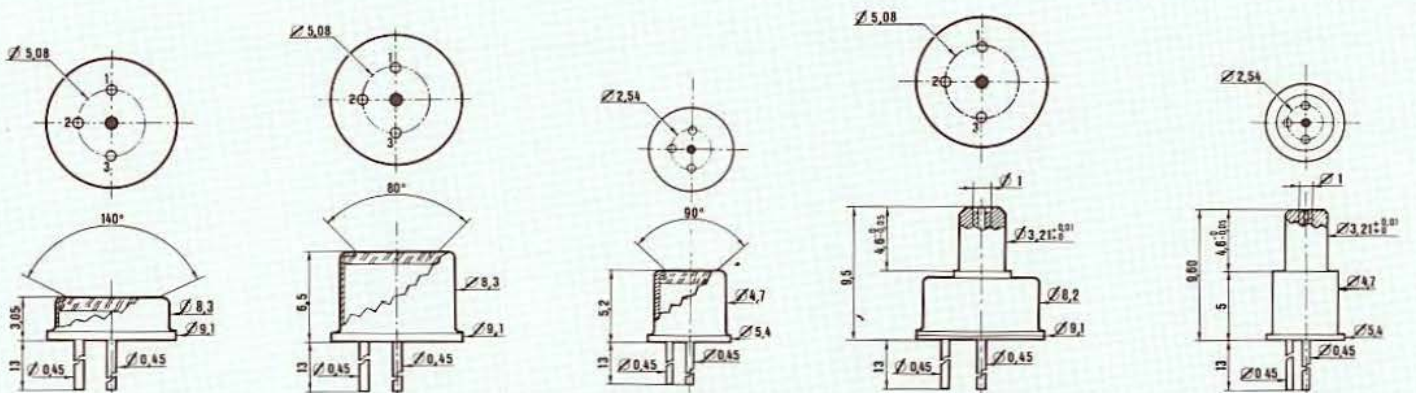

BH 104 a

BH 104 b

BH 105 a

BH 106 a-b-c

BH 107 a-b-c

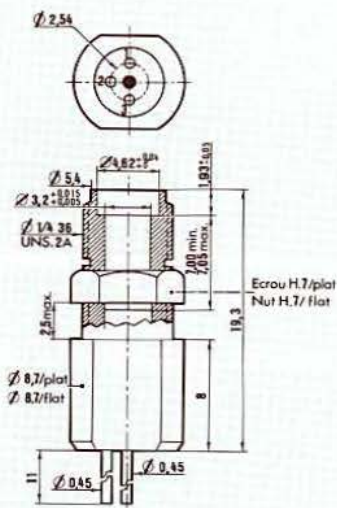

BH 108 a-b-c

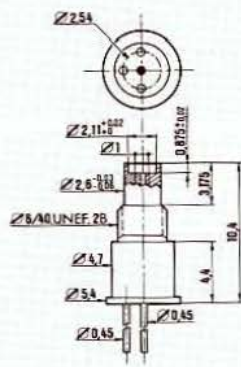

BH 109 a-b-c

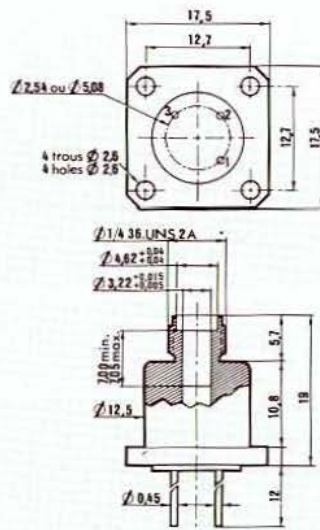

BH 110 a-b-c

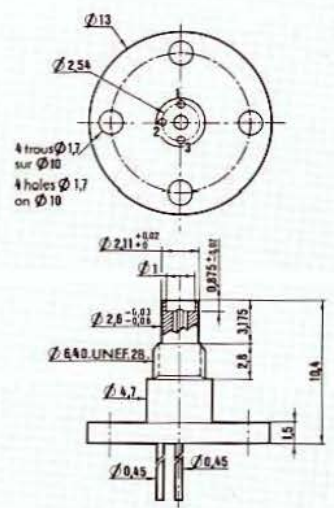

BH 111 a-b-c

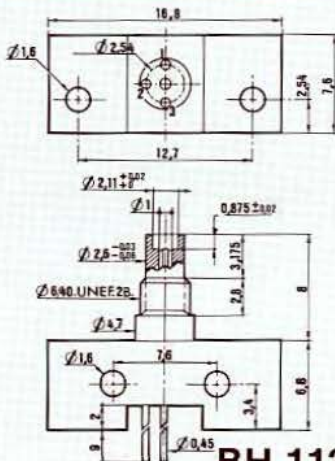

BH 112 a-b-c

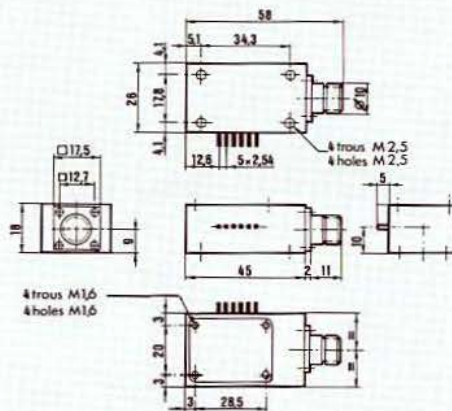

BH 120 (BH 121 : "PIG-TAIL")

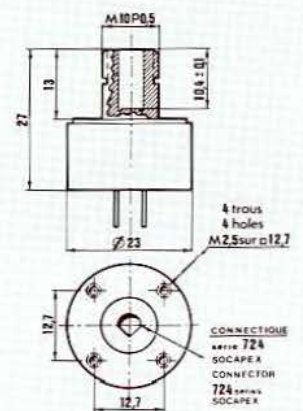

BH 123

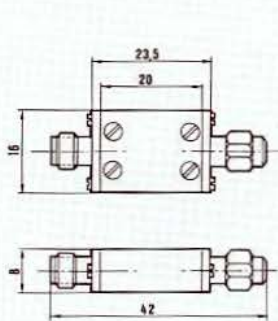

BMH 2

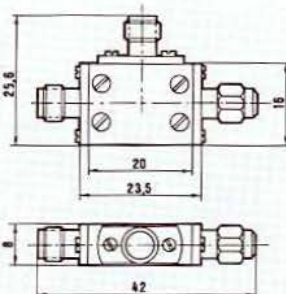

BMH 3

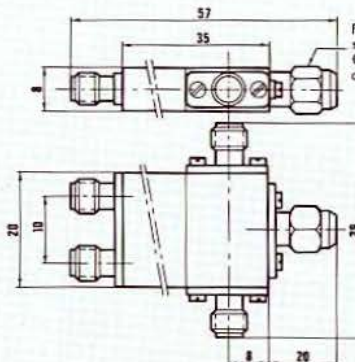

BMH 5

Fiche femelle RIM
sur demande
OSM female
connector on request

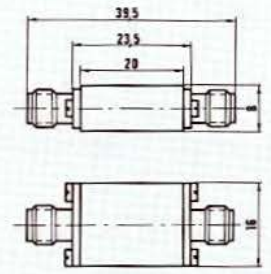

BMH 7

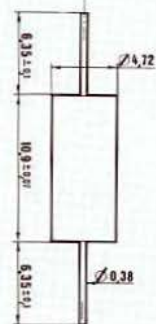

BMH 11

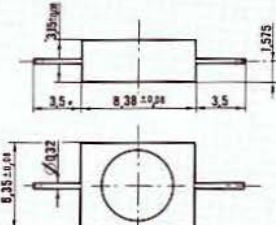

BMH 16

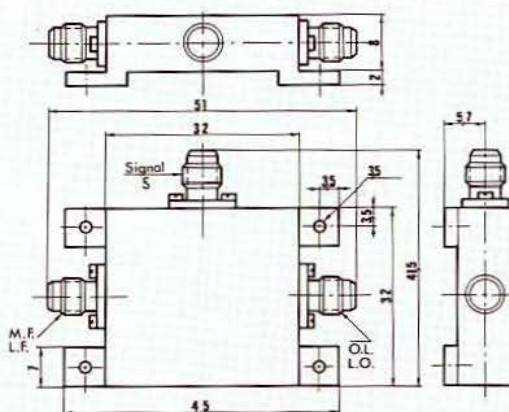

BMH 35 B

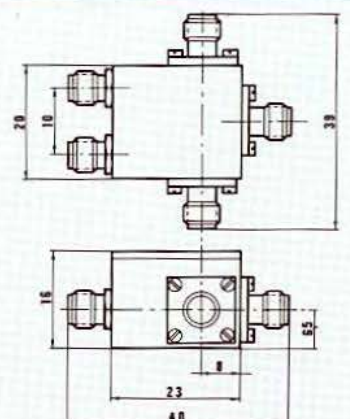

BMH 59

boîtiers case outlines

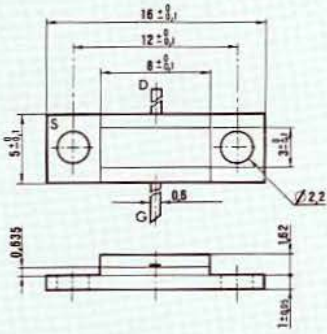

BMH 60

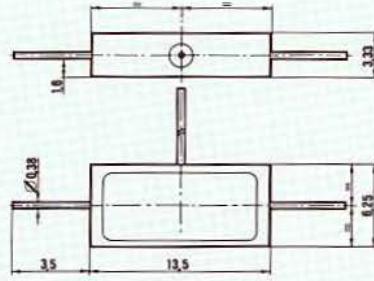

BMH 73

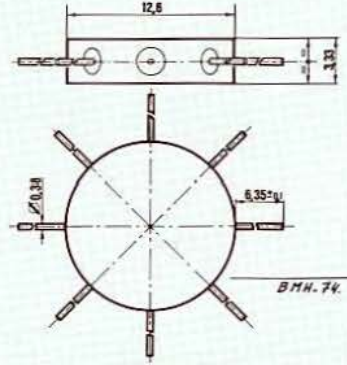

BMH 74

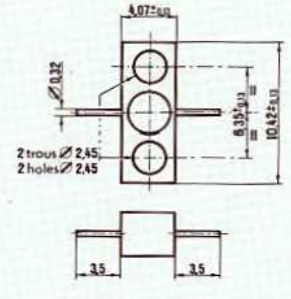

BMH 76

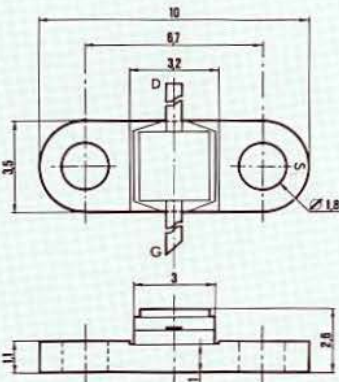

BMH 77 P

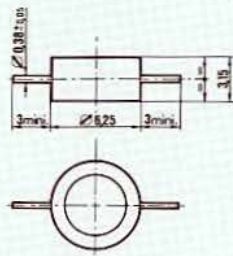

BMH 78

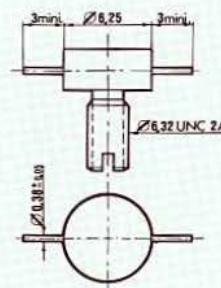

BMH 78 a

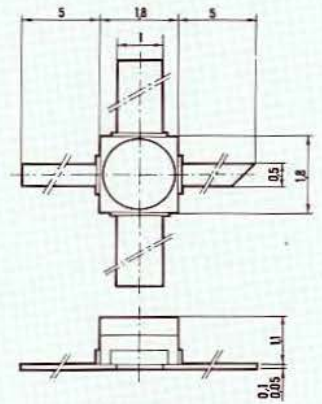

BMH 83

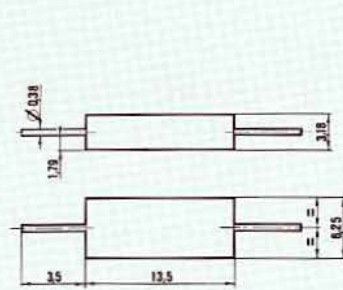

BMH 85

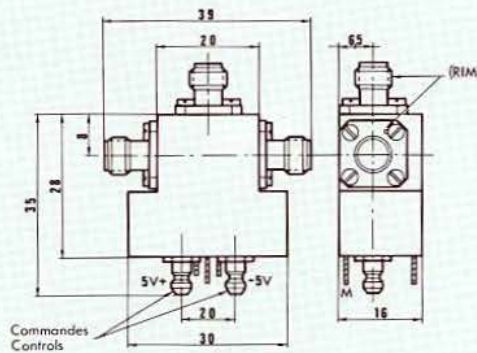

BMH 105

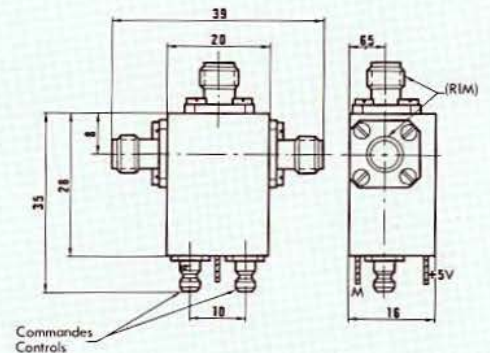

BMH 106

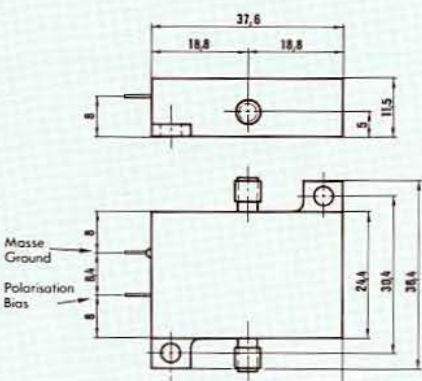

BMH 107

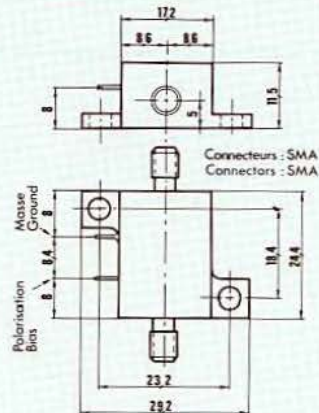

BMH 108

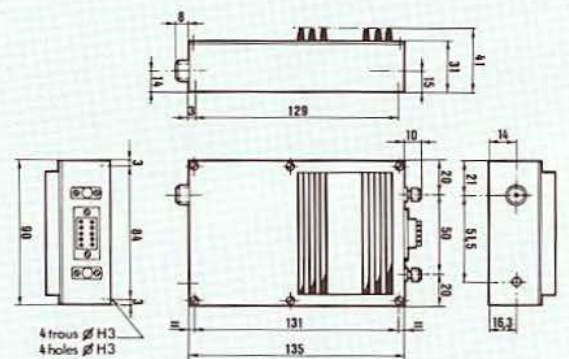

BMH 120 (BMH 121 : "PIG-TAIL")

boîtiers case outlines

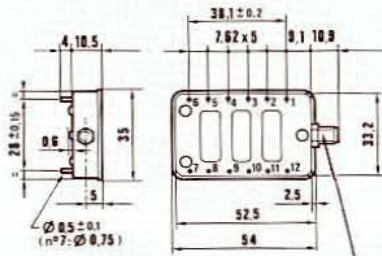

connecteur optique
type SMA-SYCEP
(1/4 36UNS 2A)
optical connector
type SMA-SYCEP
(1/4 36UNS 2A)

BMH 125

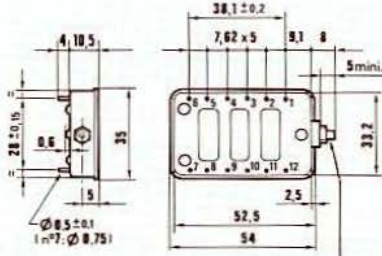

connecteur optique
Socapex 7201
optical connector
Socapex 7201

BMH 126

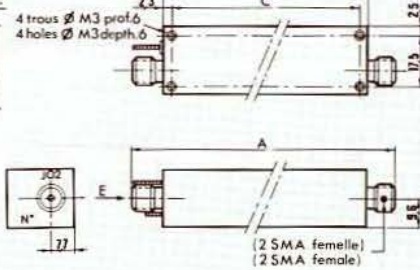

	A	B	C
BMH 132	71	57	52.4
BMH 133	86	72	67.4
BMH 134	101	87	82.4
BMH 135	116	102	97.4
BMH 136	131	117	112.4
BMH 137	146	132	127.4
BMH 149	155	141	136.4

BMH 132 → 137

BMH 149

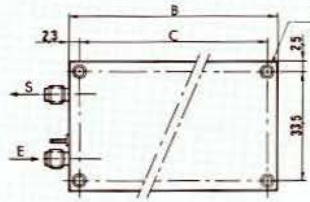
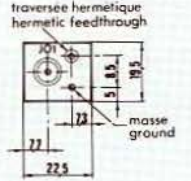

	A	B	C
BMH 138	69	62	57.4
BMH 139	84	77	72.4
BMH 140	99	92	87.4

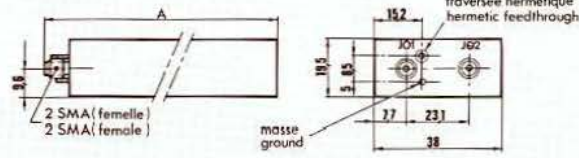

BMH 138 → 140

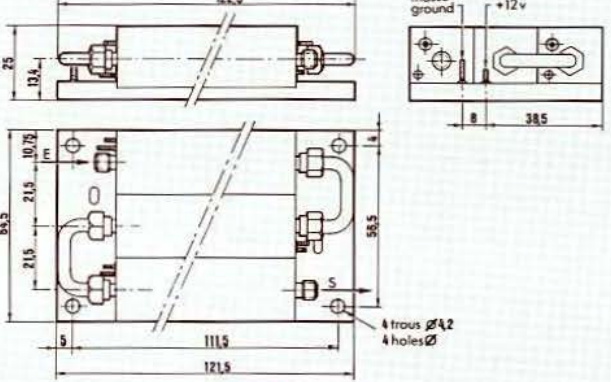

BMH 145

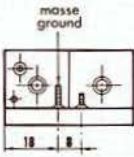
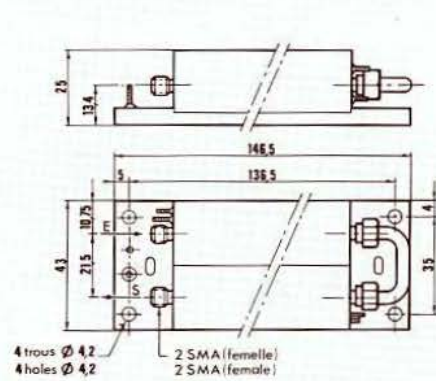

BMH 146

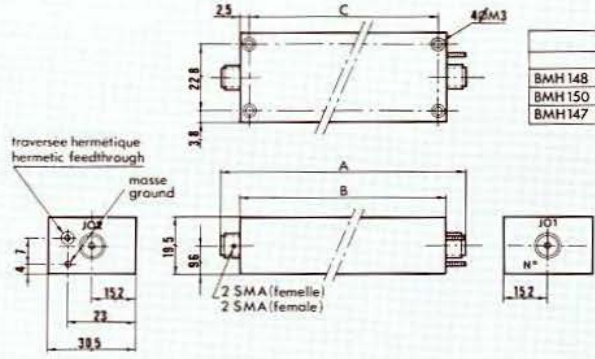

	A	B	C
BMH 148	99.6	87.6	82.6
BMH 150	114.6	102.6	97.6
BMH 147	129.6	117.6	112.6

BMH 147 BMH 148

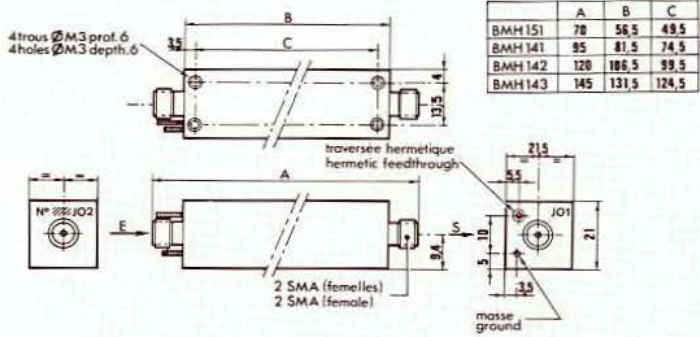

	A	B	C
BMH 141	70	56.5	49.5
BMH 142	85	71.5	64.5
BMH 143	100	86.5	79.5
BMH 144	115	101.5	94.5

BMH 141 → 143 BMH 151

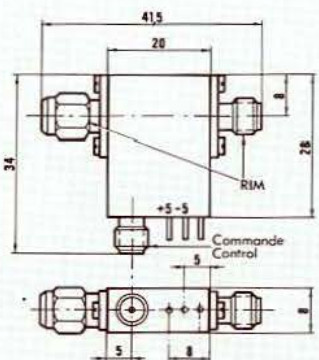

BMH 152

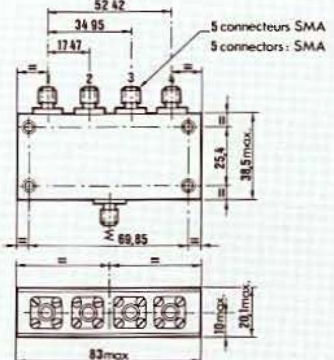

BMH 153

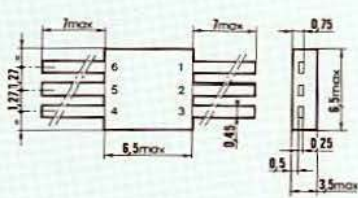

BMH 154

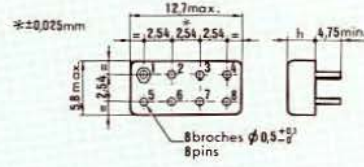

BMH 155	BMH 156
h 6.4 mm	10.4 mm

BMH 155 - 156

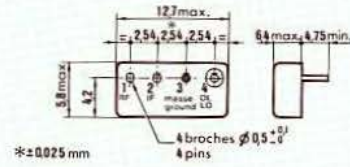

BMH 157

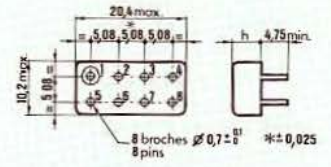

BMH 158	BMH 159
h 5.3 max	10.4 max

BMH 158 - 159

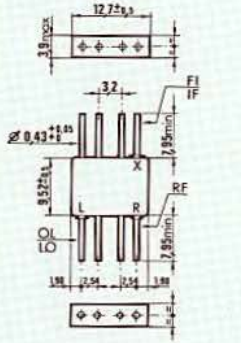

BMH 160

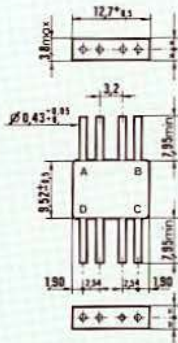

BMH 161

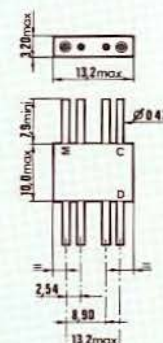

BMH 162

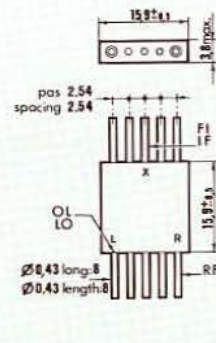

BMH 163

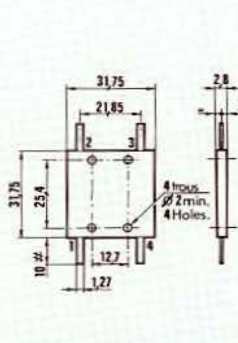

BMH 164

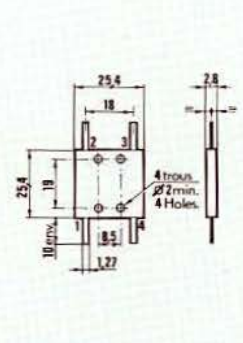

BMH 165

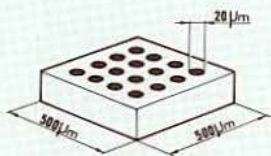

C 1

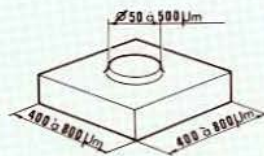

C 2

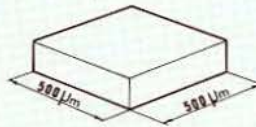

C 4

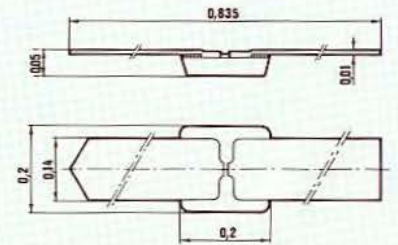

C 100

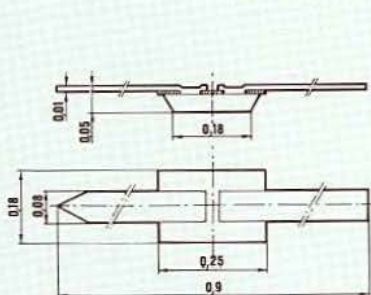

C 101

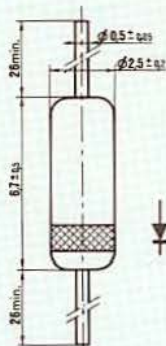

DO 7



E 1

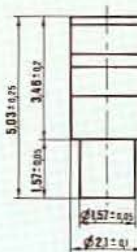

E 1 P

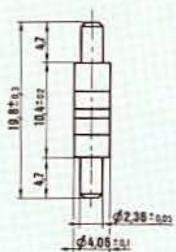

E 2



E 2 P

boîtiers case outlines

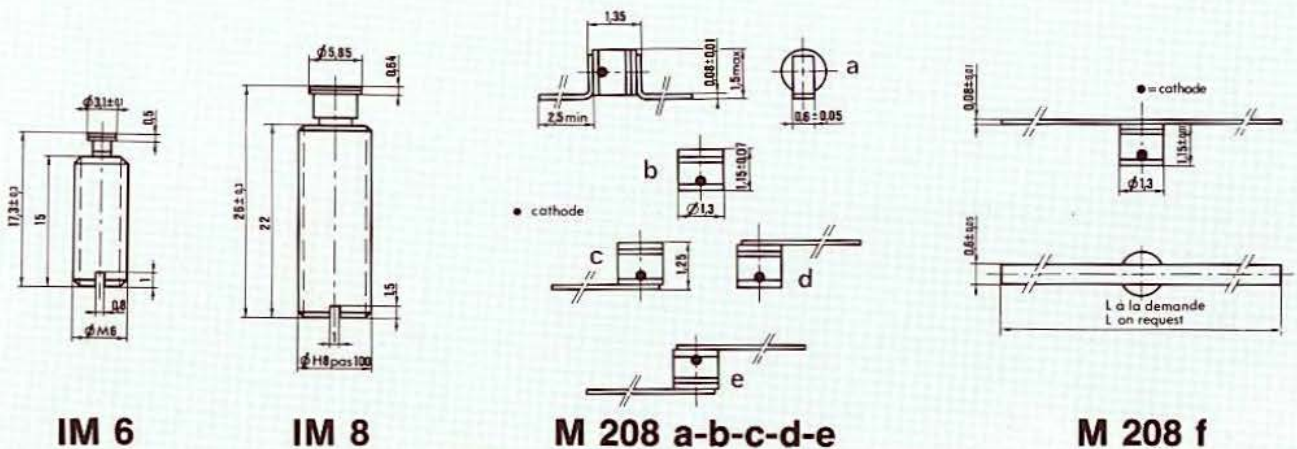
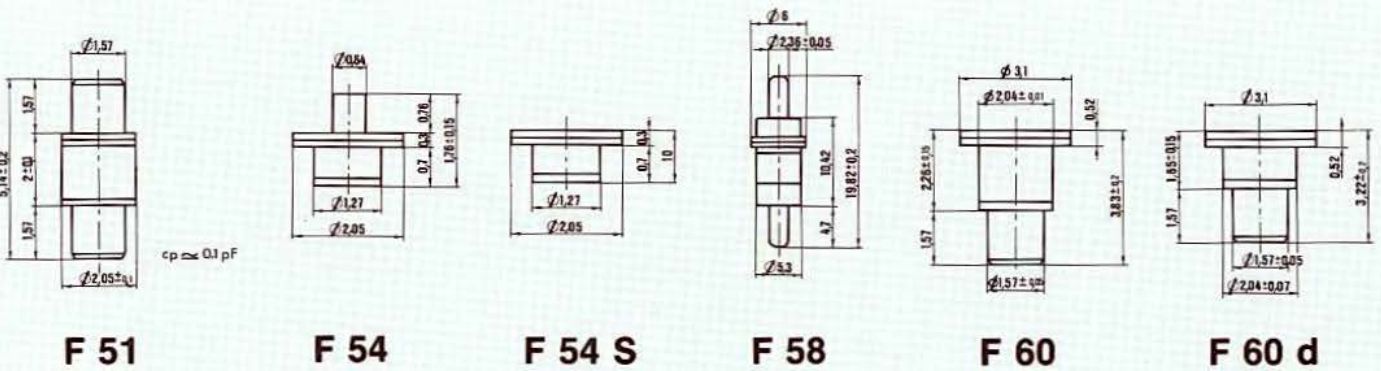
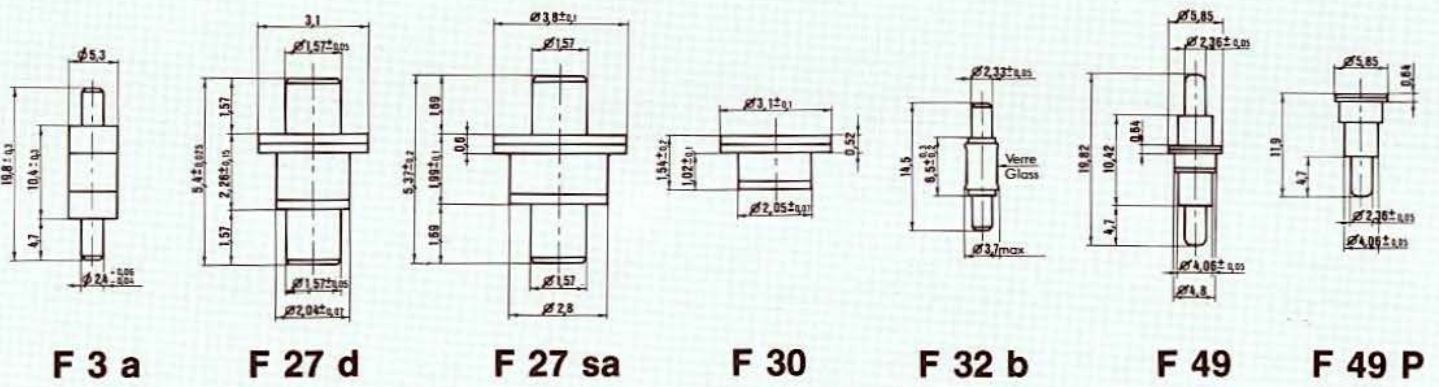
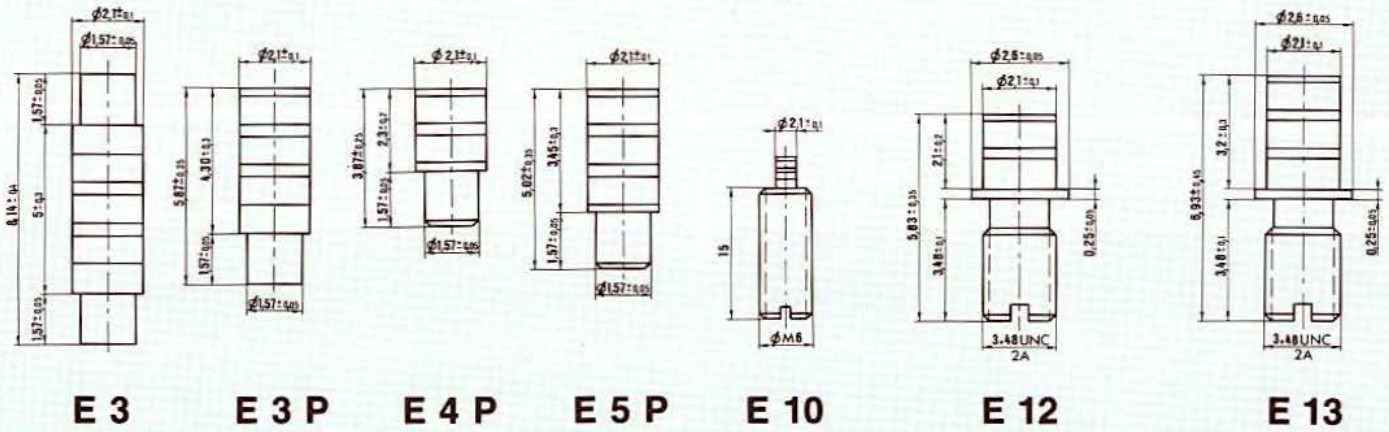

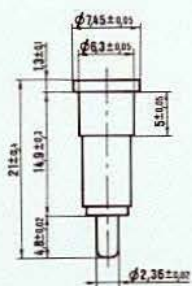

P 3

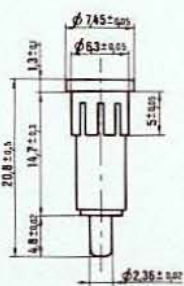

P 3 a

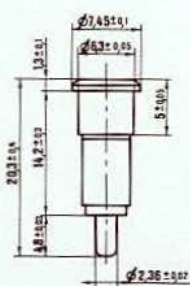

P 3 c

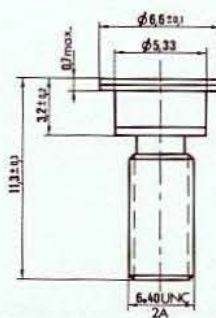

S 358

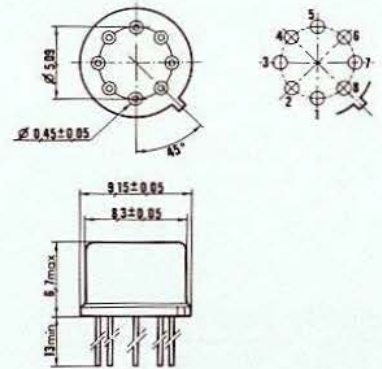

TO 5

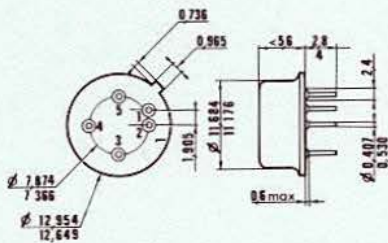

TO 8 - 125

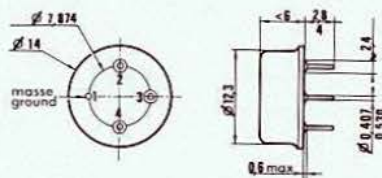

TO 8 - 144

■ broches
■ pins

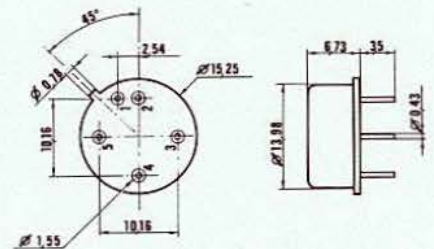

TO 8 - 155

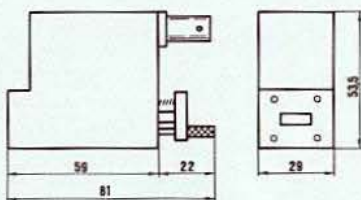

TH 5115

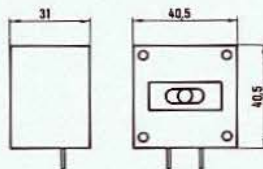

TH 5118

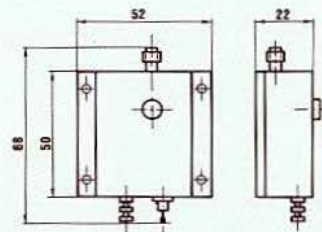

TH 5129

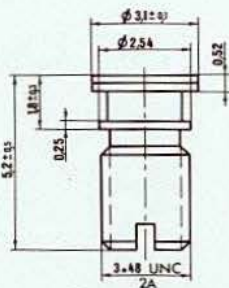

W 1 (S 268)

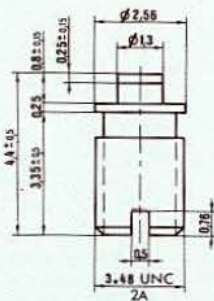

W 2

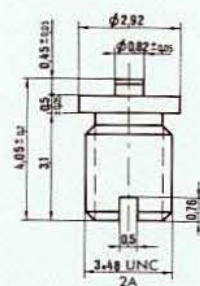

W 3

boîtiers case outlines

lignes à retard delay lines

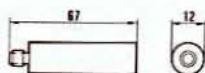
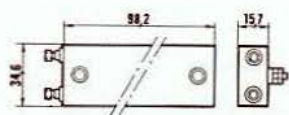

A



	a	b
C2	153*	16
C3	182	16,5
C4	238	19,5
C5	114	19,5
C6	159	19,5
C7	191*	16
C8	129	16
C9	225	16

*un connecteur
one connector

C

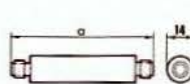

	a
D1	82
D2	105
D3	159
D4	72

D

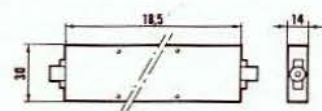

E

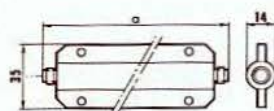

	a
F1	120
F2	114

F

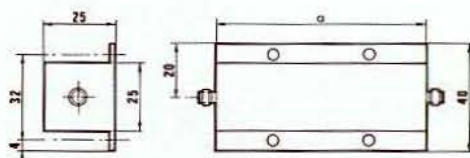

	a
G1	66
G2	70
G3	78
G4	83
G5	55
G6	80

G

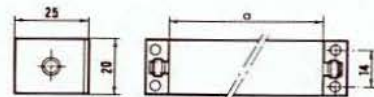

	a
H1	59
H2	74
H3	83

H

index

TYPE	PAGE	TYPE	PAGE	TYPE	PAGE	TYPE	PAGE	TYPE	PAGE
1N 21 C	17	AH 164	14	AH 451	20	AR 1001	71	AR 2902	59
1N 21 CR	17	AH 165	14	AH 452	20	AR 1002 A	72	AR 2908 C	63
1N 21 D	17	AH 166	14	AH 453	20	AR 1003 A	72	AR 2909	60
1N 21 DR	17	AH 167	14	AH 454	20	AR 1004	72	AR 2915 D	60
1N 23 C	17	AH 168	14	AH 479	20	AR 1005	72	AR 2916	60
1N 23 CR	17	AH 169	14	AH 480	20	AR 1007	72	AR 2916 B	60
1N 23 D	17	AH 224 R	21	AH 481	20	AR 1008	71	AR 2920 B	58
1N 23 DR	17	AH 225 R	21	AH 482	20	AR 1009	71	AR 2921	59
1N 23 E	17	AH 259 R	21	AH 483	20	AR 1010	71	AR 2922	57
1N 23 ER	17	AH 260 R	21	AH 484	20	AR 1011	71	AR 2923	57
1N 31	17	AH 261 R	21	AH 485	20	AR 1011 A	71	AR 2925	57
1N 31 R	17	AH 262 R	21	AH 486	20	AR 1011 B	71	AR 2928	60
1N 32	17	AH 291 R	21	AH 487	20	AR 1012	71	AR 2930	60
1N 32 R	17	AH 292 R	21	AH 488	20	AR 1014	72	AR 2939	67
1N 149	17	AH 293 R	21	AH 489	20	AR 1015	72	AR 2941	66
1N 149 R	17	AH 294 R	21	AH 490	20	AR 1016	71	AR 2941 C	66
1N 415 C	17	AH 326 R	21	AH 512	21	AR 1016 A	71	AR 2941 D	66
1N 415 D	17	AH 327 R	21	AH 513	21	AR 1022 A	71	AR 2953	66
1N 415 E	17	AH 328 R	21	AH 518	21	AR 1024	71	AR 2953 A	66
1N 416 C	17	AH 329 R	21	AH 519	21	AR 1025	71	AR 2954	57
1 N 416 D	17	AH 330 R	21	AH 543	21	AR 1026	71	AR 2959	59
1N 2102	17	AH 347 R	21	AH 544	21	AR 1028	71	AR 2960	60
A 23	75	AH 348 R	21	AH 545	21	AR 2600	61	AR 2971	64
A 28	75	AH 349 R	21	AH 546	21	AR 2603	61	AR 2972	57
A 30	75	AH 350 R	21	AH 573	21	AR 2604 C	61	AR 2974 A	60
A 37	75	AH 365	20	AH 574	21	AR 2610	68	AR 2975	63
A 50	75	AH 366	20	AH 575	21	AR 2613	68	AR 2983	67
A 230	75	AH 367	20	AH 579	21	AR 2613 C	68	AR 2983 D	67
A 370	75	AH 368	20	AH 580	21	AR 2620	61	AR 2985	66
AD 6771	40	AH 369	20	AH 581	21	AR 2621	61	AR 2988	58
AD 6792	40	AH 370	20	AH 601	20	AR 2631	68	CBC 14	72
AH 106	9	AH 371	20	AH 602	20	AR 2631 A	68	CBC 15	72
AH 108	9	AH 372	20	AH 603	20	AR 2631 B	68	CBC 16	72
AH 110	9	AH 411	20	AH 604	20	AR 2637	64	CBC 54	72
AH 131	8	AH 412	20	AH 605	20	AR 2643	61	CBC 74	72
AH 132	8	AH 413	20	AH 606	20	AR 2654	61	CBC 78	72
AH 133	8	AH 414	20	AH 607	20	AR 2672	65	CBK 11	72
AH 134	8	AH 415	20	AH 608	20	AR 2850	72	CBK 21	72
AH 135	8	AH 416	20	AH 609	20	AR 2853	71	CBX 02	72
AH 141	8	AH 417	20	AH 610	20	AR 2853 B	71	CBX 10	72
AH 142	8	AH 418	20	AH 611	20	AR 1853 C	71	CBX 13	72
AH 152	14	AH 419	20	AH 612	20	AR 2853 E	71	CBX 24	72
AH 153	14	AH 443	20	AH 613	20	AR 2854	71	CBX 26	72
AH 154	14	AH 444	20	AH 614	20	AR 2868	72	D 1	74
AH 155	14	AH 445	20	AH 615	20	AR 2869	71	D 2	74
AH 156	14	AH 446	20	AH 677	21	AR 2869 A	71	D 3	74
AH 160	14	AH 447	20	AR 1000	71	AR 2876	71	D 4	74
AH 161	14	AH 448	20	AR 1000 A	71	AR 2877	71	D 5	74
AH 162	14	AH 449	20	AR 1000 B	71	AR 2879	71	D 6205 A	80
AH 163	14	AH 450	20	AR 1000 C	71	AR 2879 A	71	D 6206	80

index

TYPE	PAGE	TYPE	PAGE	TYPE	PAGE	TYPE	PAGE	TYPE	PAGE
D 6209	80	DH 245	8	DH 385	19	DH 601	9 - 15	DH 794	13
D 6210	80	DH 246	8	DH 401	11	DH 602	9 - 15	DH 795	13
D 6213	80	DH 252	8	DH 401 B	11	DH 603	9 - 15	DH 7811 A	13
D 6214	80	DH 256	8	DH 402	11	DH 604	9 - 15	DH 7812 A	13
D 6215	80	DH 267	8	DH 402 B	11	DH 605	9 - 15	DH 7813 A	13
D 6306	79	DH 270	8	DH 403	11	DH 606	9 - 15	DH 7814 A	13
D 6310 A	79	DH 286	8	DH 403 B	11	DH 622	16	DH 7815 A	13
D 6316 A	79	DH 287	8	DH 404	11	DH 623	16	DH 7816 A	13
D 6319 A	79	DH 288	8	DH 405	11	DH 624	16	DH 7817 A	13
D 6327 A	79	DH 292	8	DH 405 B	11	DH 625	16	DH 7818 A	13
D 6334	79	DH 293	8	DH 407	11	DH 631	10	DH 7819 A	13
D 6338	79	DH 294	8	DH 408	11	DH 631 B	10	DH 7820 A	13
D 6339	79	DH 301	18	DH 409	11	DH 632	10	DH 7821 A	13
D 6342	79	DH 302	18	DH 437	11	DH 632 B	10	DH 7822 A	13
D 6348	79	DH 303	18	DH 438	11	DH 633	10	DH 7823 A	13
D 6351	79	DH 309	19	DH 439	11	DH 633 B	10	DH 7824 A	13
D 6351 A	79	DH 309 D	18	DH 441	11	DH 634	10	DH 7825 A	13
D 6352	79	DH 309 E	18	DH 442	11	DH 634 B	10	DH 7826 A	13
D 6357	79	DH 309 F	18	DH 443	11	DH 635	10	DHC 31	67
D 6358	79	DH 309 G	18	DH 451	11	DH 635 B	10	DHC 32	67
D 6360	79	DH 312	18	DH 453	11	DH 636	10	DHS 32	67
D 6363	79	DH 313	18	DH 454	11	DH 637	10	DHS 331	67
D 6363 A	79	DH 314	18	DH 482	11	DH 724	14	DHX 10	67
D 6368	79	DH 315	18	DH 488	12	DH 726	14	DHX 20	67
D 6369	79	DH 319	19	DH 489	12	DH 728	14	DHX 22	67
D 6372	79	DH 319 D	18	DH 491	12	DH 730	14	DHX 23	67
D 6374	79	DH 319 E	18	DH 493	12	DH 732	14	DHX 301	67
D 6374 A	79	DH 319 F	18	DH 495	12	DH 733	14	EH 255	8 - 16
D 6375	79	DH 319 G	18	DH 496	12	DH 734	14	EH 256	8 - 16
D 6376	79	DH 319 H	18	DH 501	15	DH 735	14	EH 257	8 - 16
D 6376 A	79	DH 322	18	DH 502	15	DH 736	14	EH 258	8 - 16
D 6377	79	DH 323	18	DH 511	15	DH 737	14	EH 305	19
D 6377 A	79	DH 324	18	DH 512	15	DH 738	14	EH 315	19
D 6378	79	DH 325	18	DH 513	15	DH 740	13	EH 317	19
D 6380	79	DH 340	19	DH 514	15	DH 741	13	EH 318	19
D 6382	79	DH 351	18	DH 531	11	DH 742	13	EH 320	19
D 6392 A	79	DH 352	18	DH 531 B	11	DH 743	13	EH 404	12
DH 110	8	DH 353	18	DH 532	11	DH 744	13	EH 407	12
DH 200	8	DH 362	18	DH 532 B	11	DH 745	13	EH 408	12
DH 236	8	DH 363	18	DH 541	13	DH 746	13	EH 409	12
DH 238 G	8	DH 364	18	DH 542	13	DH 747	13	EH 412	13
DH 239 G	8	DH 365	18	DH 543	13	DH 751	9	EH 424	12
DH 240	8	DH 372	18	DH 544	13	DH 752	9	EH 426	12
DH 240 G	8	DH 373	18	DH 551	13	DH 753	9	EH 428	12
DH 241	8	DH 374	18	DH 552	13	DH 755	9	EH 429	12
DH 241 G	8	DH 375	18	DH 553	13	DH 756	9	EH 488	12
DH 242	8	DH 378	19	DH 582	11	DH 790	13	EH 491	12
DH 242 G	8	DH 379	19	DH 583	11	DH 791	13	EH 493	12
DH 243	8	DH 383	19	DH 584	11	DH 792	13	EH 496	12
DH 243 G	8	DH 384	19	DH 585	11	DH 793	13	EH 511	15

index

TYPE	PAGE	TYPE	PAGE	TYPE	PAGE	TYPE	PAGE	TYPE	PAGE
EH 512	15	F 10501	63	F 30058	61	F 30578	57	F 52201 R	69
EH 513	15	F 10502	63	F 30067	61	F 30579	57	F 52202 R	69
EH 514	15	F 10503	63	F 30068	61	F 30581	57	F 52204	69
EH 533	13	F 10511	63	F 30069	61	F 30585	59	F 52205	69
EH 624	9 - 16	F 10513	64	F 30074	62	F 30586	59	F 52205 A	69
EH 625	9 - 16	F 10521	63	F 30075	62	F 30587	60	F 53008 A	41
EH 733	15	F 10524	63	F 30076	62	F 30588	57	F 53008 B	41
EH 734	15	F 10525	63	F 30077	62	F 30590	57	F 53008 C	41
EH 735	15	F 10529	63	F 30079	62	F 30595	59	F 53008 D	41
EH 740	14	F 10535	67	F 30081	61	F 30600	57	F 54700	41
EH 741	14	F 10536	67	F 30085	61	F 30600 A	57	F 54701	41
EH 742	14	F 10537	63	F 30086	61	F 30601	59	F 54702	41
EH 790	14	F 10539	63	F 30088	62	F 30602	59	F 54704	42
EH 791	14	F 10542	63	F 30095	61	F 30603	59	F 54705	42
EH 792	14	F 10544	63	F 30100 A	61	F 30604	59	F 54706	42
F 5026	54	F 10546	63	F 30103	61	F 30605	59	F 54707	42
F 5029	54	F 10548	63	F 30104	61	F 30606	59	F 54708	42
F 5031	54	F 10550	63	F 30105	61	F 30617	59	F 54709	41
F 5037	53	F 10551	63	F 30106	61	F 30629	57	F 54710	42
F 5039	53	F 10552	63	F 30114	62	F 30643	59	F 54711	42
F 5041	54	F 10553	63	F 30115	62	F 30644	59	F 54712	42
F 5203	53	F 10554	63	F 30116	62	F 30647	59	F 54713	42
F 5205 A	53	F 10555	64	F 30117	61	F 30651	59	F 54714	42
F 5205 B	53	F 10558	63	F 30143	61	F 31800	70	F 56133	41
F 5206	54	F 10559	67	F 30144	61	F 31801	70	F 56135	41
F 5208	53	F 10562	67	F 30145	61	F 31802	70	F 56334	43
F 5209	53	F 10570	67	F 30147	61	F 31803	70	F 56335	43
F 5210	53	F 10573	66	F 30151	61	F 31804	70	F 56335 A	43
F 5404 A	53	F 10573 A	66	F 30500	60	F 31805	70	F 56336	43
F 5404 B	53	F 10576	67	F 30507	60	F 31820	70	F 56336 A	43
F 5410	54	F 10580	66	F 30511	66	F 31821	70	F 56337	43
F 5411 A	54	F 10582	66	F 30522	57	F 31822	70	F 56337 A	43
F 5414	54	F 11000	70	F 30525	66	F 31823	70	F 56338	43
F 5415	54	F 11001	70	F 30531	58	F 31824	70	F 56338 A	43
F 5417	44 - 53	F 11002	70	F 30532	66	F 31825	70	F 56341	43
F 5420	54	F 11003	70	F 30534	57	F 31830	70	F 56341 B	43
F 5421	54	F 11004 A	70	F 30536	58	F 31831	70	F 56342	43
F 5432	54	F 11005	70	F 30539	59	F 31832	70	F 56342 B	43
F 10001	65	F 30005	61	F 30543	57	F 31833	70	F 56344	43
F 10004	68	F 30006	61	F 30546	58	F 31834	70	F 56345	43
F 10007	68	F 30012	61	F 30548	60	F 31835	70	F 56346	43
F 10008	68	F 30022	62	F 30556	57	F 31840	70	F 56347 A	43
F 10056 A	65	F 30022 A	62	F 30558	57	F 31841	70	F 56358	43
F 10057	65	F 30025	61	F 30563	60	F 31842	70	F 56358 B	43
F 10057 A	65	F 30031	61	F 30567	58	F 31850	70	F 56600	40
F 10057 B	65	F 30039	61	F 30568	58	F 32205	60	F 56616	40
F 10058	65	F 30043	61	F 30569	58	F 32206	60	F 56619	40
F 10500	63	F 30046	61	F 30570	60	F 33033	41	F 56621	40
F 10500 A	63	F 30049	61	F 30576	57	F 33036	41	F 56623	40
F 10500 C	66	F 30056	61	F 30577	57	F 52200 R	69	F 56624	40

TYPE	PAGE	TYPE	PAGE	TYPE	PAGE	TYPE	PAGE	TYPE	PAGE
F 56626	40	HBC 34	60	IBC 74	64	MH 108 D	34	MH 128 RA	39
F 56627	40	HBC 60	60	IBC 75	64	MH 108 E	34	MH 128 RB	39
F 56628	40	HBC 61	60	IBC 76	64	MH 108 E	34	MH 128 RC	39
F 56630	40	HBC 141	64	IBC 87	64	MH 108 G	34	MH 128 RD	39
F 56631	40	HBC 151	64	IBC 88	64	MH 108 RA	34	MH 128 RE	39
F 56632	40	HBC 286	60	IBC 92	64	MH 108 RB	34	MH 128 RF	39
F 56633	40	HBC 287	60	IBC 93	64	MH 108 RC	34	MH 128 RG	39
F 56635	40	HBC 288	60	IBC 94	64	MH 108 RD	34	MH 141	34
F 56636	40	HBC 602	60	IBC 95	64	MH 108 RE	34	MH 141 R	34
F 56638	40	HBC 604	60	IBK 50	65	MH 108 RF	34	MH 142	34
F 56641	40	HBC 631	60	IBK 51	65	MH 108 RG	34	MH 142 R	34
F 56643	41	HBC 651	60	IBK 55	65	MH 109 A	34	MH 143	34
F 56643 A	41	HBK 10	64	IBK 56	65	MH 109 B	34	MH 243 R	34
F 56650	40	HBK 11	64	IBK 65	65	MH 109 C	34	MH 144	34
F 56651	40	HBK 12	64	IBK 70	65	MH 109 D	34	MH 144 R	34
F 56655	40	HBK 21	64	IBK 591	65	MH 109 E	34	MH 145	34
F 56657	40	HBK 40	60	IBK 592	65	MH 109 F	34	MH 145 R	34
F 56658	40	HBK 41	60	IBM 60	65	MH 109 G	34	MH 146	34
F 56660	40	HBK 401	60	IBQ 71	65	MH 109 RA	34	MH 146 R	34
F 56662	40	HBL 04	60	IBX 10	64	MH 109 RB	34	MH 147	34
F 56663	40	HBL 10	60	IBX 11	64	MH 109 RC	34	MH 147 R	34
F 57101	44	HBL 11	60	IBX 12	64	MH 109 RD	34	MH 151	12
F 57102	44	HBL 12	60	IBX 13	64	MH 109 RE	34	MH 153	12
F 57104	44	HBL 54	60	IBX 20	64	MH 109 RF	34	MH 162	37
F 57510	43	HBS 30	60	IBX 50	65	MH 109 RG	34	MH 163	37
F 57511	43	HBS 601	60	IBX 55	65	MH 110	34	MH 164	37
F 57512	43	HBS 602	60	IBX 60	65	MH 110 R	34	MH 165	37
F 57515 A	43	HBS 603	60	IHC 30	68	MH 111	34	MH 168	37
F 57516	43	HBS 604	60	IHS 60	68	MH 111 R	34	MH 169	37
F 57517	43	HBU 110	60	IHX 28	68	MH 115	34	MH 170	37
F 57518	43	HBU 111	60	IHX 30	68	MH 115 R	34	MH 171	37
F 57520	43	HBX 01	64	IHX 32	68	MH 116	34	MH 192 A	36
F 57523 A	43	HBX 20	64	IHX 40	68	MH 116 R	34	MH 192 B	36
F 57524	43	HBX 23	64	IMX 10	68	MH 117	34	MH 192 C	36
F 57525 A	43	HBX 30	60	JNR 03	69	MH 117 R	34	MH 192 D	36
F 57526	43	HBX 32	60	JNR 04	69	MH 118	34	MH 192 E	36
F 57527	43	HBX 33	60	JNR 06	69	MH 118 R	34	MH 192 F	36
F 57528	43	HBX 485	60	JNR 07	69	MH 120	34	MH 192 G	36
F 57529	43	HBX 486	60	JNR 08	69	MH 120 R	34	MH 193 A	36
F 57531	43	HHK 35	67	JNR 041	69	MH 123	39	MH 193 B	36
F 57534	43	HHK 36	67	LR 501	53	MH 125	39	MH 193 C	36
F 57534 A	43	HHX 35	67	LR 502	53	MH 126	39	MH 193 D	36
F 57535	43	HMS 14	60	LR 503	53	MH 127	39	MH 193 E	36
F 57538	43	IBC 15	64	LR 601	53	MH 128 A	39	MH 193 F	36
F 57902	44	IBC 31	64	LR 602	53	MH 128 B	39	MH 193 G	36
F 57903	44	IBC 32	64	LR 603	53	MH 128 C	39	MH 194 A	36
HBC 27	60	IBC 54	64	LR 1301	54	MH 128 D	39	MH 194 B	36
HBC 28	60	IBC 57	65	MH 108 A	34	MH 128 E	39	MH 194 C	36
HBC 31	64	IBC 59	65	MH 108 B	34	MH 128 F	39	MH 194 D	36
HBC 32	64	IBC 60	65	MH 108 C	34	MH 128 G	39	MH 194 E	36

index

TYPE	PAGE	TYPE	PAGE	TYPE	PAGE	TYPE	PAGE	TYPE	PAGE
MH 194 F	36	MH 261 D	35	MH 423	40	N 42	75	R 2943 A	58
MH 194 G	36	MH 261 F	35	MH 565	31	R 2605 A	64	R 2943 B	58
MH 195 A	36	MH 276	37	MH 566	31	R 2606 A	64	R 2960	67
MH 195 B	36	MH 277	37	MH 567	31	R 2639	65	R 2967 A	63
MH 195 C	36	MH 278	37	MH 568	31	R 2643 A	68	R 2967 B	63
MH 195 D	36	MH 303	38	MH 569	31	R 2648 A	68	R 2968	67
MH 195 E	36	MH 305	38	MH 571	31	R 2649	68	R 2969 A	63
MH 195 F	36	MH 306	38	MH 573	31	R 2652 A	64	R 2971 B	63
MH 195 G	36	MH 307	38	MH 575	31	R 2663	64	R 2974 B	63
MH 207	39	MH 308	38	MH 702	61	R 2663 A	64	R 2976	67
MH 208	39	MH 309	38	MH 703	61	R 2663 B	64	R 2978 B	70
MH 209	39	MH 310	38	MH 712	59	R 2664	64	R 2980	66
MH 222	35	MH 331 A	37	MH 713	59	R 2665 A	64	R 2981	60
MH 223	35	MH 331 B	37	MH 752-1	33	R 2666	65	R 2986	64
MH 224	35	MH 331 C	37	MH 753-1	33	R 2668 B	68	R 2986 A	64
MH 225	35	MH 331 D	37	MH 754-1	33	R 2673	68	R 2987	60
MH 226	35	MH 331 E	37	MH 755-1	33	R 2673 A	64	R 2988 A	57
MH 227	35	MH 331 F	37	MH 756-1	33	R 2673 B	64	R 2989 A	58
MH 228	35	MH 331 G	37	MH 757-1	33	R 2681	68	R 2989 B	58
MH 238 A	35	MH 341 A	37	MH 758-1	33	R 2681 A	68	R 2992	67
MH 238 B	35	MH 341 B	37	MH 759-1	33	R 2690	65	R 2996	64
MH 238 C	35	MH 341 C	37	MH 759-2	33	R 2690 D	65	R 2997	67
MH 238 D	35	MH 341 D	37	MH 765-1	33	R 2694 C	61	R 2997 A	67
MH 238 E	35	MH 341 E	37	MH 768-1	33	R 2695 A	61	R 2997 B	67
MH 238 F	35	MH 341 F	37	MH 769-1	33	R 2695 C	61	R 2997 D	67
MH 238 G	35	MH 341 G	37	MH 769-2	33	R 2761	70	R 2998	67
MH 239 A	35	MH 381 A	38	MH 769-3	33	R 2763	70	R 2998 A	67
MH 239 B	35	MH 381 B	38	MH 772-1	33	R 2764	70	R 2998 C	67
MH 239 C	35	MH 381 C	38	MH 772-2	33	R 2850	72	SE 100	47
MH 239 D	35	MH 381 D	38	MH 774-1	33	R 2851	72	SE 101	47
MH 239 E	35	MH 381 E	38	MH 774-2	33	R 2853	72	SE 110	47
MH 239 F	35	MH 381 F	38	MH 776-1	33	R 2856	72	SE 111	47
MH 239 G	35	MH 381 G	38	MH 776-2	33	R 2857	72	SE 112	47
MH 240	35	MH 383 A	38	MH 776-3	33	R 2857 A	72	SE 113	47
MH 241	35	MH 383 B	38	MH 786-1	33	R 2861	72	SE 114	47
MH 245	35	MH 383 C	38	MI 001	69	R 2861 A	72	SE 115	47
MH 246	35	MH 383 D	38	MI 002	69	R 2862	71	SE 120	47
MH 247	35	MH 391 A	38	MI 005	69	R 2863	71	SE 121	47
MH 248	35	MH 391 B	38	MI 006	69	R 2864	71	SE 122	47
MH 249	35	MH 391 C	38	MI 007	69	R 2864 A	71	SE 123	47
MH 250	36	MH 391 D	38	MI 012	69	R 2865	71	SE 124	47
MH 251	36	MH 391 E	38	N 21	75	R 2865 A	71	SE 125	47
MH 255	36	MH 391 F	38	N 24	75	R 2900 A	67	SE 143	47
MH 256	36	MH 391 G	38	N 25	75	R 2908 B	63	SE 144	47
MH 257	36	MH 393 A	38	N 26	75	R 2908 D	63	SE 145	47
MH 258	36	MH 393 B	38	N 27	75	R 2908 F	63	SE 146	47
MH 259	36	MH 393 C	38	N 28	75	R 2916 B	58	SE 147	47
MH 261 A	35	MH 393 D	38	N 29	75	R 2921 A	66	SE 148	47
MH 261 B	35	MH 421	40	N 40	75	R 2921 B	66	SE 149	47
MH 261 C	35	MH 422	40	N 41	75	R 2922 A	70	SE 150	47

index

TYPE	PAGE	TYPE	PAGE	TYPE	PAGE	TYPE	PAGE	TYPE	PAGE
SE 151	47	SR 143	48	TBK 21	63	TBU 31	57	TC 9312	26
SE 152	47	SR 199	49	TBK 22	63	TBU 45	57	TC 9402	26
SE 153	47	SR 320	49	TBK 23	63	TBU 46	57	TC 9403	26
SE 154	47	SR 321	49	TBK 32	59	TBU 47	57	TC 9501	26
SE 155	47	SR 322	49	TBK 34	59	TBU 48	57	TC 9502	26
SE 156	47	SR 500	48	TBK 36	59	TBU 62	57	TC 9601	26
SE 157	47	SR 501	48	TBK 38	59	TBU 481	57	TH 5102	31
SE 158	47	SR 554	48	TBK 40 M	59	TBX 01	63	TH 5109	31
SE 159	47	SR 555	48	TBK 53	63	TBX 05	63	TH 5111	31
SE 210	47	TBC 20	59	TBK 70	63	TBX 30	59	TH 5112	31
SE 211	47	TBC 21	58	TBK 71	63	TBX 32	59	TH 5114	31
SE 212	47	TBC 22	58	TBK 323	59	TBX 33	59	TH 5115	31
SE 213	47	TBC 23	58	TBK 353	59	TBX 34	59	TH 5118	31
SE 214	47	TBC 29	58	TBK 363	59	TBX 36	59	TH 5124	31
SE 215	47	TBC 32	58	TBK 373	59	TBX 38	59	TH 5129	32
SE 216	47	TBC 33	58	TBK 401	59	TBX 48	59	TH 5130	32
SE 217	47	TBC 34	58	TBK 402	59	TBX 231	63	TH 5206 A	53
SE 220	47	TBC 35	58	TBL 03	57	TBX 241	63	TH 5206 B	53
SE 221	47	TBC 41	58	TBL 04	57	TBX 251	63	TH 5206 C	53
SE 222	47	TBC 50	59	TBL 10	57	TBX 261	63	TH 5206 D	53
SE 223	47	TBC 51	58	TBL 11	57	TBX 302	59	TH 5207 A	53
SE 224	47	TBC 52	59	TBL 12	57	TBX 303	59	TH 5207 B	53
SE 225	47	TBC 54	58	TBL 14	58	TBX 312	58	TH 5207 C	53
SE 226	47	TBC 60	58	TBL 20	57	TBX 313	58	TH 5207 D	53
SE 227	47	TBC 62	58	TBL 21	57	TBX 314	58	TH 5208	53
SE 244	47	TBC 64	58	TBL 30	57	TBX 325	59	TH 5213	53
SE 245	47	TBC 66	58	TBL 41	57	TBX 343	59	TH 5216 A	53
SE 246	47	TBC 74	63	TBL 51	57	TBX 353	59	TH 5216 B	53
SE 247	47	TBC 87	63	TBL 52	57	TBX 363	59	TH 5216 C	53
SE 300	49	TBC 88	63	TBL 53	57	TBX 383	59	TH 5216 C	53
SE 301	49	TBC 96	63	TBL 54	57	TBX 481	59	TH 5216 E	53
SE 350	49	TBC 141	63	TBL 55	59	TC 1100	27	TH 5216 F	53
SE 351	49	TBC 151	63	TBL 511	57	TC 1101	27	TH 5216 G	53
SE 400	49	TBC 152	63	TBS 13	58	TC 1400	27	TH 5216 H	53
SE 500	48	TBC 281	58	TBS 22	58	TC 3200	25	TH 5216 I	53
SE 501	48	TBC 282	58	TBS 25	58	TC 3201	25	TH 5216 J	53
SE 554	48	TBC 541	58	TBS 26	58	TC 3400	25	TH 5216 L	53
SE 555	48	TBC 612	58	TBS 40	59	TC 3401	25	TH 5216 M	53
SE 700	49	TBC 621	58	TBS 41	58	TC 3500	25	TH 5216 R	53
SE 701	49	TBC 623	58	TBS 50	59	TC 4200	25	TH 5219	54
SE 750	49	TBC 625	58	TBS 51	58	TC 4250	25	TH 5221 A	53
SE 751	49	TBC 631	58	TBS 52	58	TC 4400	25	TH 5221 D	53
SR 100	48	TBC 635	58	TBS 60	58	TC 4500	25	TH 5221 G	53
SR 101	48	TBC 643	58	TBS 61	58	TC 5200	25	TH 5227	53
SR 110	48	TBC 651	58	TBS 80	63	TC 5201	25	TH 5228 E	53
SR 111	48	TBC 661	58	TBS 221	58	TC 5250	25	TH 5237	53
SR 120	48	TBC 663	58	TBS 255	58	TC 5251	25	TH 5239	53
SR 121	48	TBC 751	63	TBS 411	58	TC 9302	26	TH 5243	53
SR 141	48	TBC 781	63	TBS 511	58	TC 9303	26	TH 5252	53
SR 142	48	TBK 10	63	TBU 30	57	TC 9311	26	TH 5263	53

index

TYPE	PAGE	TYPE	PAGE	TYPE	PAGE	TYPE	PAGE	TYPE	PAGE
TH 5264	53	Y 11	74	YBU 29	66				
TH 5269	53	Y 12	74	YBU 63	57				
TH 5277	53	Y 13	74	YBU 64	57				
TH 5278	53 - 44	Y 14	74	YBU 64-1	57				
TH 5279 A	53	Y 15	74	YBU 66	57				
TH 5279 B	53	Y 30	74	YBU 68	57				
TH 5279 C	53	Y 31	74	YHA 40	66				
TH 5279 D	53	Y 32	74	YHA 41	66				
TH 5279 E	53	Y 33	74	YHA 42	66				
TH 5281	53	Y 34	74	YHA 43	66				
TH 5285	53	Y 35	74	YHA 44	66				
TH 5286	53	Y 36	74	YHA 45	66				
TH 8021 C	17	Y 37	74	YHA 46	66				
TH 8021 D	17	Y 38	74	YHB 40	66				
TH 8023 C	17	Y 39	74	YHU 07	66				
TH 8023 D	17	Y 71	74	YHU 08	66				
TH 8023 E	17	Y 72	74	YHU 09	66				
TH 8031	17	Y 74	74	YMA 45	66				
TH 8032	17	Y 75	74	YMA 46	66				
TH 8049	17	Y 76	74						
TH 8121 C	17	Y 77	74						
TH 8121 D	17	Y 78	74						
TH 8123 C	17	Y 86	74						
TH 8123 D	17	Y 91	74						
TH 8123 E	17	Y 94	74						
TH 8131	17	Y 101	74						
TH 8132	17	Y 209	74						
TH 8149	17	Y 215	74						
TH 8231	17	Y 219	74						
TH 8249	17	Y 220	74						
THC 34	66	Y 705	74						
THK 35	66	Y 708	74						
THX 35	66	Y 710	74						
TMC 541	63	Y 908	74						
TMS 13	58	YBA 45	57						
TMS 15	58	YBA 46	57						
TMS 35	66	YBS 13	58						
TMS 36	66	YBS 20	58						
TMS 361	66	YBU 06	57						
TMU 06	57	YBU 07	57						
TMU 09	57	YBY 08	57						
TMX 10	63	YBU 09	57						
TMX 11	63	YBU 11	57						
TMX 14	63	YBU 16	57						
U 20	75	YBU 17	57						
U 21	75	YBU 18	57						
U 30	75	YBU 19	57						
U 32	75	YBU 26	66						
U 33	75	YBU 27	66						
Y 10	74	YBU 28	66						

SURVEILLANCE DE LA QUALITE

Le niveau de la qualité des modèles livrés, après stabilisation à haute température, est vérifié périodiquement par prélèvement selon les essais décrits ci-dessous, conformément au plan de contrôle défini dans les spécifications particulières ou le catalogue.

SUPERVISION OF THE QUALITY

The quality level of delivery models, after high temperature stabilization, is verified periodically by sampling, as required by the tests described below, in accordance with the plan of control set out in the detail specifications or the catalogue.

TESTS \ CONDITIONS		1	2	3	4	DOCUMENTS		
						NFC	IEC	MIL STD
A	Variation rapide de température Rapid change of temperature	- 55°C + 100°C 5 cycles 1/2 heure - hour	- 55°C + 125°C 5 cycles 1/2 heure - hour	- 65°C + 155°C 5 cycles 1/2 heure - hour	Cahier des charges Detail SP	20.605	68.2.14/Na	750/1051
B	Chocs thermiques Thermal shocks	0°C + 100°C 5 cycles	- 40°C + 85°C 5 cycles	- 55°C + 125°C 5 cycles	Cahier des charges Detail SP	20.605	68.2.14/Nc	750/1056
C	Chocs mécaniques Mechanical shocks	11 ms, 50 g 3 chocs - shocks 3 axes	1 ms, 500 g 3 chocs - shocks 3 axes	0,5 ms, 1500 g 3 chocs - shocks 3 axes	Cahier des charges Detail SP	20.608	68.2.27/Ea	750/2016
D	Vibrations sinusoïdales Sinusoidal vibrations	10 Hz - 500 Hz 10 g - 3 axes 3 cycles 15 mn	20 Hz - 2000 Hz 20 g - 3 axes 3 cycles 20 mn	100 Hz - 2000 Hz 40 g - 3 axes 3 cycles 20 mn	Résonance 20 g - 3 axes 1 cycle 60 mn	20.616	68.2.6/Fc	750/2056
E	Accélération constante Constant acceleration	200 g 3 axes 5 minutes	2000 g 3 axes 5 minutes	5000 g 3 axes 1 minute	20 000 G 3 axes 1 minute	20.623	68.2.7/Ga	750/2006
F	Herméticité Etanchéité Seal tests	FC 43	HELIUM FC 43	Essai à la bombe Bomb pressure test	Cahier des charges Detail SP	20.625 93.001 21 A/A1	68.2.17/0	750/1071/H 750/1071/C1
G	Chaleur humide (cycle continu) Damp heat (steady state)	10 jours 10 days 40°C 93 %	21 jours 21 days 40°C 93 %	56 jours 56 days 40°C 93 %	Essai combiné climatique Damp heat (cyclic)	20.603	68.2.3/Ca	750/1021
H	Fonctionnement simulé Operating life	Blocage à chaud H T R B	Débit direct Power burn in	Vieillesse accélérée Accelerated aging	Cahier des charges Detail SP	20.602	68.2.2/Ba	750/1038



DIVISION COMPOSANTS MICROONDE



THOMSON-CSF

DIVISION COMPOSANTS MICROONDE
101, bd Murat - 75781 PARIS Cédex 16 / FRANCE
Tél.: (33.1) 743.96.40 / Télex : 204780 TCSF F

RESEAU DE VENTE INTERNATIONAL INTERNATIONAL SALES NETWORK

FILIALES THOMSON-CSF COMPOSANTS THOMSON-CSF COMPONENTS SUBSIDIARIES

BELGIQUE

BENELUX

THOMSON S.A.N.V.
DEPARTEMENT COMPOSANTS ET TUBES
363. AV. LOUISE B.P. 10
B. 1050 BRUXELLES
TEL.: (2) 648.64.85
TELEX : 23113 THBXL - B

BRESIL

BRAZIL

THOMSON-CSF
COMPONENTES DO BRASIL
AV. ROQUE PETRONIO JR.
CAIXA POSTAL 4854
SAO PAULO
TEL.: (11) 542.47.22
TELEX : 1124226 TCSF - BR

ESPAÑE

SPAIN

THOMSON-CSF COMPONENTES
Y TUBOS S.A.
CALLE ALMAGRO, 3
MADRID 4
TEL.: (1) 419.85.37
TELEX : 46033 TCCE-E

ETATS-UNIS

U.S.A.

THOMSON-CSF
COMPONENTS CORPORATION
SPECIAL PRODUCTS DIVISION
750 BLOOMFIELD AVENUE
CLIFTON N.J. 07015
TEL.: (201) 779.1004
TELEX : 579897149 DUMONT CLFT

ITALIE

ITALY

THOMSON-CSF COMPONENTI
VIA MELCHIORRE GIOIA 72
20125 MILANO
TEL.: (2) 688.41.41
TELEX : 330301 THOMCO - I

JAPON

JAPAN

THOMSON-CSF JAPAN K.K.
COMPONENTS AND TUBES DEPARTMENT
TBR BUILDING 701
KOJIMACHI 5-7, CHIYODA-KU
TOKYO 102
TEL.: (3) 264.63.41
TELEX : (0) 2324241 THCSF - J

RFA

WEST GERMANY

THOMSON-CSF BAUELEMENTE GmbH
FALLSTRASSE 42
D-8000 MUNCHEN 70
TEL.: (89) 76.75.1
TELEX : 522916 CSF 6 D

ROYAUME-UNI

UNITED KINGDOM

THOMSON-CSF
COMPONENTS AND MATERIALS Ltd
RINGWAY HOUSE
BELL ROAD
BASINGSTOKE
HANTS RG24 0QG
TEL.: (256) 29.155
TELEX : 858865 TESAFI - G

SUEDE

SWEDEN

THOMSON-CSF
KOMPONENTER & ELEKTRONIK AB
SANDHAMNSGATAN 67
BOX 27080
S-102.51 - STOCKHOLM 27
TEL.: (8) 22.58.15
TELEX : 12078 THCSF - S

AGENTS ET DISTRIBUTEURS

FOREIGN AGENTS AND DISTRIBUTORS

DANEMARK

DENMARK

SCANSUPPLY
20, NANNASGADE
DK - 2200 - COPENHAGEN N
TEL.: (1) 83.50.90
TELEX : 19037 SCAPLY - DK

FINLANDE

FINLAND

OY TOP COMPONENTS AB
RUUSULANKATU 20 A 12
0250 - HELSINKI 25
TEL.: (0) 49.01.37
TELEX : 123333 SUFRA - SF

NORVEGE

NORWAY

TAHONIC A/S
POSTBOKS 140
KALDBAKKEN
OSLO 9
TEL.: (2) 16.16.10
TELEX : 17397 TONIC - N

SUISSE

SWITZERLAND

MODULATOR S.A.
KONIZSTRASSE 194
CH - 3097 - LIEBEFELD-BERN
TEL.: (31) 59.22.22
TELEX : 32431 MÖBER - CH

AUTRES PAYS

OTHER COUNTRIES

THOMSON-CSF COMPOSANTS EXPORT
101 BOULEVARD MURAT
75781 PARIS CEDEX 16 - FRANCE
TEL.: (33.1) 743.96.40
TELEX : 204780 TCSF F

