

# LM6171

## High Speed Low Power Low Distortion Voltage Feedback Amplifier

### General Description

The LM6171 is a high speed unity-gain stable voltage feedback amplifier. It offers a high slew rate of 3600V/ $\mu$ s and a unity-gain bandwidth of 100 MHz while consuming only 2.5 mA of supply current. The LM6171 has very impressive AC and DC performance which is a great benefit for high speed signal processing and video applications.

The  $\pm 15$ V power supplies allow for large signal swings and give greater dynamic range and signal-to-noise ratio. The LM6171 has high output current drive, low SFDR and THD, ideal for ADC/DAC systems. The LM6171 is specified for  $\pm 5$ V operation for portable applications.

The LM6171 is built on National's advanced VIP™ III (Vertically Integrated PNP) complementary bipolar process.

### Features

(Typical Unless Otherwise Noted)

- Easy-To-Use Voltage Feedback Topology
- Very High Slew Rate: 3600V/ $\mu$ s
- Wide Unity-Gain-Bandwidth Product: 100 MHz
- -3dB Frequency @  $A_V = +2$ : 62 MHz
- Low Supply Current: 2.5 mA
- High CMRR: 110 dB
- High Open Loop Gain: 90 dB
- Specified for  $\pm 15$ V and  $\pm 5$ V Operation

### Applications

- Multimedia Broadcast Systems
- Line Drivers, Switchers
- Video Amplifiers
- NTSC, PAL® and SECAM Systems
- ADC/DAC Buffers
- HDTV Amplifiers
- Pulse Amplifiers and Peak Detectors
- Instrumentation Amplifier
- Active Filters

### Typical Performance Characteristics

Closed Loop Frequency Response vs. Supply Voltage  
( $A_V = +1$ )

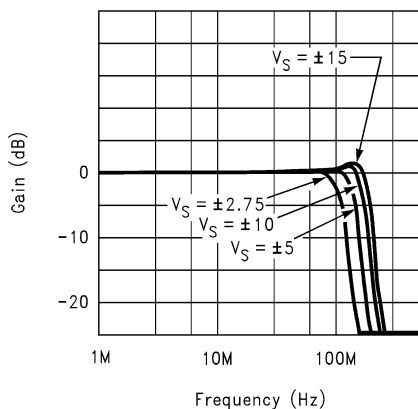

Large Signal Pulse Response  
 $A_V = +1$ ,  $V_S = \pm 15$

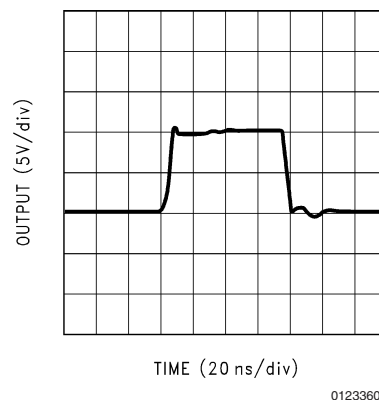

## Connection Diagram

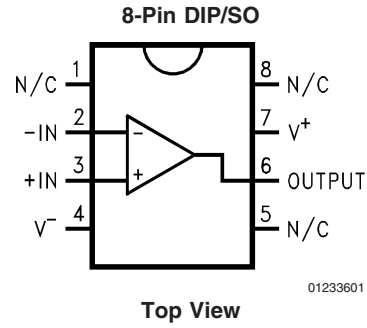

## Ordering Information

Package	Temperature Range	Transport Media	NSC Drawing
	Industrial -40°C to +85°C		
8-Pin Molded DIP	LM6171AIN LM6171BIN	Rails	N08E
8-Pin Small Outline	LM6171AIM, LM6171BIM	Rails	M08A
	LM6171AIMX, LM6171BIMX	2.5k Units Tape and Reel	

**Absolute Maximum Ratings** (Note 1)

If Military/Aerospace specified devices are required, please contact the National Semiconductor Sales Office/Distributors for availability and specifications.

ESD Tolerance (Note 2)	2.5 kV
Supply Voltage ( $V^+ - V^-$ )	36V
Differential Input Voltage	$\pm 10V$
Common-Mode Voltage Range	$V^+ + 0.3V$ to $V^- - 0.3V$
Input Current	$\pm 10mA$
Output Short Circuit to Ground (Note 3)	Continuous
Storage Temperature Range	$-65^\circ C$ to $+150^\circ C$
Maximum Junction Temperature (Note 4)	$150^\circ C$

## Soldering Information

Infrared or Convection Reflow (20 sec.)	$235^\circ C$
Wave Soldering Lead Temp (10 sec.)	$260^\circ C$

**Operating Ratings** (Note 1)

Supply Voltage	$5.5V \leq V_S \leq 34V$
Operating Temperature Range	$-40^\circ C$ to $+85^\circ C$
LM6171AI, LM6171BI	
Thermal Resistance ( $\theta_{JA}$ )	
N Package, 8-Pin Molded DIP	$108^\circ C/W$
M Package, 8-Pin Surface Mount	$172^\circ C/W$

 **$\pm 15V$  DC Electrical Characteristics**

Unless otherwise specified, all limits guaranteed for  $T_J = 25^\circ C$ ,  $V^+ = +15V$ ,  $V^- = -15V$ ,  $V_{CM} = 0V$ , and  $R_L = 1 k\Omega$ . **Boldface** limits apply at the temperature extremes

Symbol	Parameter	Conditions	Typ (Note 5)	LM6171AI Limit (Note 6)	LM6171BI Limit (Note 6)	Units
$V_{OS}$	Input Offset Voltage		1.5	3 <b>5</b>	6 <b>8</b>	mV max
TC $V_{OS}$	Input Offset Voltage Average Drift		6			$\mu V/^\circ C$
$I_B$	Input Bias Current		1	3 <b>4</b>	3 <b>4</b>	$\mu A$ max
$I_{OS}$	Input Offset Current		0.03	2 <b>3</b>	2 <b>3</b>	$\mu A$ max
$R_{IN}$	Input Resistance	Common Mode	40			$M\Omega$
		Differential Mode	4.9			
$R_O$	Open Loop Output Resistance		14			$\Omega$
CMRR	Common Mode Rejection Ratio	$V_{CM} = \pm 10V$	110	80 <b>75</b>	75 <b>70</b>	dB min
PSRR	Power Supply Rejection Ratio	$V_S = \pm 15V$ to $\pm 5V$	95	85 <b>80</b>	80 <b>75</b>	dB min
$V_{CM}$	Input Common-Mode Voltage Range	CMRR $\geq 60$ dB	$\pm 13.5$			V
$A_V$	Large Signal Voltage Gain (Note 7)	$R_L = 1 k\Omega$	90	80 <b>70</b>	80 <b>70</b>	dB min
		$R_L = 100\Omega$	83	70 <b>60</b>	70 <b>60</b>	dB min
$V_O$	Output Swing	$R_L = 1 k\Omega$	13.3	12.5 <b>12</b>	12.5 <b>12</b>	V min
			-13.3	-12.5 <b>-12</b>	-12.5 <b>-12</b>	V max
		$R_L = 100\Omega$	11.6	9 <b>8.5</b>	9 <b>8.5</b>	V min
			-10.5	-9 <b>-8.5</b>	-9 <b>-8.5</b>	V max
	Continuous Output Current (Open Loop) (Note 8)	Sourcing, $R_L = 100\Omega$	116	90 <b>85</b>	90 <b>85</b>	mA min

**±15V DC Electrical Characteristics** (Continued)

Unless otherwise specified, all limits guaranteed for  $T_J = 25^\circ\text{C}$ ,  $V^+ = +15\text{V}$ ,  $V^- = -15\text{V}$ ,  $V_{CM} = 0\text{V}$ , and  $R_L = 1\text{ k}\Omega$ . **Boldface** limits apply at the temperature extremes

Symbol	Parameter	Conditions	Typ (Note 5)	LM6171AI Limit (Note 6)	LM6171BI Limit (Note 6)	Units
		Sinking, $R_L = 100\Omega$	105	90 <b>85</b>	90 <b>85</b>	mA max
	Continuous Output Current (in Linear Region)	Sourcing, $R_L = 10\Omega$	100			mA
		Sinking, $R_L = 10\Omega$	80			mA
$I_{SC}$	Output Short Circuit Current	Sourcing	135			mA
		Sinking	135			mA
$I_S$	Supply Current		2.5	4 <b>4.5</b>	4 <b>4.5</b>	mA max

**±15V AC Electrical Characteristics**

Unless otherwise specified, all limits guaranteed for  $T_J = 25^\circ\text{C}$ ,  $V^+ = +15\text{V}$ ,  $V^- = -15\text{V}$ ,  $V_{CM} = 0\text{V}$ , and  $R_L = 1\text{ k}\Omega$ . **Boldface** limits apply at the temperature extremes

Symbol	Parameter	Conditions	Typ (Note 5)	LM6171AI Limit (Note 6)	LM6171BI Limit (Note 6)	Units
SR	Slew Rate (Note 9)	$A_V = +2$ , $V_{IN} = 13\text{ V}_{PP}$	3600			V/ $\mu\text{s}$
		$A_V = +2$ , $V_{IN} = 10\text{ V}_{PP}$	3000			
GBW	Unity Gain-Bandwidth Product		100			MHz
	-3 dB Frequency	$A_V = +1$	160			MHz
		$A_V = +2$	62			MHz
$\phi_m$	Phase Margin		40			deg
$t_s$	Settling Time (0.1%)	$A_V = -1$ , $V_{OUT} = \pm 5\text{V}$ $R_L = 500\Omega$	48			ns
	Propagation Delay	$V_{IN} = \pm 5\text{V}$ , $R_L = 500\Omega$ , $A_V = -2$	6			ns
$A_D$	Differential Gain (Note 10)		0.03			%
$\phi_D$	Differential Phase (Note 10)		0.5			deg
$e_n$	Input-Referred Voltage Noise	$f = 1\text{ kHz}$	12			$\frac{\text{nV}}{\sqrt{\text{Hz}}}$
$i_n$	Input-Referred Current Noise	$f = 1\text{ kHz}$	1			$\frac{\text{pA}}{\sqrt{\text{Hz}}}$

**±5V DC Electrical Characteristics**

Unless otherwise specified, all limits guaranteed for  $T_J = 25^\circ\text{C}$ ,  $V^+ = +5\text{V}$ ,  $V^- = -5\text{V}$ ,  $V_{CM} = 0\text{V}$ , and  $R_L = 1\text{ k}\Omega$ . **Boldface** limits apply at the temperature extremes

Symbol	Parameter	Conditions	Typ (Note 5)	LM6171AI Limit (Note 6)	LM6171BI Limit (Note 6)	Units
$V_{OS}$	Input Offset Voltage		1.2	3 <b>5</b>	6 <b>8</b>	mV max
TC $V_{OS}$	Input Offset Voltage Average Drift		4			$\mu\text{V}/^\circ\text{C}$
$I_B$	Input Bias Current		1	2.5 <b>3.5</b>	2.5 <b>3.5</b>	$\mu\text{A}$ max
$I_{OS}$	Input Offset Current		0.03	1.5	1.5	$\mu\text{A}$

**±5V DC Electrical Characteristics** (Continued)

Unless otherwise specified, all limits guaranteed for  $T_J = 25^\circ\text{C}$ ,  $V^+ = +5\text{V}$ ,  $V^- = -5\text{V}$ ,  $V_{\text{CM}} = 0\text{V}$ , and  $R_L = 1\text{ k}\Omega$ . **Boldface** limits apply at the temperature extremes

Symbol	Parameter	Conditions	Typ (Note 5)	LM6171AI Limit (Note 6)	LM6171BI Limit (Note 6)	Units
				<b>2.2</b>	<b>2.2</b>	max
$R_{\text{IN}}$	Input Resistance	Common Mode	40			$\text{M}\Omega$
		Differential Mode	4.9			
$R_{\text{O}}$	Open Loop Output Resistance		14			$\Omega$
CMRR	Common Mode Rejection Ratio	$V_{\text{CM}} = \pm 2.5\text{V}$	105	80	75	dB min
				<b>75</b>	<b>70</b>	
PSRR	Power Supply Rejection Ratio	$V_S = \pm 15\text{V to } \pm 5\text{V}$	95	85	80	dB min
				<b>80</b>	<b>75</b>	
$V_{\text{CM}}$	Input Common-Mode Voltage Range	CMRR $\geq 60\text{ dB}$	$\pm 3.7$			V
$A_V$	Large Signal Voltage Gain (Note 7)	$R_L = 1\text{ k}\Omega$	84	75	75	dB min
		$R_L = 100\Omega$	80	70	70	dB min
$V_{\text{O}}$	Output Swing	$R_L = 1\text{ k}\Omega$	3.5	3.2	3.2	V min
				-3.4	-3.2	-3.2
		$R_L = 100\Omega$	3.2	2.8	2.8	V min
				-3.0	-2.8	-2.8
	Continuous Output Current (Open Loop) (Note 8)	Sourcing, $R_L = 100\Omega$	32	28	28	mA min
		Sinking, $R_L = 100\Omega$	30	28	28	
$I_{\text{SC}}$	Output Short Circuit Current	Sourcing	130			mA
		Sinking	100			mA
$I_S$	Supply Current		2.3	3	3	mA
				<b>3.5</b>	<b>3.5</b>	max

**±5V AC Electrical Characteristics**

Unless otherwise specified, all limits guaranteed for  $T_J = 25^\circ\text{C}$ ,  $V^+ = +5\text{V}$ ,  $V^- = -5\text{V}$ ,  $V_{\text{CM}} = 0\text{V}$ , and  $R_L = 1\text{ k}\Omega$ . **Boldface** limits apply at the temperature extremes

Symbol	Parameter	Conditions	Typ (Note 5)	LM6171AI Limit (Note 6)	LM6171BI Limit (Note 6)	Units
SR	Slew Rate (Note 9)	$A_V = +2$ , $V_{\text{IN}} = 3.5 V_{\text{PP}}$	750			$\text{V}/\mu\text{s}$
GBW	Unity Gain-Bandwidth Product		70			MHz
		$A_V = +1$	130			
		$A_V = +2$	45			
$\phi_m$	Phase Margin		57			deg
$t_s$	Settling Time (0.1%)	$A_V = -1$ , $V_{\text{OUT}} = +1\text{V}$ , $R_L = 500\Omega$	60			ns

**±5V AC Electrical Characteristics** (Continued)

Unless otherwise specified, all limits guaranteed for  $T_J = 25^\circ\text{C}$ ,  $V^+ = +5\text{V}$ ,  $V^- = -5\text{V}$ ,  $V_{\text{CM}} = 0\text{V}$ , and  $R_L = 1\text{ k}\Omega$ . **Boldface** limits apply at the temperature extremes

Symbol	Parameter	Conditions	Typ (Note 5)	LM6171AI Limit (Note 6)	LM6171BI Limit (Note 6)	Units
	Propagation Delay	$V_{\text{IN}} = \pm 1\text{V}$ , $R_L = 500\Omega$ , $A_V = -2$	8			ns
$A_D$	Differential Gain (Note 10)		0.04			%
$\phi_D$	Differential Phase (Note 10)		0.7			deg
$e_n$	Input-Referred Voltage Noise	$f = 1\text{ kHz}$	11			$\frac{\text{nV}}{\sqrt{\text{Hz}}}$
$i_n$	Input-Referred Current Noise	$f = 1\text{ kHz}$	1			$\frac{\text{pA}}{\sqrt{\text{Hz}}}$

**Note 1:** Absolute Maximum Ratings indicate limits beyond which damage to the device may occur. Operating Ratings indicate conditions for which the device is intended to be functional, but specific performance is not guaranteed. For guaranteed specifications and the test conditions, see the Electrical Characteristics.

**Note 2:** Human body model, 1.5 k $\Omega$  in series with 100 pF.

**Note 3:** Continuous short circuit operation at elevated ambient temperature can result in exceeding the maximum allowed junction temperature of 150°C.

**Note 4:** The maximum power dissipation is a function of  $T_{\text{J(max)}}$ ,  $\theta_{\text{JA}}$ , and  $T_{\text{A}}$ . The maximum allowable power dissipation at any ambient temperature is  $P_D = (T_{\text{J(max)}} - T_{\text{A}})/\theta_{\text{JA}}$ . All numbers apply for packages soldered directly into a PC board.

**Note 5:** Typical Values represent the most likely parametric norm.

**Note 6:** All limits are guaranteed by testing or statistical analysis.

**Note 7:** Large signal voltage gain is the total output swing divided by the input signal required to produce that swing. For  $V_S = \pm 15\text{V}$ ,  $V_{\text{OUT}} = \pm 5\text{V}$ . For  $V_S = +5\text{V}$ ,  $V_{\text{OUT}} = \pm 1\text{V}$ .

**Note 8:** The open loop output current is the output swing with the 100 $\Omega$  load resistor divided by that resistor.

**Note 9:** Slew rate is the average of the rising and falling slew rates.

**Note 10:** Differential gain and phase are measured with  $A_V = +2$ ,  $V_{\text{IN}} = 1\text{ V}_{\text{PP}}$  at 3.58 MHz and both input and output 75 $\Omega$  terminated.

**Typical Performance Characteristics** Unless otherwise noted,  $T_A = 25^\circ\text{C}$

**Supply Current vs. Supply Voltage**

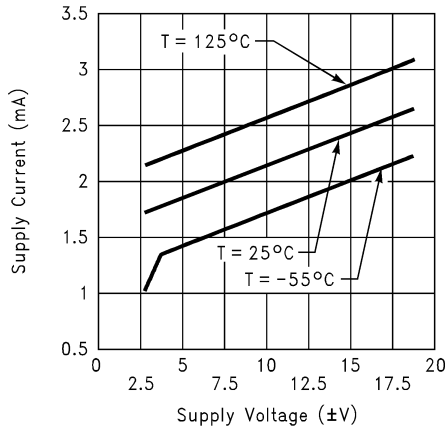

01233620

**Supply Current vs. Temperature**

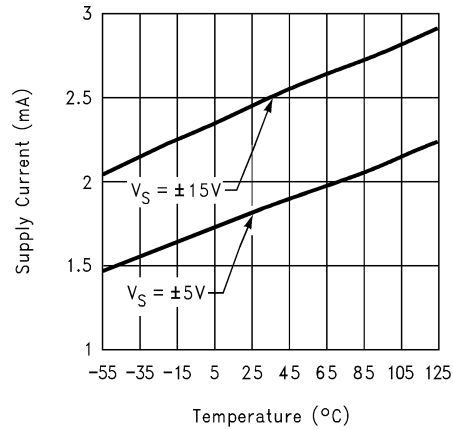

01233621

**Input Offset Voltage vs. Temperature**

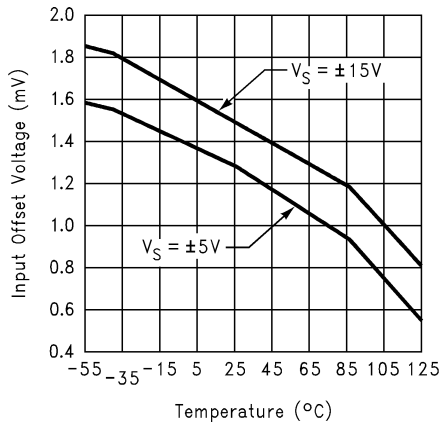

01233622

**Input Bias Current vs. Temperature**

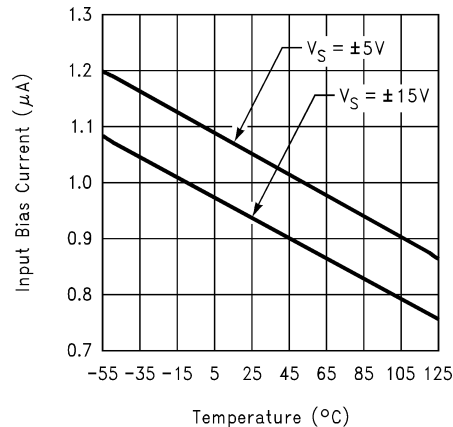

01233623

**Input Offset Voltage vs. Common Mode Voltage**

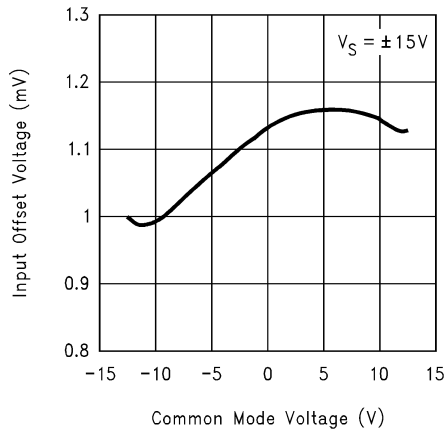

01233624

**Short Circuit Current vs. Temperature (Sourcing)**

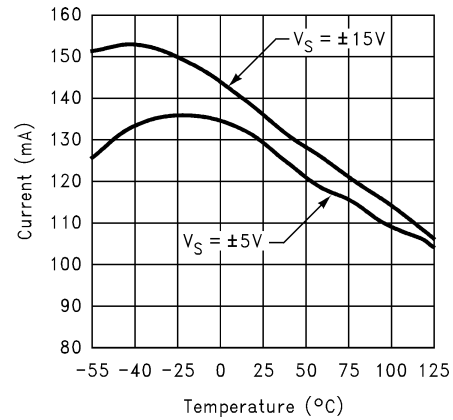

01233625

**Typical Performance Characteristics** Unless otherwise noted,  $T_A = 25^\circ\text{C}$  (Continued)

**Short Circuit Current vs. Temperature (Sinking)**

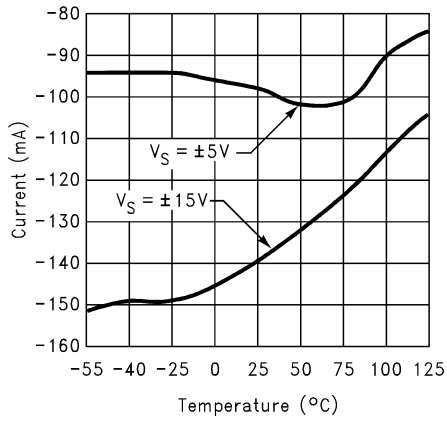

**Output Voltage vs. Output Current**

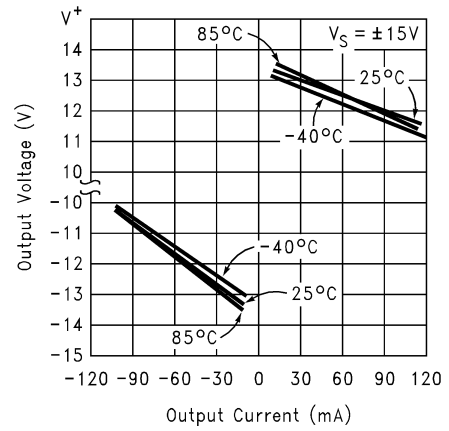

**Output Voltage vs. Output Current**

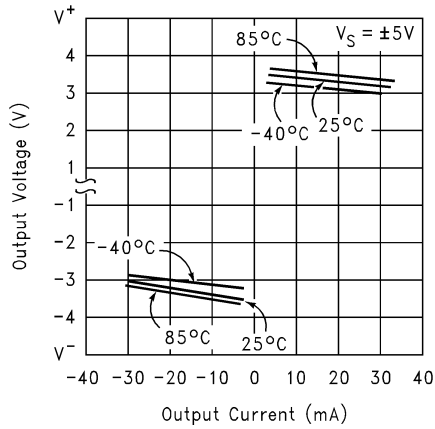

**CMRR vs. Frequency**

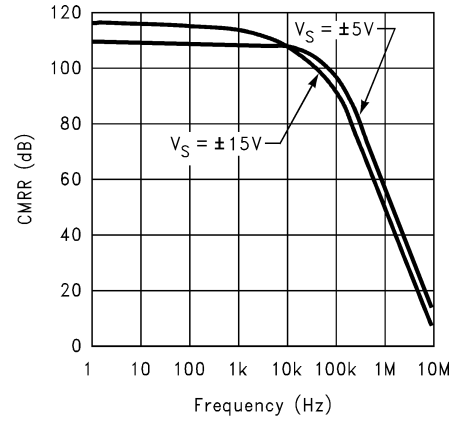

**PSRR vs. Frequency**

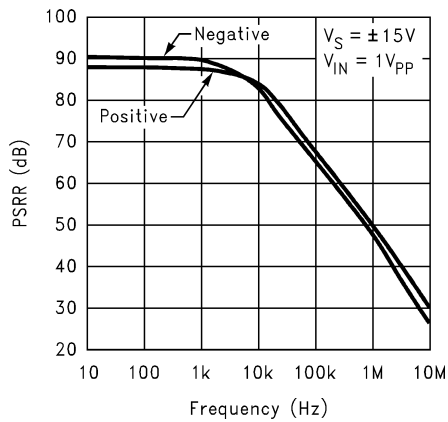

**PSRR vs. Frequency**

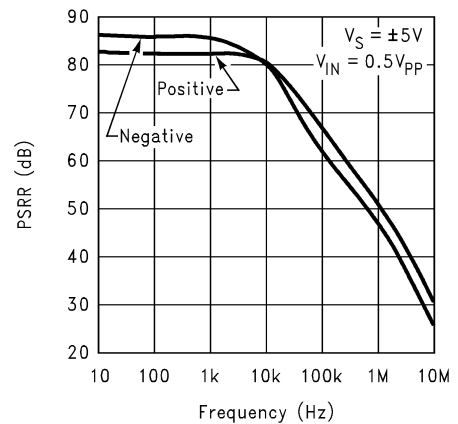



**Typical Performance Characteristics** Unless otherwise noted,  $T_A = 25^\circ\text{C}$  (Continued)

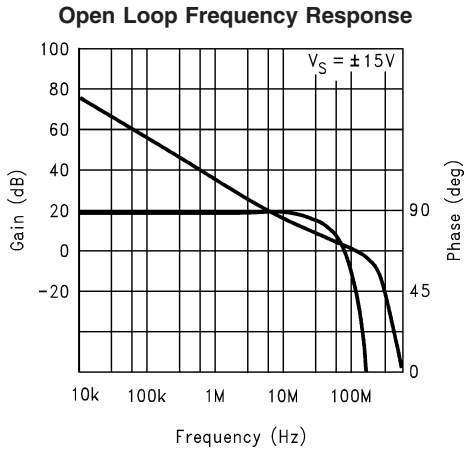

01233632

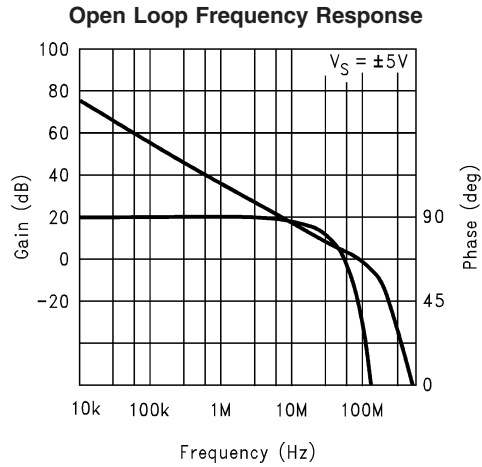

01233633

**Gain Bandwidth Product vs. Supply Voltage**

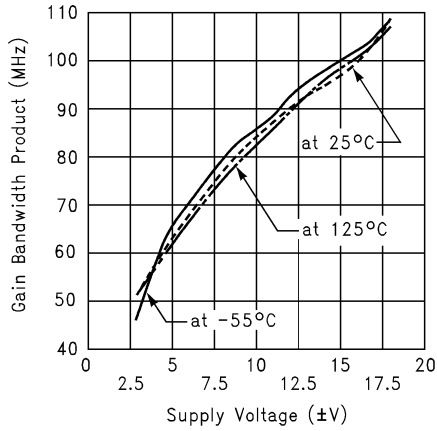

01233634

**Gain Bandwidth Product vs. Load Capacitance**

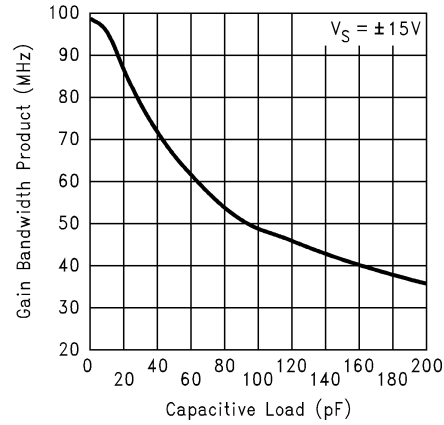

01233635

**Large Signal Voltage Gain vs. Load**

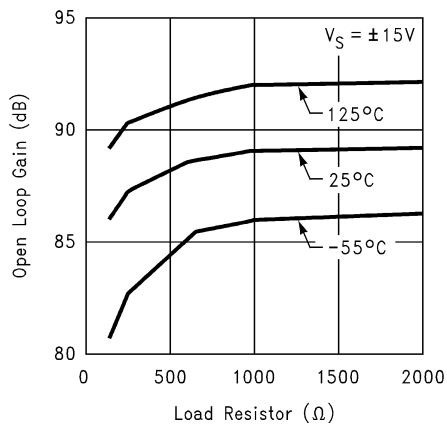

01233636

**Large Signal Voltage Gain vs. Load**

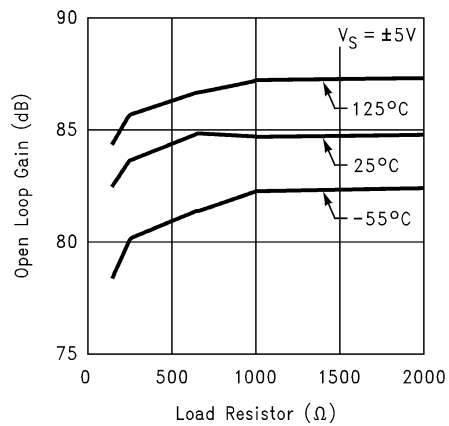

01233637

**Typical Performance Characteristics** Unless otherwise noted,  $T_A = 25^\circ\text{C}$  (Continued)

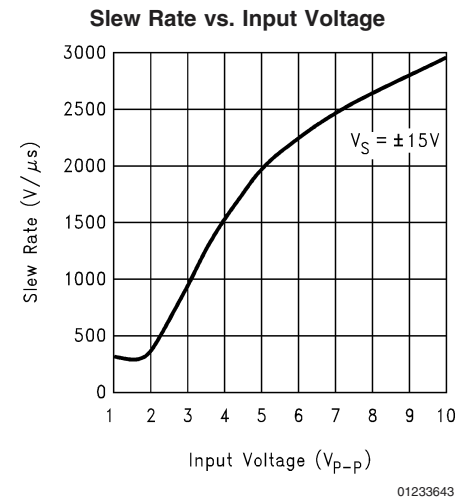
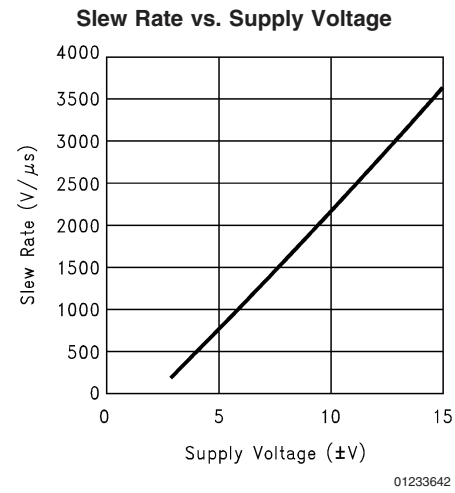
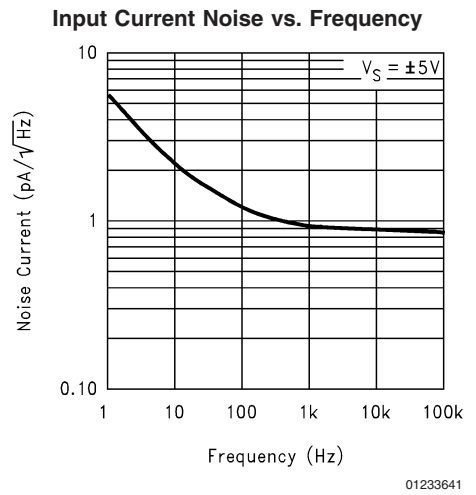
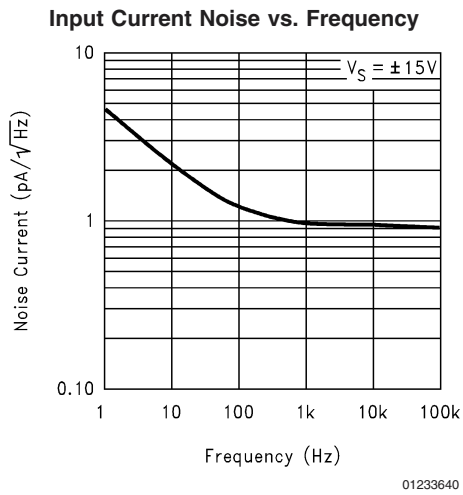
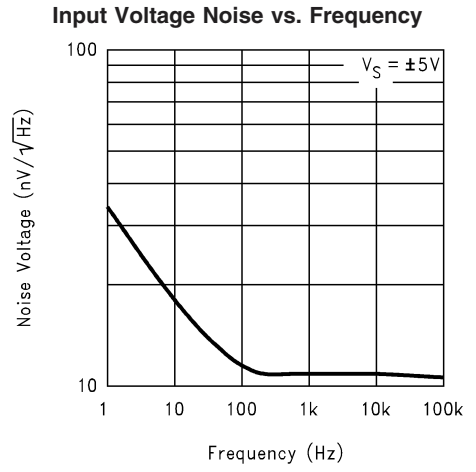
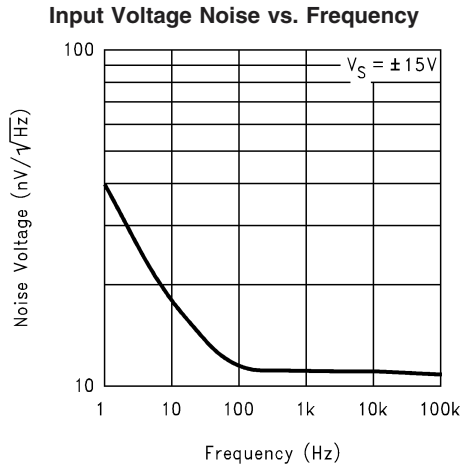

**Typical Performance Characteristics** Unless otherwise noted,  $T_A = 25^\circ\text{C}$  (Continued)

**Slew Rate vs. Load Capacitance**

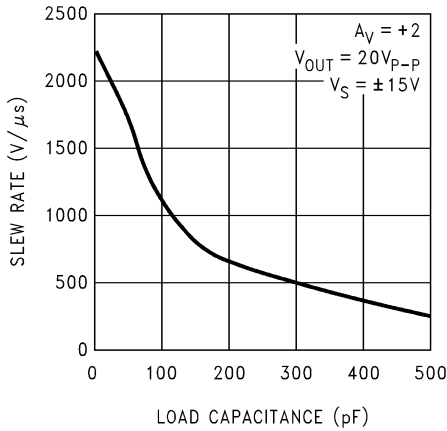

01233644

**Open Loop Output Impedance vs. Frequency**

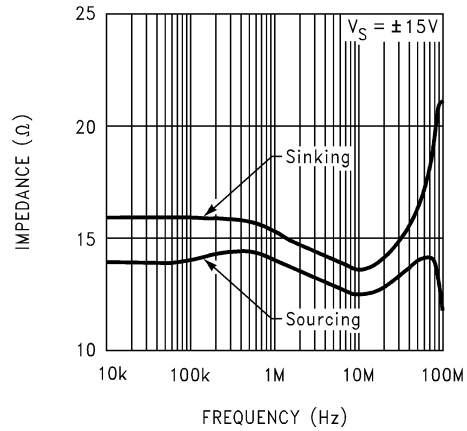

01233645

**Open Loop Output Impedance vs. Frequency**

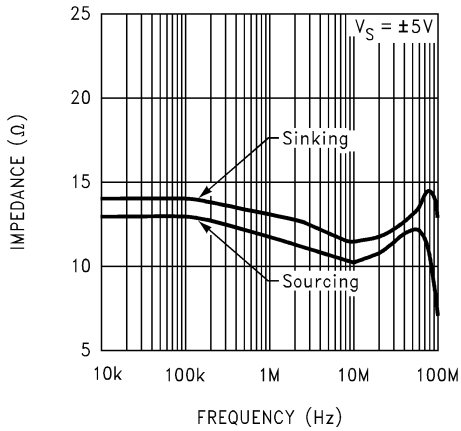

01233646

**Large Signal Pulse Response**  
 $A_V = -1, V_S = \pm 15V$

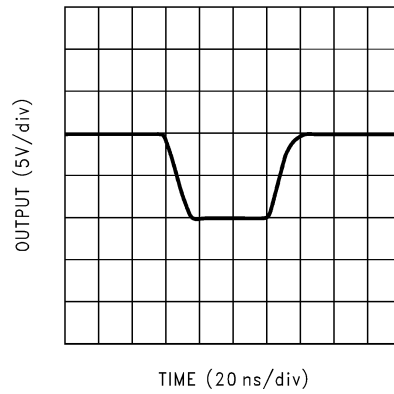

01233647

**Large Signal Pulse Response**  
 $A_V = -1, V_S = \pm 5V$

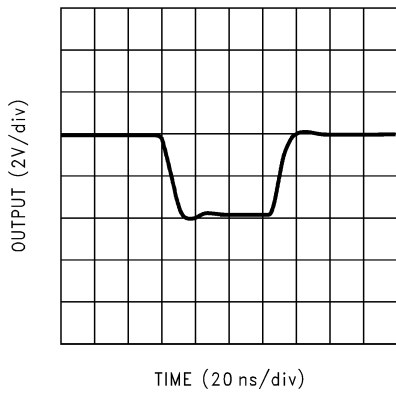

01233648

**Large Signal Pulse Response**  
 $A_V = +1, V_S = \pm 15V$

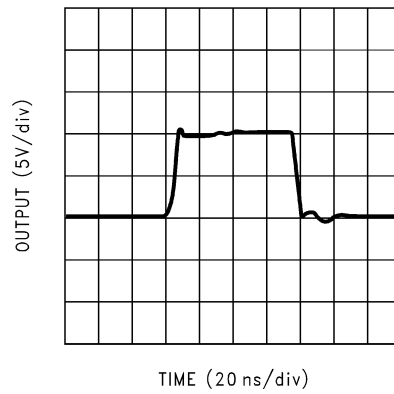

01233649

**Typical Performance Characteristics** Unless otherwise noted,  $T_A = 25^\circ\text{C}$  (Continued)

**Large Signal Pulse Response**  
 $A_V = +1, V_S = \pm 5\text{V}$

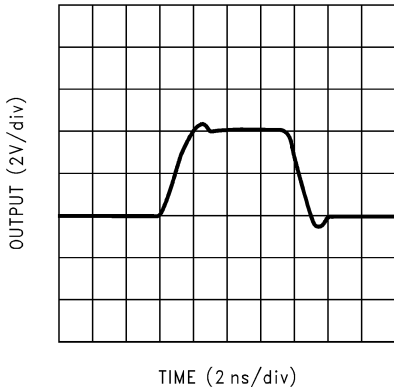

**Large Signal Pulse Response**  
 $A_V = +2, V_S = \pm 15\text{V}$

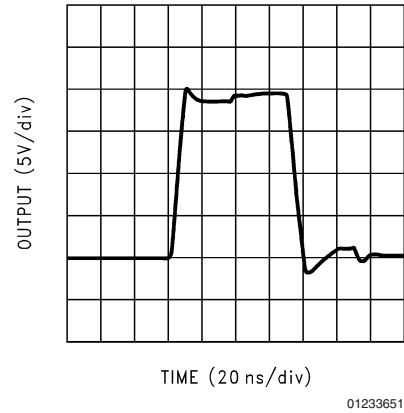

**Large Signal Pulse Response**  
 $A_V = +2, V_S = \pm 5\text{V}$

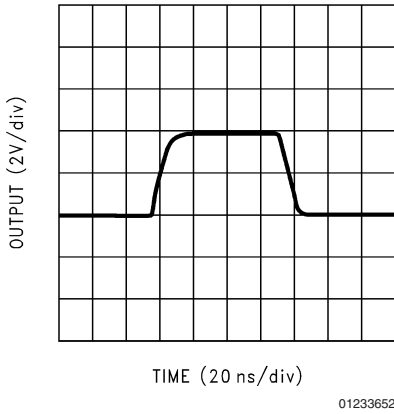

**Small Signal Pulse Response**  
 $A_V = -1, V_S = \pm 15\text{V}$

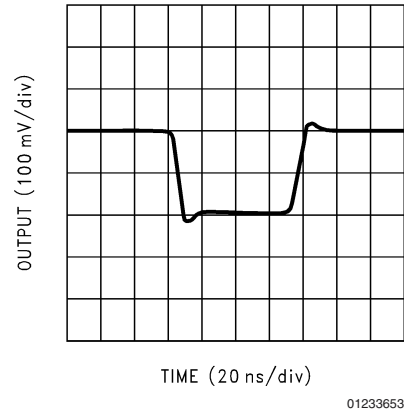

**Small Signal Pulse Response**  
 $A_V = -1, V_S = \pm 5\text{V}$

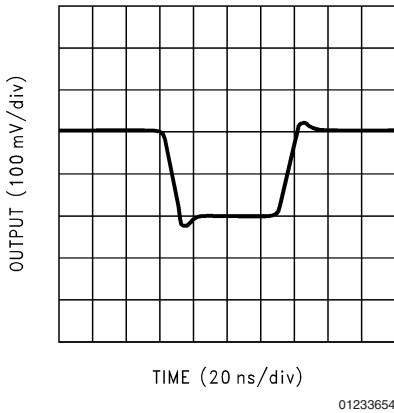

**Small Signal Pulse Response**  
 $A_V = +1, V_S = \pm 15\text{V}$

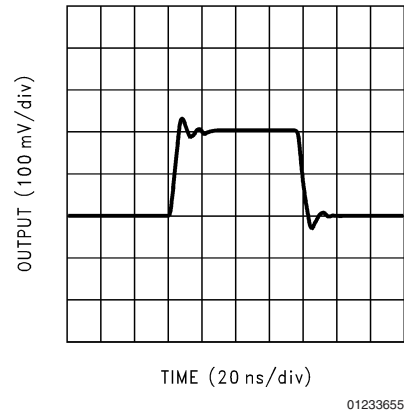

**Typical Performance Characteristics** Unless otherwise noted,  $T_A = 25^\circ\text{C}$  (Continued)

**Small Signal Pulse Response**  
 $A_V = +1, V_S = \pm 5\text{V}$

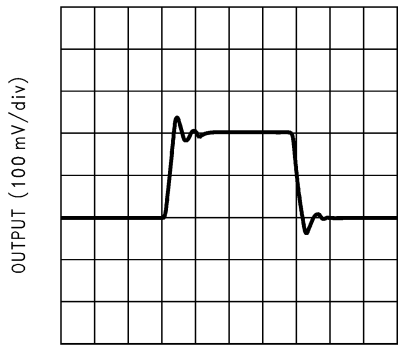

TIME (20 ns/div)

01233656

**Small Signal Pulse Response**  
 $A_V = +2, V_S = \pm 15\text{V}$

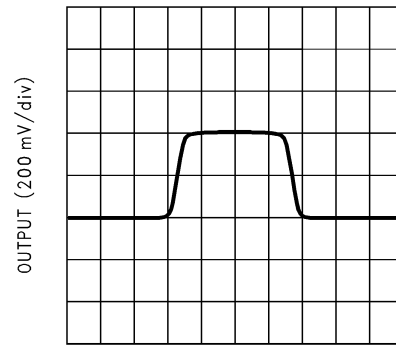

TIME (20 ns/div)

01233657

**Small Signal Pulse Response**  
 $A_V = +2, V_S = \pm 5\text{V}$

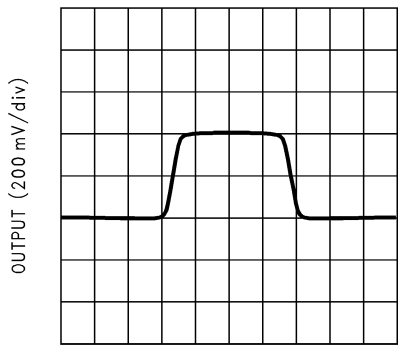

TIME (20 ns/div)

01233658

**Closed Loop Frequency Response vs. Supply Voltage**  
 $(A_V = +1)$

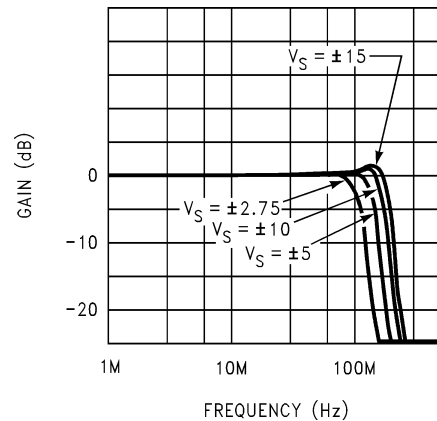

01233659

**Closed Loop Frequency Response vs. Supply Voltage**  
 $(A_V = +2)$

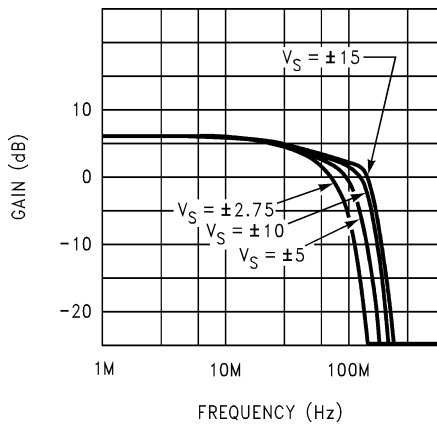

01233660

**Closed Loop Frequency Response vs. Capacitive Load**  
 $(A_V = +1)$

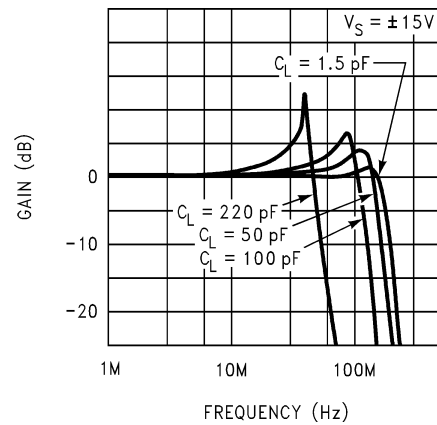

01233661

# Typical Performance Characteristics Unless otherwise noted, $T_A = 25^\circ\text{C}$ (Continued)

**Closed Loop Frequency Response vs. Capacitive Load ( $A_V = +1$ )**

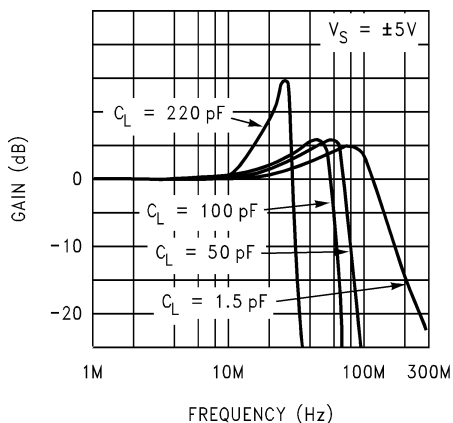

01233662

**Closed Loop Frequency Response vs. Capacitive Load ( $A_V = +2$ )**

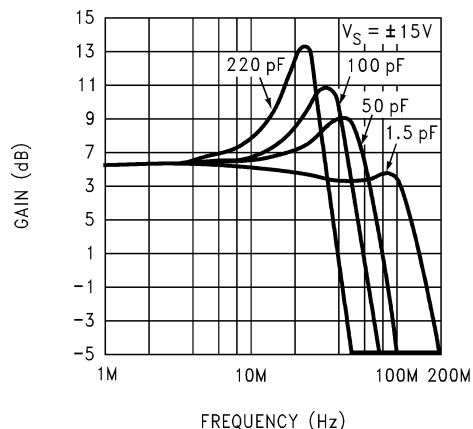

01233663

**Closed Loop Frequency Response vs. Capacitive Load ( $A_V = +2$ )**

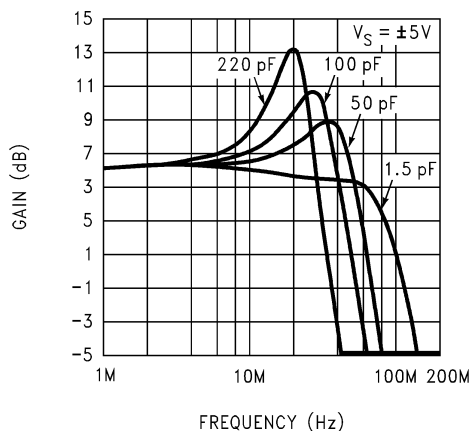

01233664

**Total Harmonic Distortion vs. Frequency**

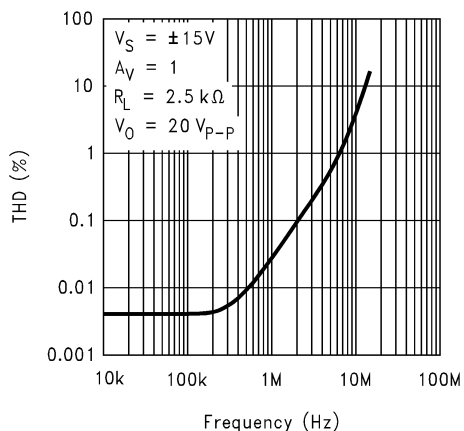

01233665

**Total Harmonic Distortion vs. Frequency**

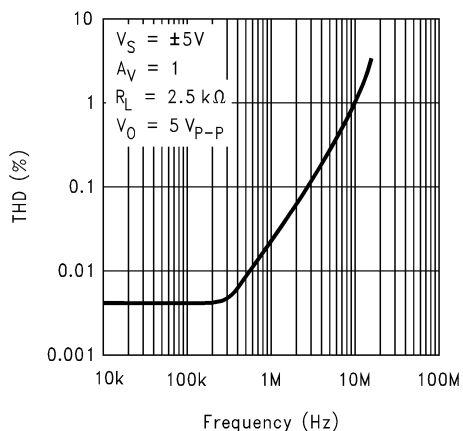

01233666

**Total Harmonic Distortion vs. Frequency**

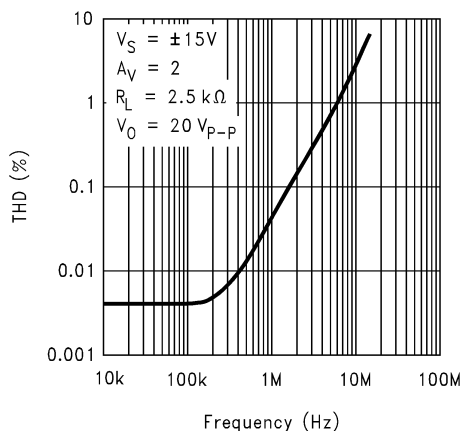

01233667

**Typical Performance Characteristics** Unless otherwise noted,  $T_A = 25^\circ\text{C}$  (Continued)

**Total Harmonic Distortion vs. Frequency**

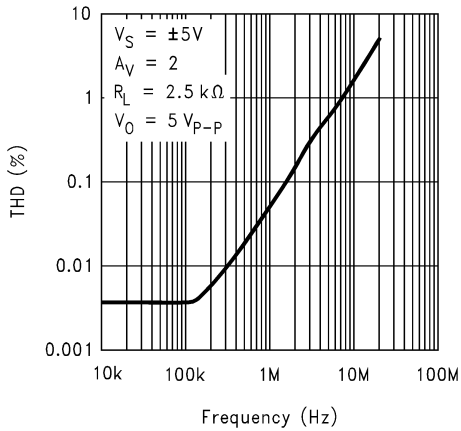

01233668

**Undistorted Output Swing vs. Frequency**

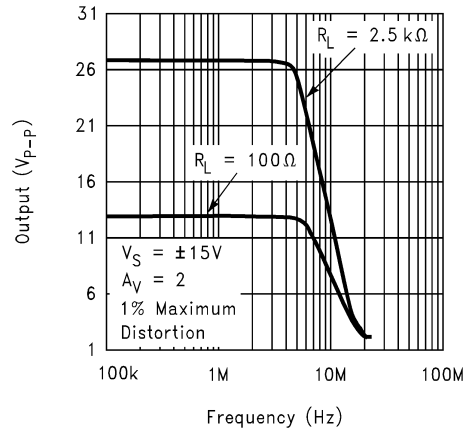

01233669

**Undistorted Output Swing vs. Frequency**

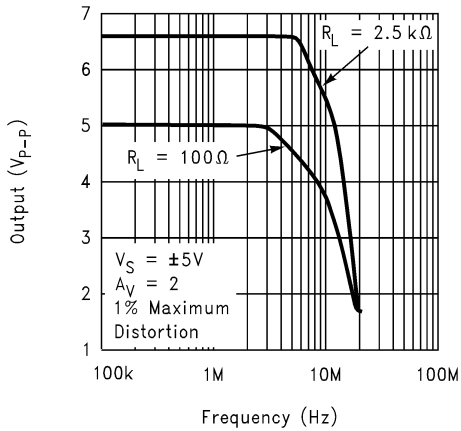

01233670

**Undistorted Output Swing vs. Frequency**

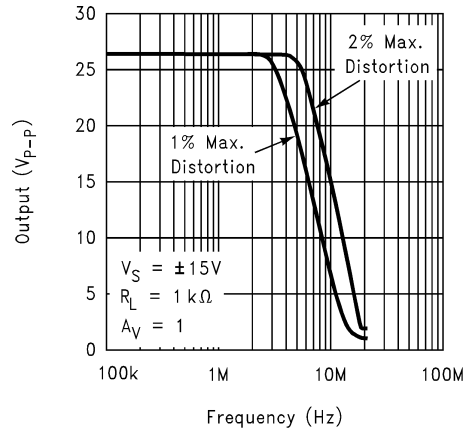

01233671

**Undistorted Output Swing vs. Frequency**

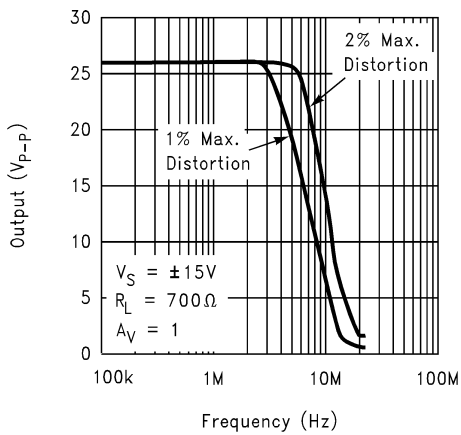

01233672

**Total Power Dissipation vs. Ambient Temperature**

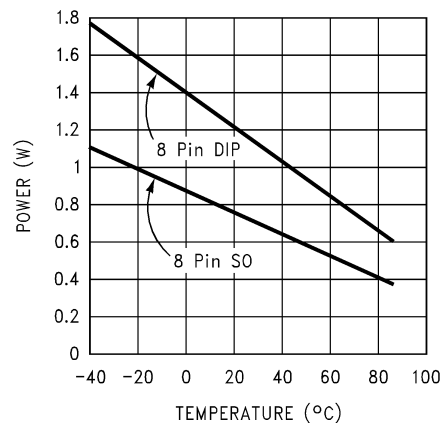

01233673

## LM6171 Simplified Schematic

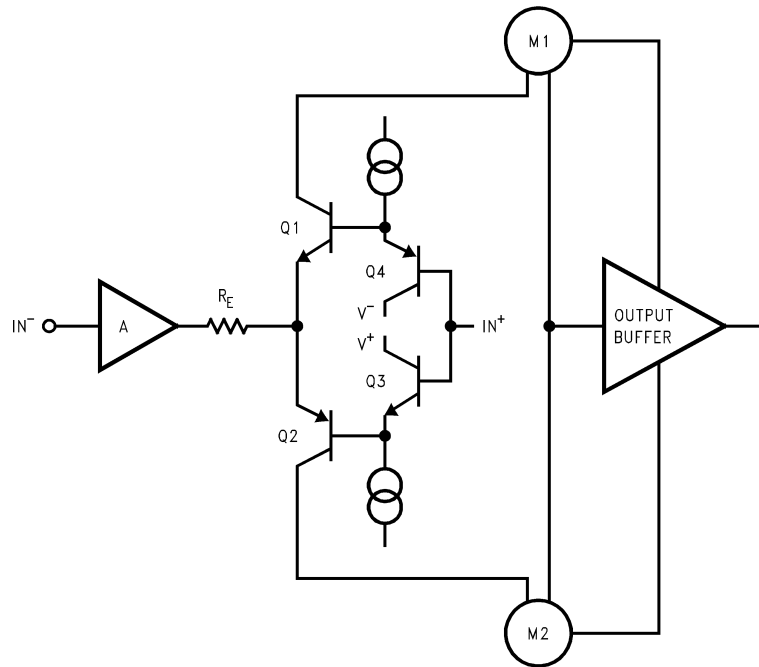

01233610

## Application Information

### LM6171 PERFORMANCE DISCUSSION

The LM6171 is a high speed, unity-gain stable voltage feedback amplifier. It consumes only 2.5 mA supply current while providing a gain-bandwidth product of 100 MHz and a slew rate of 3600V/ $\mu$ s. It also has other great features such as low differential gain and phase and high output current. The LM6171 is a good choice in high speed circuits.

The LM6171 is a true voltage feedback amplifier. Unlike current feedback amplifiers (CFAs) with a low inverting input impedance and a high non-inverting input impedance, both inputs of voltage feedback amplifiers (VFAs) have high impedance nodes. The low impedance inverting input in CFAs will couple with feedback capacitor and cause oscillation. As a result, CFAs cannot be used in traditional op amp circuits such as photodiode amplifiers, I-to-V converters and integrators.

### LM6171 CIRCUIT OPERATION

The class AB input stage in LM6171 is fully symmetrical and has a similar slewing characteristic to the current feedback amplifiers. In the LM6171 Simplified Schematic, Q1 through Q4 form the equivalent of the current feedback input buffer,  $R_E$  the equivalent of the feedback resistor, and stage A buffers the inverting input. The triple-buffered output stage isolates the gain stage from the load to provide low output impedance.

### LM6171 SLEW RATE CHARACTERISTIC

The slew rate of LM6171 is determined by the current available to charge and discharge an internal high impedance node capacitor. The current is the differential input voltage divided by the total degeneration resistor  $R_E$ . Therefore, the slew rate is proportional to the input voltage level, and the higher slew rates are achievable in the lower gain configurations.

When a very fast large signal pulse is applied to the input of an amplifier, some overshoot or undershoot occurs. By placing an external series resistor such as 1 k $\Omega$  to the input of LM6171, the bandwidth is reduced to help lower the overshoot.

### LAYOUT CONSIDERATION

#### Printed Circuit Boards and High Speed Op Amps

There are many things to consider when designing PC boards for high speed op amps. Without proper caution, it is very easy and frustrating to have excessive ringing, oscillation and other degraded AC performance in high speed circuits. As a rule, the signal traces should be short and wide to provide low inductance and low impedance paths. Any unused board space needs to be grounded to reduce stray signal pickup. Critical components should also be grounded at a common point to eliminate voltage drop. Sockets add capacitance to the board and can affect frequency performance. It is better to solder the amplifier directly into the PC board without using any socket.

#### Using Probes

Active (FET) probes are ideal for taking high frequency measurements because they have wide bandwidth, high input impedance and low input capacitance. However, the probe ground leads provide a long ground loop that will produce errors in measurement. Instead, the probes can be grounded directly by removing the ground leads and probe jackets and using scope probe jacks.

#### Components Selection And Feedback Resistor

It is important in high speed applications to keep all component leads short because wires are inductive at high frequency. For discrete components, choose carbon



## Application Information (Continued)

composition-type resistors and mica-type capacitors. Surface mount components are preferred over discrete components for minimum inductive effect.

Large values of feedback resistors can couple with parasitic capacitance and cause undesirable effects such as ringing or oscillation in high speed amplifiers. For LM6171, a feedback resistor of 510Ω gives optimal performance.

### COMPENSATION FOR INPUT CAPACITANCE

The combination of an amplifier's input capacitance with the gain setting resistors adds a pole that can cause peaking or oscillation. To solve this problem, a feedback capacitor with a value

$$C_F > (R_G \times C_{IN})/R_F$$

can be used to cancel that pole. For LM6171, a feedback capacitor of 2 pF is recommended. *Figure 1* illustrates the compensation circuit.

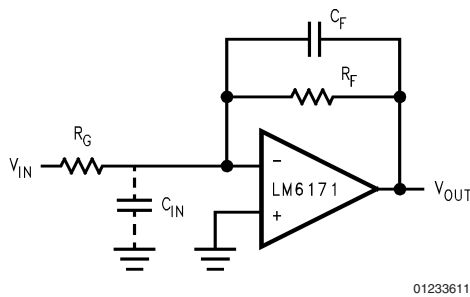

01233611

FIGURE 1. Compensating for Input Capacitance

### POWER SUPPLY BYPASSING

Bypassing the power supply is necessary to maintain low power supply impedance across frequency. Both positive and negative power supplies should be bypassed individually by placing 0.01 μF ceramic capacitors directly to power supply pins and 2.2 μF tantalum capacitors close to the power supply pins.

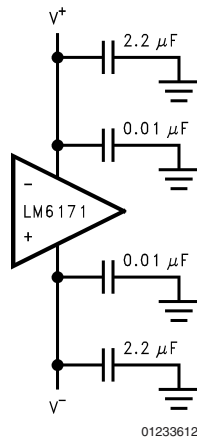

01233612

FIGURE 2. Power Supply Bypassing

### TERMINATION

In high frequency applications, reflections occur if signals are not properly terminated. *Figure 3* shows a properly terminated signal while *Figure 4* shows an improperly terminated signal.

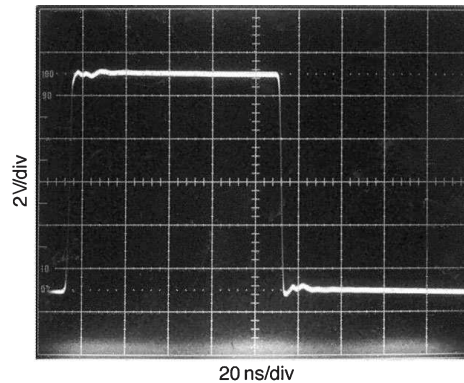

01233614

FIGURE 3. Properly Terminated Signal

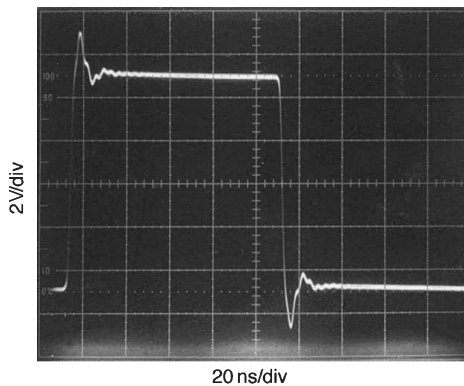

01233615

FIGURE 4. Improperly Terminated Signal

## Application Information (Continued)

To minimize reflection, coaxial cable with matching characteristic impedance to the signal source should be used. The other end of the cable should be terminated with the same value terminator or resistor. For the commonly used cables, RG59 has 75Ω characteristic impedance, and RG58 has 50Ω characteristic impedance.

### DRIVING CAPACITIVE LOADS

Amplifiers driving capacitive loads can oscillate or have ringing at the output. To eliminate oscillation or reduce ringing, an isolation resistor can be placed as shown below in *Figure 5*. The combination of the isolation resistor and the load capacitor forms a pole to increase stability by adding more phase margin to the overall system. The desired performance depends on the value of the isolation resistor; the bigger the isolation resistor, the more damped the pulse response becomes. For LM6171, a 50Ω isolation resistor is recommended for initial evaluation. *Figure 6* shows the LM6171 driving a 200 pF load with the 50Ω isolation resistor.

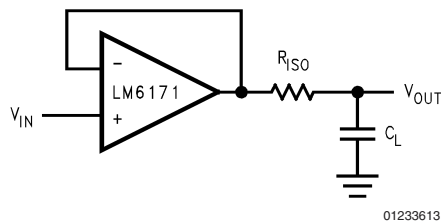

FIGURE 5. Isolation Resistor Used to Drive Capacitive Load

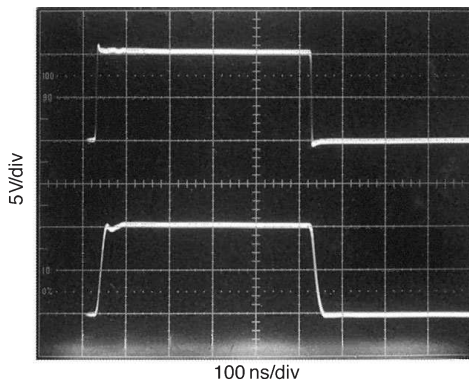

FIGURE 6. The LM6171 Driving a 200 pF Load with a 50Ω Isolation Resistor

### POWER DISSIPATION

The maximum power allowed to dissipate in a device is defined as:

$$P_D = (T_{J(max)} - T_A) / \theta_{JA}$$

Where  $P_D$  is the power dissipation in a device

$T_{J(max)}$  is the maximum junction temperature

$T_A$  is the ambient temperature

$\theta_{JA}$  is the thermal resistance of a particular package

For example, for the LM6171 in a SO-8 package, the maximum power dissipation at 25°C ambient temperature is 730 mW.

Thermal resistance,  $\theta_{JA}$ , depends on parameters such as die size, package size and package material. The smaller the die size and package, the higher  $\theta_{JA}$  becomes. The 8-pin DIP package has a lower thermal resistance (108°C/W) than that of 8-pin SO (172°C/W). Therefore, for higher dissipation capability, use an 8-pin DIP package.

The total power dissipated in a device can be calculated as:

$$P_D = P_Q + P_L$$

$P_Q$  is the quiescent power dissipated in a device with no load connected at the output.  $P_L$  is the power dissipated in the device with a load connected at the output; it is not the power dissipated by the load.

Furthermore,

$P_Q$  = supply current x total supply voltage with no load

$P_L$  = output current x (voltage difference between supply voltage and output voltage of the same supply)

For example, the total power dissipated by the LM6171 with  $V_S = \pm 15V$  and output voltage of 10V into 1 kΩ load resistor (one end tied to ground) is

$$\begin{aligned} P_D &= P_Q + P_L \\ &= (2.5 \text{ mA}) \times (30V) + (10 \text{ mA}) \times (15V - 10V) \\ &= 75 \text{ mW} + 50 \text{ mW} \\ &= 125 \text{ mW} \end{aligned}$$

### APPLICATION CIRCUITS

#### Fast Instrumentation Amplifier

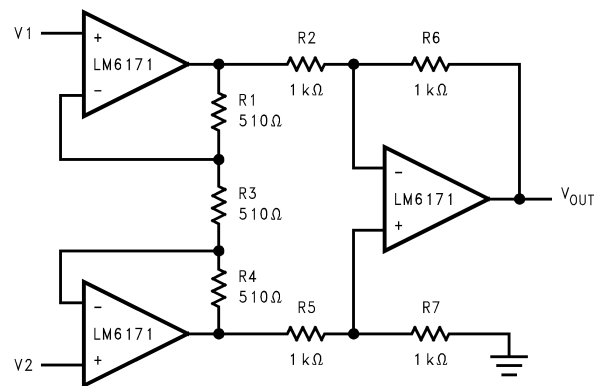

$$V_{IN} = V_2 - V_1$$

$$\text{if } R_6 = R_2, R_7 = R_5 \text{ and } R_1 = R_4$$

$$\frac{V_{OUT}}{V_{IN}} = \frac{R_6}{R_2} \left( 1 + 2 \frac{R_1}{R_3} \right) = 3$$

## Application Information (Continued)

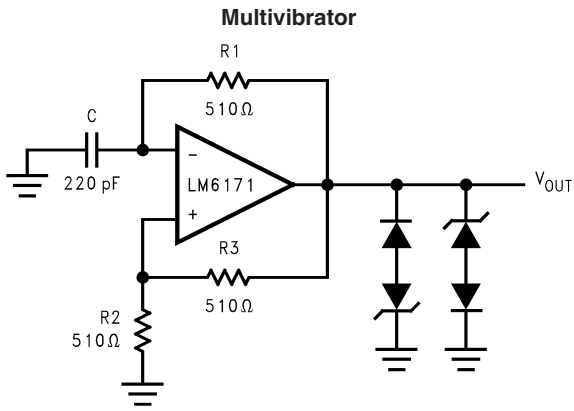

01233618

$$f = \frac{1}{2 \left( R1C \ln \left( 1 + 2 \frac{R2}{R3} \right) \right)}$$

$f = 4 \text{ MHz}$

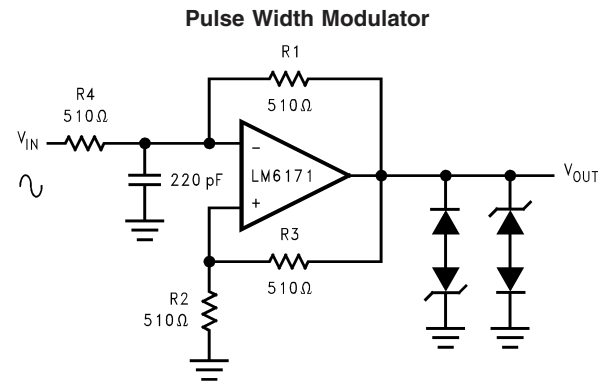

01233619

### DESIGN KIT

A design kit is available for the LM6171. The design kit contains:

- High Speed Evaluation Board
- LM6171 in 8-pin DIP Package
- LM6171 Datasheet
- Pspice Macromodel Diskette With the LM6171 Macromodel
- An Amplifier Selection Guide

### PITCH PACK

A pitch pack is available for the LM6171. The pitch pack contains:

- High Speed Evaluation Board

- LM6171 in 8-pin DIP Package
- LM6171 Datasheet
- Pspice Macromodel Diskette With the LM6171 Macromodel

Contact your local National Semiconductor sales office to obtain a pitch pack.

**Physical Dimensions** inches (millimeters) unless otherwise noted

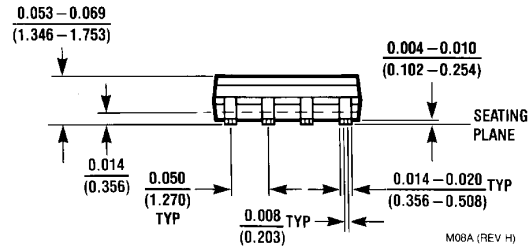
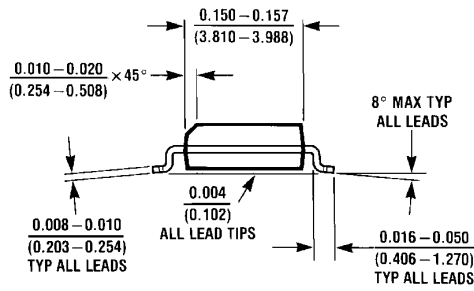
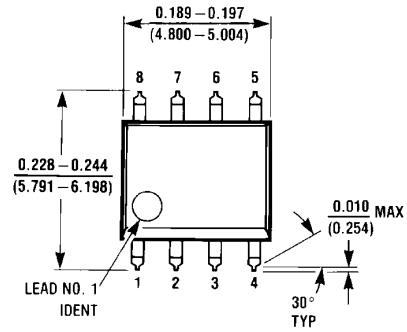

**8-Pin Small Outline Package  
NS Package Number M08A**

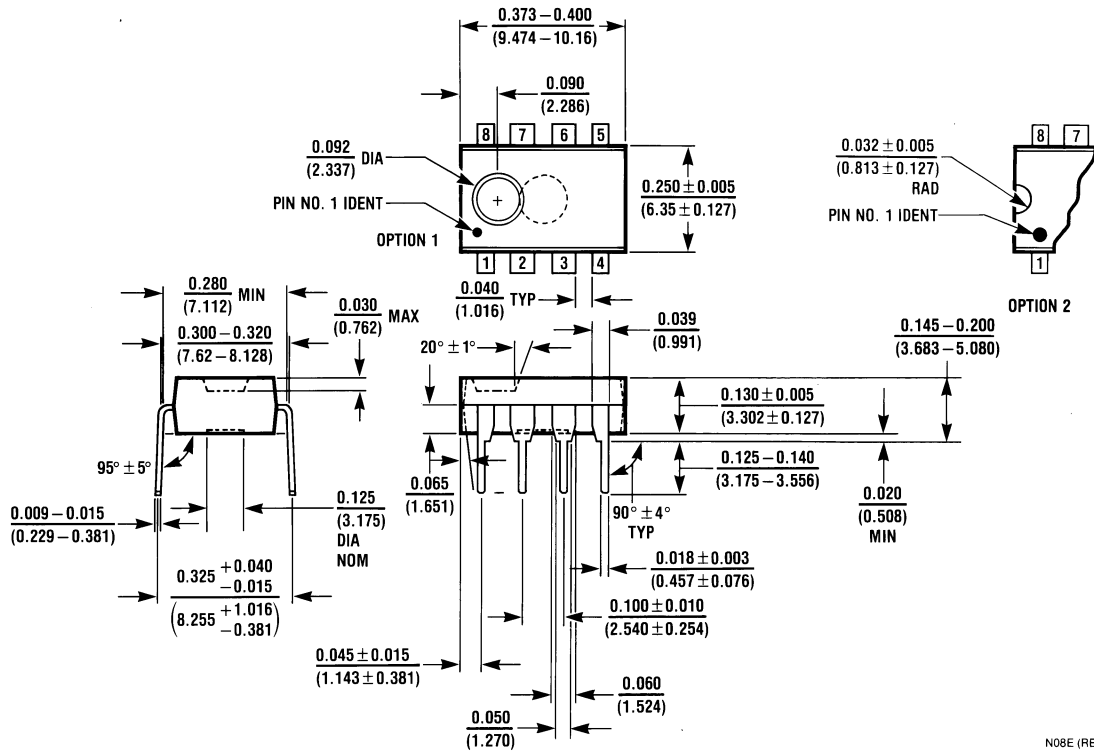

**8-Pin Molded DIP Package  
NS Package Number N08E**

## Notes

### LIFE SUPPORT POLICY

NATIONAL'S PRODUCTS ARE NOT AUTHORIZED FOR USE AS CRITICAL COMPONENTS IN LIFE SUPPORT DEVICES OR SYSTEMS WITHOUT THE EXPRESS WRITTEN APPROVAL OF THE PRESIDENT AND GENERAL COUNSEL OF NATIONAL SEMICONDUCTOR CORPORATION. As used herein:

1. Life support devices or systems are devices or systems which, (a) are intended for surgical implant into the body, or (b) support or sustain life, and whose failure to perform when properly used in accordance with instructions for use provided in the labeling, can be reasonably expected to result in a significant injury to the user.
2. A critical component is any component of a life support device or system whose failure to perform can be reasonably expected to cause the failure of the life support device or system, or to affect its safety or effectiveness.



**National Semiconductor**  
Americas Customer  
Support Center  
Email: new.feedback@nsc.com  
Tel: 1-800-272-9959

[www.national.com](http://www.national.com)

**National Semiconductor**  
Europe Customer Support Center  
Fax: +49 (0) 180-530 85 86  
Email: europe.support@nsc.com  
Deutsch Tel: +49 (0) 69 9508 6208  
English Tel: +44 (0) 870 24 0 2171  
Français Tel: +33 (0) 1 41 91 8790

**National Semiconductor**  
Asia Pacific Customer  
Support Center  
Fax: +65-6250 4466  
Email: ap.support@nsc.com  
Tel: +65-6254 4466

**National Semiconductor**  
Japan Customer Support Center  
Fax: 81-3-5639-7507  
Email: jpn.feedback@nsc.com  
Tel: 81-3-5639-7560

This datasheet has been download from:

[www.datasheetcatalog.com](http://www.datasheetcatalog.com)

Datasheets for electronics components.

# National Semiconductor was acquired by Texas Instruments.

[http://www.ti.com/corp/docs/investor\\_relations/pr\\_09\\_23\\_2011\\_national\\_semiconductor.html](http://www.ti.com/corp/docs/investor_relations/pr_09_23_2011_national_semiconductor.html)

This file is the datasheet for the following electronic components:

LM6171BIN - <http://www.ti.com/product/lm6171bin?HQS=TI-null-null-dscatalog-df-pf-null-wwe>

LM6171BI MDA - [http://www.ti.com/product/lm6171bi\\_mda?HQS=TI-null-null-dscatalog-df-pf-null-wwe](http://www.ti.com/product/lm6171bi_mda?HQS=TI-null-null-dscatalog-df-pf-null-wwe)

LM6171BI MWA - [http://www.ti.com/product/lm6171bi\\_mwa?HQS=TI-null-null-dscatalog-df-pf-null-wwe](http://www.ti.com/product/lm6171bi_mwa?HQS=TI-null-null-dscatalog-df-pf-null-wwe)

LM6171BIMX - <http://www.ti.com/product/lm6171bimx?HQS=TI-null-null-dscatalog-df-pf-null-wwe>

LM6171BIM - <http://www.ti.com/product/lm6171bim?HQS=TI-null-null-dscatalog-df-pf-null-wwe>

LM6171AIM - <http://www.ti.com/product/lm6171aim?HQS=TI-null-null-dscatalog-df-pf-null-wwe>

LM6171AIMX - <http://www.ti.com/product/lm6171aimx?HQS=TI-null-null-dscatalog-df-pf-null-wwe>